

American Thoracic Society/ American College of Chest Physicians

ATS/ACCP Statement on Cardiopulmonary Exercise Testing

THIS JOINT STATEMENT OF THE AMERICAN THORACIC SOCIETY (ATS) AND THE AMERICAN COLLEGE OF CHEST PHYSICIANS (ACCP) WAS ADOPTED BY THE ATS BOARD OF DIRECTORS, MARCH 1, 2002 AND BY THE ACCP HEALTH SCIENCE POLICY COMMITTEE, NOVEMBER 1, 2001

CONTENTS

Executive Summary

I. Introduction

Idelle M. Weisman
Purpose and Scope 212

II. Indications for Cardiopulmonary Exercise Testing

Idelle M. Weisman, Darcy Marciniuk, Fernando J. Martinez,
Frank Sciruba, Darryl Sue, Jonathan Myers

1. Evaluation of Exercise Intolerance 214
2. Unexplained Dyspnea 215
3. Evaluation of Patients with Cardiovascular Disease . . . 215
4. Evaluation of Patients with Respiratory Disease . . . 216
 - 4.1 Chronic Obstructive Pulmonary Disease (COPD)
 - 4.2 Interstitial Lung Disease (ILD)
 - 4.3 Chronic Pulmonary Vascular Disease (PVD)
 - 4.4 Cystic Fibrosis
 - 4.5 Exercise Induced Bronchospasm (EIB)
5. Preoperative Evaluation 216
 - 5.1 Preoperative Evaluation for Lung Cancer Resectional Surgery
 - 5.2 Lung Volume Reduction Surgery (LVRS)
 - 5.3 Evaluation for Lung or Heart-Lung Transplantation
 - 5.4 Preoperative Evaluation of Other Procedures
6. Exercise Prescription for Pulmonary Rehabilitation . . 217
7. Evaluation of Impairment/Disability 217

III. Methodology

Richard Casaburi, Darcy Marciniuk, Ken Beck, Jorge Zeballos,
George Swanson, Jonathan Myers, Frank Sciruba

1. Equipment and Methodology 218
 - 1.1 Exercise Equipment
 - 1.2 Airflow or Volume Transducers
 - 1.3 Gas Analyzers
 - 1.4 Gas Exchange Measurements ($\dot{V}O_2$ and $\dot{V}CO_2$)
 - 1.5 Electrocardiograph
 - 1.6 Non Invasive Blood Pressure
 - 1.7 Intraarterial Blood Pressure
 - 1.8 Pulse Oximetry
 - 1.9 Calibration Procedures/Quality Control
 - 1.10 Reproducibility of the Measurements
2. Exercise Test with Arterial Blood Sampling 224
3. Exercise Testing Protocols 224
 - 3.1 Maximal Incremental Cycle Ergometry Protocols (IET)

- 3.2 Maximal Incremental Treadmill Protocols
- 3.3 Constant Work Rate Protocol
4. Conducting the Test 226
 - 4.1 Preliminary Requirements for Exercise Testing
 - 4.2 Day of the Test
 - 4.3 Patient Safety
5. Personnel Qualifications 227

IV. Conceptual and Physiologic Basis of Cardiopulmonary Exercise Testing Measurements

Bruce Johnson, Brian Whipp, Jorge Zeballos, Idelle M. Weisman,
Ken Beck, Donald Mahler, John Cotes, Kathy Sietsema,
Kieran Killian

1. Oxygen Uptake 228
 - 1.1 $\dot{V}O_2$ Work Rate Relationship
 - 1.2 $\dot{V}O_2$ max- $\dot{V}O_2$ peak
2. CO_2 Output 229
3. Respiratory Exchange Ratio 230
4. Anaerobic Threshold 230
 - 4.1 Clinical Applications of the Anaerobic Threshold
 - 4.2 Determination of the Anaerobic Threshold
 - 4.3 Noninvasive Determinations
5. Cardiac Output 232
 - 5.1 Heart Rate, HR- $\dot{V}O_2$ Relationship
 - 5.2 O_2 Pulse
6. Blood Pressure Response 233
7. Ventilation 233
 - 7.1 Breathing Pattern and Ventilatory Timing
 - 7.2 Ventilatory Demand/Capacity
 - 7.3 Ventilatory Reserve
 - 7.4 Relationship of \dot{V}_E vs. $\dot{V}O_2$ and \dot{V}_E vs. $\dot{V}CO_2$
 - 7.5 Ventilatory Equivalents for $\dot{V}O_2$ and $\dot{V}CO_2$
 - 7.6 End-Tidal PO_2 and PCO_2
8. Emerging Techniques to Evaluate Ventilatory
Limitation 235
 - 8.1 Maximal Exercise Ventilation (\dot{V}_{Ecap})
 - 8.2 Negative Expiratory Pressure (NEP)
9. Respiratory Muscle Evaluation 237
10. Pulmonary Gas Exchange 237
 - 10.1 Alveolar-Arterial PO_2 Pressure difference ($PA_{O_2}-Pa_{O_2}$) and Pa_{O_2}
 - 10.2 Physiological Dead Space-to-Tidal Volume Ratio (V_D/V_T)
11. Perceptual Assessment—Symptoms 238

V. Reference Values

Jorge Zeballos, John Cotes, Mary S. Fairbairn, Robert O. Crapo

1. Requirements for an Optimal Set of Normal Reference
Values 239
 - 1.1 Population Characteristics
 - 1.2 Sample Size
 - 1.3 Randomization

This version of the Statement contains the corrections outlined in the May 15 Erratum Letter to the Editor (*Am J Respir Crit Care Med* 2003;167:1451-1452)

Am J Respir Crit Care Med Vol 167, pp 211-277, 2003
DOI: 10.1164/rccm.167.2.211
Internet address: www.atsjournals.org

1.4 Quality Assurance	
1.5 CPET Protocols	
1.6 Treatment of the Data	
1.7 Validation	
1.8 Statistical Treatment of the Data	
2. Alternative Approach to Obtain Normal Reference Values	239
3. Evaluation and Critique of the Most Current Reference Values	239
4. Reference Values for Submaximal Levels of Exercise	240
5. Reference Values for Arterial Blood Gases, P(A-a)O ₂ , and V _D /V _T during CPET	241
6. Practical Approach for the Selection of Reference Values	242

VI. Normal Integrative Exercise Response

Bruce Johnson, Peter D. Wagner, Jerome Dempsey
Normal Exercise Limitation

VII. Exercise Limitation in Cardiopulmonary Patients

Bruce Johnson, Peter D. Wagner, Jorge Zeballos, Idelle M. Weisman

VIII. Interpretation

Idelle M. Weisman, Charles G. Gallagher, Fernando J. Martinez, Jonathan Myers, Darcy Marciniuk

1. Introduction	243
2. Interpretative Strategies	243
3. Integrative Approach: Important Issues to Be Addressed	244
3.1 Reason(s) for CPET	
3.2 Clinical Status Evaluation	
3.3 Compare Results with Appropriate Reference Values	
3.4 Measurements and Graphic Interrelationships	
3.5 Symptoms	
3.6 Data Presentation	
3.7 Assessment of Patient Effort	
3.8 Reasons for Stopping	
4. Patterns of Exercise Response in Different Clinical Entities	246
4.1 Heart Failure	
4.2 Pulmonary Vascular Disease	
4.3 Deconditioning	
4.4 COPD	
4.5 ILD	
4.6 Obesity	
4.7 Psychogenic (Anxiety, Hyperventilation Syndrome)	
4.8 Poor Effort and Malingering	
5. Important Questions	251
5.1 Is Exercise Capacity (V _O ₂ peak) normal?	
5.2 Is Metabolic Rate Appropriate During Exercise?	
5.3 Does Cardiovascular Function Contribute to Exercise Limitation?	
5.4 Does Ventilatory Function Contribute to Exercise Limitation?	
5.5 Does Pulmonary Gas Exchange Contribute to Exercise Limitation?	
5.6 Is There Premature Metabolic Acidosis?	
6. Putting It All Together	253
7. Case Studies	253
7.1 Normal CPET Response	
7.2 CPET in a Patient with Dilated Cardiomyopathy	
7.3 CPET in a Patient with COPD	
7.4 CPET in a Patient with ILD	
7.5 CPET in a Patient with Pulmonary Vascular Disease	

IX. Recommendations for Future Studies

X. Glossary

EXECUTIVE SUMMARY

Cardiopulmonary exercise testing (CPET) provides a global assessment of the integrative exercise responses involving the pulmonary, cardiovascular, hematopoietic, neuropsychological, and skeletal muscle systems, which are not adequately reflected through the measurement of individual organ system function. This relatively noninvasive, dynamic physiologic overview permits the evaluation of both submaximal and peak exercise responses, providing the physician with relevant information for clinical decision making. Once the exclusive province of research physiologists and specialized centers, CPET is increasingly being used in a wide spectrum of clinical applications for the evaluation of undiagnosed exercise intolerance and exercise-related symptoms, and for the objective determination of functional capacity and impairment. The use of CPET in patient management is increasing with the understanding that resting pulmonary and cardiac function testing cannot reliably predict exercise performance and functional capacity and that, furthermore, overall health status correlates better with exercise tolerance rather than with resting measurements.

Introduction

The purpose of this Joint American Thoracic Society/American College of Chest Physicians (ATS/ACCP) statement is to provide a comprehensive, conceptually balanced document on CPET, which formulates guidelines and recommendations to facilitate interpretation and clinical application on the basis of the current best scientific knowledge and technical advances. The focus of this document is on clinical indications, standardization issues, and interpretative strategies for CPET in adults. The scope of issues includes (1) indications for CPET; (2) methodology—equipment, modality, protocols, conduct of the test, monitoring, safety, and personnel issues; (3) measurements and graphic interrelationships, the physiologic response to exercise in “normal” subjects, and the consequences of pathophysiologic derangements on exercise performance; (4) normal reference values; (5) interpretation, including case study analysis; and (6) future recommendations for research. The intended audience for this document includes those who perform clinical CPET, and also those who use these results to assist in the clinical decision-making process.

The Joint ATS/ACCP Ad Hoc Committee on Cardiopulmonary Exercise Testing included an international group of acknowledged experts with a broad range of clinical and research expertise and conceptual orientations. A comprehensive literature search using Medline from 1970 through 2002, and relevant publications selected by the committee members, were used. In this document, recommendations are based on best available evidence, current prevailing scientific knowledge, and expert opinion. The committee attempted to identify areas of controversy and to note clearly those areas where recommendations did not achieve clear consensus, and where alternative approaches were possible.

Indications for Cardiopulmonary Exercise Testing

There are a number of specific indications for CPET (*see* Table 1). These include the following:

1. Evaluation of exercise tolerance
2. Evaluation of undiagnosed exercise intolerance
3. Evaluation of patients with cardiovascular diseases
4. Evaluation of patients with respiratory diseases/symptoms
5. Preoperative evaluation
6. Exercise evaluation and prescription for pulmonary rehabilitation
7. Evaluation of impairment/disability
8. Evaluation for lung, heart, and heart–lung transplantation

In practice, CPET should be considered when specific questions remain unanswered after consideration of basic clinical data including history, physical examination, chest radiographs, resting pulmonary function tests, and resting electrocardiogram (ECG).

Methodology

Two modes of exercise are commonly employed in cardiopulmonary exercise tests: treadmill and cycle ergometer. In most clinical circumstances, cycle ergometry is the preferable mode of exercise; however, depending on the reason(s) for which CPET was requested and equipment availability, a treadmill may be an acceptable alternative (*see* Table 2). Although there are many computerized systems for data collection and analysis available for the clinical laboratory (*see* Table 3 and Figures 1 and 2), it is important that the methods used be validated, that appropriate calibration be performed, and that quality assurance be undertaken and maintained (*see* Tables 4 and 5).

Although manufacturers bear the responsibility for demonstrating that cardiopulmonary exercise testing systems purchased are accurate and precise, the user bears the responsibility for assuring that measurements remain accurate. Cardiopulmonary exercise testing, especially when it features breath-by-breath gas exchange analysis, requires meticulous attention to calibration procedures to assure accurate and reproducible measurements. A good practice is to calibrate the system daily and also to maintain a calibration logbook so that long-term trends can be monitored. In addition, a physiologic calibration in which (a) healthy member(s) of the laboratory staff perform(s) a constant work rate test at several workloads at regular intervals should be routinely undertaken. Subsequent steady state values for minute ventilation (\dot{V}_E), oxygen uptake (\dot{V}_{O_2}), or carbon dioxide output (\dot{V}_{CO_2}) are then compared with the database and values outside of the established 95% confidence interval (CI) for that individual should engender a thorough system-wide reassessment. If within tolerance, they are then added to the quality control database.

There are several protocols that can be used with either a cycle ergometer or a treadmill. Although the incremental protocol is most widely used in clinical practice, constant work rate protocols are gaining popularity because of their clinical applicability, particularly for monitoring response(s) to therapy.

CPET is a safe procedure, with the risk of death for patients between 2 and 5 per 100,000 exercise tests performed. For all tests, attention to patient safety is of the utmost importance. Only qualified personnel should supervise testing. These trained individuals should be knowledgeable about the conduct (*see* Table 7) and risks of testing, contraindications to testing (*see* Table 8), and the criteria for terminating exercise tests (*see* Table 9). Appropriate patient and equipment preparation must also be undertaken, along with measures to ensure that factors affecting the validity and reproducibility of measured exercise responses are meticulously controlled (*see* Table 7).

Conceptual and Physiologic Basis of Cardiopulmonary Exercise Testing Measurements

An impressive number of variables is typically measured or derived during CPET (*see* Table 10). The utility of many of these measurements is well known, while for others, their clinical usefulness is yet not settled. The value of many newer techniques is also still being actively investigated (*see* Figures 5–9). Importantly, both physiologic and perceptual responses during exercise should be collected and utilized for interpretation (*see* Tables 10 and 11). The measurement, clinical utility, strengths, and limitations for all individual measurements, including the reproducibility of variables measured during CPET (*see* Table 6), are further discussed in detail in this document.

It must be emphasized that for optimal interpretation, the greatest diagnostic potential and impact on clinical decision making rests not on the utility of any one individual measurement, but rather on the integrated use of these variables.

Reference Values

The selection of normal reference values for use in the evaluation of CPET results is critical to any interpretative scheme. Normal reference values provide the comparative basis for answering important questions concerning the normalcy of exercise responses in patients, significantly impacting the clinical decision-making process. Standardization of normal reference values processes and practices for CPET is necessary to facilitate accurate interpretation and optimize clinical value.

When selecting reference values from the literature, a number of factors should be considered, including the following: the study sample size and randomization, quality assurance and CPET protocols, data validation, and statistical interpretation of the data set. In the end, each clinical exercise laboratory must select an appropriate set of reference values that best reflects the characteristics of their population tested, and the equipment and methodology utilized. A discussion and critique of currently available reference values for both peak (maximal) and submaximal exercise is outlined in this document (*see* Tables 12–15).

Interpretation

Various interacting factors are potentially responsible for the mechanism(s) of exercise limitation in individuals. However, the essential issue is not “what is the limiting factor to maximal exercise,” but rather “what is the potential relative importance of each of the factors involved in the exercise response.” For normal humans, it appears there is no single exercise-limiting factor; the heart with contribution of muscle, rather than lungs and blood, is largely responsible for exercise limitation, training effects, and differences in exercise capacity between people.

Conversely, it is increasingly appreciated that exercise limitation in patients with reduced maximal oxygen consumption ($\dot{V}_{O_2\max}$) is complex, often multifactorial, and as such not limited by any single component of the O_2 transport/utilization process, but rather by their collective quantitative interaction(s). Furthermore, in contrast to normal subjects, in whom physiologic limitation to O_2 transport may be evident, patients are often symptom limited, and may stop exercise before reaching physiologic limits of metabolic or gas transport capacity. The presence of deconditioning in many patients and normal humans has increased awareness of the role of peripheral limitation (skeletal muscle dysfunction) in exercise performance, and the importance of considering deconditioning as a contributing factor in their symptoms and in their exercise limitation.

Algorithms based on a single key measurement and conceptual framework may be helpful in differential diagnosis, but are limited by excessive reliance on a single measurement. Algorithms are also often inadequate for the evaluation of early or mild disease as well as combined disease (i.e., cardiac–pulmonary). Furthermore, although many differing interpretative algorithms have been developed, none have been clinically validated. As such, an integrative approach to CPET interpretation, which emphasizes the interrelationships, trending phenomena, and patterns of key variable responses in a clinical setting, is recommended for use in CPET laboratories (*see* Figure 10).

Issues to be addressed in the interpretation of CPET include (*see* Table 16) the following: indications(s) for testing, associated clinical evaluation and information, assessment of the quality of exercise data collected, comparison of measured graphic and tabular responses with appropriate normal reference values, assessment of symptoms and reason(s) for stopping exercise, correlation of exercise results with the clinical information available

for the patient, and, finally, preparation of an exercise report. A suggested tabular and graphic report is presented in this document, emphasizing the importance of submaximal data and trending phenomenon. Suggested normal guidelines for interpretation of a maximal cardiopulmonary exercise test are provided (see Table 17).

If exercise responses vary from expected, then comparison with typical CPET response patterns noted with several clinical entities and diseases should be undertaken (see Table 18). It must be appreciated that significant overlap exists in the exercise responses of patients with different respiratory and cardiac diseases, and that patients often have multiple, coexisting conditions. There is also significant variability noted for exercise responses in normal subjects. However, typically, one or more responses often predominate, allowing prioritization of contributing factors to a patient's symptoms and/or exercise impairment. In this regard, important specific questions to address are as follows: is aerobic capacity (peak $\dot{V}O_2$) normal? Does cardiovascular function contribute to exercise limitation? Does ventilatory function contribute to exercise limitation? Does pulmonary gas exchange contribute to exercise limitation? Is there premature acidosis? The integrative approach to cardiopulmonary exercise testing is highlighted in five fully discussed case studies (see Tables 19–23 and Figures 11–15).

Recommendations for Future Studies

To increase the clinical utility of CPET, and to validate new and evolving technologies, additional research and understanding are necessary. For instance, further study is required in the development of reference values and specific protocols, particularly the role of constant work tests. Similarly, additional research is also necessary to advance a more evidenced-based approach to the interpretation of CPET. Specific areas for future work are listed and discussed in the text of the document.

I. INTRODUCTION

Once the exclusive province of research physiologists and specialized centers, cardiopulmonary exercise testing (CPET) is increasingly being used in a wide spectrum of clinical applications for the evaluation of undiagnosed exercise intolerance, exercise-related symptoms, and, uniquely, for the objective determination of functional capacity and impairment. CPET involves the measurement of respiratory gas exchange: oxygen uptake ($\dot{V}O_2$), carbon dioxide output ($\dot{V}CO_2$), and minute ventilation (\dot{V}_E), in addition to monitoring electrocardiography, blood pressure, and pulse oximetry, typically during a symptom-limited maximal progressive exercise tolerance test; in some situations a constant work rate protocol may also be used (see Section III: METHODOLOGY). When appropriate, arterial sampling is also performed and provides more detailed, important information about pulmonary gas exchange.

CPET provides a global assessment of the integrative exercise response involving the pulmonary, cardiovascular, hematopoietic, neuropsychologic, and skeletal muscle systems that is not adequately reflected through the measurement of individual organ system function (see Section II: INDICATIONS FOR CARDIOPULMONARY EXERCISE TESTING). This relatively noninvasive, dynamic, physiologic overview permits the evaluation of both submaximal and peak exercise responses and provides relevant information for clinical decision making.

Increasing use of CPET has been fueled by advances in technology including the development of automated exercise systems with enhanced data acquisition and management and subject-monitoring capabilities, combined with scientific advances in exercise physiology and increased awareness of the importance of the integrative exercise response in clinical assessment (1–5). Furthermore, resting pulmonary and cardiac function testing

cannot reliably predict exercise performance and functional capacity (see Section II: INDICATIONS FOR CARDIOPULMONARY EXERCISE TESTING). To achieve optimal use of this modality in clinical practice, clarification of conceptual issues and standardization of CPET practices are necessary (6).

Purpose and Scope

The purpose of this joint ATS/ACCP statement is to provide a comprehensive, conceptually balanced, reader-friendly, and practical document about CPET, which formulates guidelines and recommendations to facilitate interpretation and clinical application on the basis of current best scientific knowledge and technical advances. The focus is on clinical indications, standardization issues, and interpretative strategies for CPET in adults, with an emphasis on respiratory diseases. The scope of issues includes (1) indications; (2) methodology—equipment, modality, protocols, conduct of the test, monitoring, safety, and personnel issues; (3) measurements and graphic interrelationships and the physiologic response to exercise of “normal” subjects, and the consequences of pathophysiologic derangements on exercise performance (see Section VIII: INTERPRETATION); (4) normal reference values; (5) interpretation, including case study analysis; and (6) future recommendations for research. This document's intended audience includes those who perform clinical CPET and those who use these results to assist in the clinical decision-making process.

Guidelines established by allied health professional organizations for standard exercise testing have been appropriately applied, modified, and adopted for use during CPET (7–15). ATS guidelines/statements/position papers/procedure manuals were likewise utilized (16–25). Conventional pulmonary terms and abbreviations are presented in accordance with the ACCP/ATS Joint Committee on Pulmonary Nomenclature recommendations (26). Definitions and abbreviations appear below (see Section X: GLOSSARY).

The Joint ATS/ACCP Ad Hoc Committee on Cardiopulmonary Exercise Testing included an international group of acknowledged experts with a broad range of clinical and research expertise and conceptual orientations. Additional subspecialty expertise and allied health professional input were liberally sought. A comprehensive literature search using Medline from 1970 through 2002 and relevant publications selected by the committee members were used. In this statement, recommendations are based on best available evidence, current prevailing scientific knowledge, and expert opinion. The committee attempted to identify areas of controversy and to note clearly those areas where recommendations did not achieve clear consensus and where alternative approaches were possible.

II. INDICATIONS FOR CARDIOPULMONARY EXERCISE TESTING

Comprehensive CPET is useful in a wide spectrum of clinical settings (Table 1) (27). Its impact can be appreciated in all phases of clinical decision making including diagnosis, assessment of severity, disease progression, prognosis, and response to treatment. In practice, CPET is considered when specific questions persist after consideration of basic clinical data, including history, physical examination, chest X-ray, pulmonary function tests (PFTs), and resting electrocardiogram (ECG). A discussion of the most common indications follows.

1. Evaluation of Exercise Intolerance

Resting pulmonary and cardiac function testing cannot reliably predict exercise performance and functional capacity ($\dot{V}O_{2peak}$) in the individual subject with cardiopulmonary disease (3, 5, 27–40). Furthermore, exertional symptoms correlate poorly with

resting cardiopulmonary measurements (4, 35, 37). Although exertional dyspnea is a common symptom in patients with respiratory disease, symptoms that limit exercise often include leg discomfort, chest pain, or fatigue rather than dyspnea (4, 5). The practical relevance of CPET is further highlighted by the finding that subjective measures of a patient's quality of life reveal a stronger correlation with exercise tolerance than with either spirometry or oxygenation (41).

As such, the weight of evidence suggests that the global assessment provided by comprehensive CPET in the evaluation of exercise intolerance permits a unique and objective determination of functional capacity and impairment, quantification of factors limiting exercise, definition of the underlying pathophysiologic mechanisms such as the contribution of respiratory versus cardiac etiology in the setting of coexisting illness, timely detection of early (occult) disease (e.g., ischemia), and objective assessment of performance indices and exertional symptoms for monitoring of disease progression and response to treatment(s) (1, 2, 12, 36, 42–45).

The 6-minute walk test (6MWT) has gained popularity. Currently, both the 6MWT and CPET are used for functional assessment. Whether a 6MWT and/or CPET should be used depends on the questions being asked and the available resources; both provide complementary, albeit different, information. As such, the 6MWT will likely not replace CPET in those circumstances in which important information not available from 6MWT results is required for clinical decision making (*see* Section II,3: EVALUATION

OF PATIENTS WITH CARDIOVASCULAR DISEASE, Section II,4: EVALUATION OF PATIENTS WITH RESPIRATORY DISEASE, Section II,5: PREOPERATIVE EVALUATION, Section II,6: EXERCISE PRESCRIPTION FOR PULMONARY REHABILITATION, and Section II,7: EVALUATION OF IMPAIRMENT/DISABILITY). An ATS statement on the 6MWT has been published (46).

2. Unexplained Dyspnea

For patients with unexplained dyspnea and for whom initial test results are nondiagnostic, the weight of evidence suggests that CPET is a useful tool in identifying the following: cardiac and/or pulmonary causes (12, 27, 47–51), mitochondrial myopathy (e.g., ragged red fiber disease and McArdle's syndrome) (52–55), and psychological factors (hyperventilation, panic, anxiety syndromes, etc.) or deconditioning (47–49, 56). Results from CPET may efficiently direct further diagnostic testing to target the suspected organ system involved. Moreover, normal CPET results provide reassurance to the patient and limit subsequent testing. Diagnostic approaches or pathways that utilize CPET for the evaluation of unexplained dyspnea require further investigation (49, 51, 57, 58).

3. Evaluation of Patients with Cardiovascular Disease

Strong evidence exists to support the value of CPET in the assessment of exercise capacity and response to therapy of patients with heart failure who are being considered for heart transplantation (12, 59, 60). More recent work has confirmed

TABLE 1. INDICATIONS FOR CARDIOPULMONARY EXERCISE TESTING

Evaluation of exercise tolerance

- Determination of functional impairment or capacity (peak $\dot{V}O_2$)
- Determination of exercise-limiting factors and pathophysiologic mechanisms

Evaluation of undiagnosed exercise intolerance

- Assessing contribution of cardiac and pulmonary etiology in coexisting disease
- Symptoms disproportionate to resting pulmonary and cardiac tests
- Unexplained dyspnea when initial cardiopulmonary testing is nondiagnostic

Evaluation of patients with cardiovascular disease

- Functional evaluation and prognosis in patients with heart failure
- Selection for cardiac transplantation
- Exercise prescription and monitoring response to exercise training for cardiac rehabilitation (special circumstances; i.e., pacemakers)

Evaluation of patients with respiratory disease

- Functional impairment assessment (*see* specific clinical applications)
- Chronic obstructive pulmonary disease
 - Establishing exercise limitation(s) and assessing other potential contributing factors, especially occult heart disease (ischemia)
 - Determination of magnitude of hypoxemia and for O_2 prescription
 - When objective determination of therapeutic intervention is necessary and not adequately addressed by standard pulmonary function testing
- Interstitial lung diseases
 - Detection of early (occult) gas exchange abnormalities
 - Overall assessment/monitoring of pulmonary gas exchange
 - Determination of magnitude of hypoxemia and for O_2 prescription
 - Determination of potential exercise-limiting factors
 - Documentation of therapeutic response to potentially toxic therapy
- Pulmonary vascular disease (careful risk–benefit analysis required)
- Cystic fibrosis
- Exercise-induced bronchospasm

Specific clinical applications

- Preoperative evaluation
 - Lung resectional surgery
 - Elderly patients undergoing major abdominal surgery
 - Lung volume resectional surgery for emphysema (currently investigational)
- Exercise evaluation and prescription for pulmonary rehabilitation
- Evaluation for impairment–disability
- Evaluation for lung, heart–lung transplantation

Definition of abbreviation: $\dot{V}O_2$ = oxygen consumption.

Adapted by permission from Reference 27.

the prognostic value of CPET for patients with ischemic and dilated cardiomyopathies (44). In one study, $\dot{V}O_2\text{max} < 50\%$ predicted was the most significant predictor of cardiac death in multivariate analysis (44). In a large retrospective study, peak $\dot{V}O_2$ outperformed all other clinical, exercise, and hemodynamic data in determining risk of death among patients with severe heart failure (61); these authors suggest that all patients being evaluated for heart failure should undergo CPET (61). Another study has reported that abnormally high minute ventilation for a given level of metabolism (high slope of $\dot{V}_E\text{-}\dot{V}CO_2$ relationship), was found to be an independent prognostic marker in patients with severe heart failure (62). The predictive value of $\dot{V}O_2$ and other measurements may be increased when assessed after optimization of therapy (63).

Although well appreciated as being useful in monitoring physiologic improvement in patients with heart failure undergoing exercise training for cardiac rehabilitation (64–67), the routine use of CPET in this setting requires additional study (12, 68). Special circumstances (e.g., fixed rate pacemakers) may define when CPET is necessary for exercise training prescription before cardiac rehabilitation (12). Likewise, although CPET has been used to demonstrate the value of early exercise training after heart transplantation on quality of life and increased capacity for physical work, its routine use in this setting also remains uncertain and requires additional investigation (69). Finally, a clinical commentary concerning patients with heart failure has noted that although 6-minute walk distance correlates generally with outcome (70) and is easier to perform, it is “not precise enough” for indications including the measurement of important risk stratification determinants ($\dot{V}O_2$), for adjusting exercise prescriptions, and for gauging ability to perform physical work (63).

4. Evaluation of Patients with Respiratory Disease

4.1. Chronic obstructive pulmonary disease. CPET is clinically useful in the evaluation of patients with chronic obstructive pulmonary disease (COPD); when an objective determination of exercise capacity ($\dot{V}O_2\text{peak}$) is necessary (*see below*) in establishing exercise limitations (71–74) and assessing other factors that may be contributing to exercise limitation (occult myocardial ischemia); in relating symptoms to exercise limitation (4, 5, 75, 76), especially when exertional symptoms are disproportionate to resting PFTs (5); and when hypoxemia may contribute to exercise limitation and O_2 requirements may be directly quantified (1, 3, 28, 42, 72, 77, 78).

Furthermore, CPET permits evaluation of the impact of therapeutic interventions on overall exercise capacity and components of the exercise response, especially as it relates to breathing strategies (45, 75), relief of dyspnea, and improvement in exercise tolerance (45, 72, 79). The efficacy of CPET in monitoring a variety of treatment modalities (continuous positive airway pressure, bronchodilators, exercise training, lung volume reduction surgery [LVRS], etc.) directed at improving breathing strategy and/or reducing dynamic hyperinflation (resulting in improved breathlessness and exercise capacity) has been demonstrated (21, 45, 75, 79–87) (*see below*). An endurance constant work exercise protocol (*see* Section III.3.3: CONSTANT WORK RATE PROTOCOL) was more sensitive than the 6MWT in detecting the effects of therapeutic interventions (inhaled anticholinergic agents) on exercise performance in patients with COPD (88).

Using CPET in patients with COPD, studies have demonstrated that early onset metabolic acidosis is associated with skeletal muscle dysfunction (89) and that exercise alters amino acid metabolism including alterations in muscle oxidative capacity and exercise-related substrate levels, especially glutamate (90, 91).

4.2. Interstitial lung disease. CPET is efficacious in the early

detection of subtle pulmonary gas exchange abnormalities not revealed by routine testing. This is important in establishing a timely diagnosis and accurate physiologic severity assessment, as well as in permitting the monitoring of therapeutic interventions (29, 31, 92–99). Whether CPET, in particular exercise pulmonary gas exchange, has prognostic value for interstitial lung disease (IPF) is controversial and requires additional investigation (100, 101).

4.3. Chronic pulmonary vascular disease. In chronic pulmonary vascular disease the maximal oxygen consumption ($\dot{V}O_2\text{max}$) provides an index of severity, being lower in patients with high pulmonary vascular resistance and lower cardiac index as well as being significantly correlated with the amount of functional vascular bed (102–104). More recent work in patients with primary pulmonary hypertension has confirmed that reductions in $\dot{V}O_2\text{peak}$ reflect reduced cardiac output (105) and functional capacity and that CPET and 6-minute walk tests provide complementary information in the evaluation of these patients (106). The presence of a patent foramen ovale and right-to-left shunting can also be diagnosed with the assistance of CPET while the patient respire 100% O_2 . Because of significant mortality risk, exercise testing should be approached cautiously, especially in patients with primary pulmonary hypertension; if syncope, arrhythmia, and/or acute right heart failure is evident, exercise testing should not be performed (107). However, CPET can be performed safely in patients with primary pulmonary hypertension (105). Resting hemodynamic data correlate well with exercise results and may suffice in monitoring response to treatment (103, 108). Indications for CPET in the individual patient must reflect careful risk-benefit analysis.

4.4. Cystic fibrosis. Work has provided convincing evidence that the measurement of $\dot{V}O_2\text{peak}$ is valuable for prognosis and management of patients with cystic fibrosis (109). More recent work suggests that CPET results and estimates of muscle size (cross-sectional area) may provide an optimized exercise prescription for patients with cystic fibrosis (110).

4.5. Exercise-induced bronchospasm. CPET is useful in diagnosing suspected exercise-induced bronchospasm, especially when standard protocols and practices are modified to optimize conditions conducive for eliciting symptoms and monitoring responses (serial spirometry before and after exercise) (24, 111–113). A negative test, however, does not preclude the diagnosis of exercise-induced bronchospasm. Functional evaluation (CPET) of patients with asthma may be a useful tool for encouraging increased physical activity and for optimizing exercise prescription (114).

5. Preoperative Evaluation

5.1. Preoperative evaluation for lung cancer resectional surgery.

Whereas routine pulmonary function tests (FEV_1 , diffusing capacity of the lung for CO [DL_{CO}]) have the greatest utility in documenting physiologic operability in low-risk patients, other diagnostic modalities, including CPET and/or split function assessment by quantitative lung scintigraphy, is/are often necessary to more accurately assess moderate- to high-risk patients (20, 115, 116). Although there are proponents for both approaches (117–120), work suggests that CPET and the measurement of $\dot{V}O_2\text{peak}$ (especially when expressed as a percentage of the predicted value) appear to be particularly useful in predicting postoperative pulmonary complications (121–123). A $\dot{V}O_2\text{peak}$ less than 50–60% predicted is associated with higher morbidity and mortality after lung resection (121–123).

Preoperative CPET and split function study results may be used in tandem to predict the risk of postoperative pulmonary complications and functional capacity; this may be most beneficial to “borderline” patients who might otherwise be precluded

from surgery (124–127). In addition, CPET permits the detection of clinically occult heart disease and provides a more reliable estimate of functional capacity postoperatively compared with PFTs, which routinely overestimate functional loss after lung resection (122). Prospective validation of an algorithm for the functional assessment of lung resection patients has demonstrated that morbidity and mortality were reduced by one-half without unnecessarily excluding patients from surgery (128). These algorithms have proved highly sensitive for excluding morbidity from conventional surgery, although in the context of a potentially life-saving cancer operation patients and physicians may decide to incur a somewhat greater risk than the algorithm allows. Furthermore, different surgical approaches and advances in less invasive surgical techniques and postoperative care may result in interinstitutional differences in risk. Continued prospective validation of algorithms for preoperative functional assessment for lung resection surgery is necessary.

5.2. Lung volume reduction surgery. The potential utility of CPET is highlighted by its emergence as an important tool in the evaluation of emphysema patients being considered for LVRS. The range of application of CPET in this patient group includes the determination of cardiopulmonary functional status and assessment of potential operative risk before surgery, the determination of exercise training prescription before and after LVRS, the quantification and monitoring of the clinical response to surgery, and also the definition of underlying pathophysiologic mechanisms responsible for improvements in exercise performance resulting from LVRS.

As LVRS continues to be actively investigated, an expanding CPET database from several studies has yielded improvements in the quantification of many clinically relevant exercise performance variables after LVRS, which may not be revealed in standard pulmonary function studies (81, 129–135). Significant improvement in right ventricular performance, particularly during exercise, has been reported at 6 months after bilateral LVRS (136). LVRS remains controversial largely because of uncertainties with respect to patient selection and long-term outcome (137). The National Institutes of Health-sponsored multicenter National Emphysema Treatment Trial, evaluating the efficacy of LVRS, has chosen the maximal work rate derived from CPET as its primary physiologic outcome parameter, because it was considered to be the best objective measure of functional status.

5.3. Evaluation for lung or heart–lung transplantation. With the emergence of lung and heart–lung transplantation for patients with end-stage pulmonary vascular and parenchymal lung disease as a viable therapeutic option, comprehensive CPET is increasingly being used to evaluate these complex patients before and after transplantation. As such, CPET is useful in assessing disease progression before transplantation, and in assessing functional capacity, quantitating causes of exercise limitation, and providing exercise prescription for pulmonary rehabilitation before and after transplantation (138, 139). However, there is presently no consensus on how indices of exercise performance may impact the clinical decision-making process for lung transplantation selection. As previously noted, selection guidelines for cardiac transplantation based on exercise performance ($\dot{V}O_2\text{max}$) have been established (12, 44, 59).

From a clinical perspective, integrative CPET results in the transplantation arena have reinforced the importance of the multifactorial etiology of exercise limitation and that of skeletal muscle dysfunction in patients with heart disease (140, 141) and chronic lung disease (1, 138, 139, 142–147). Furthermore, although a 6MWT distance of less than 400 m is useful in listing for lung transplantation (148), the information provided is imprecise in answering important questions related to patient management. Pretransplantation CPET results demonstrate severe

exercise intolerance related to ventilatory and/or circulatory limitation. Despite significant improvement in quality of life, PFTs, and hemodynamics with transplantation, considerable exercise limitation persists ($\dot{V}O_2$ approximately 45–55% predicted) and is remarkably similar for single-lung, double-lung, or heart–lung transplantation (138, 139, 145, 147). Cardiac and ventilatory factors are usually not limiting, although abnormal breathing patterns have been observed (145, 149–151). In turn, peripheral factors (peripheral circulation and/or peripheral muscle), especially skeletal muscle dysfunction, are purportedly primarily responsible (144, 146, 147). However, as noted, exercise limitation is most probably multifactorial.

5.4. Preoperative evaluation for other procedures. Work has shown that CPET is helpful in objectively assessing the adequacy of cardiovascular reserve and in predicting cardiovascular risk in an elderly population (152).

6. Exercise Prescription for Pulmonary Rehabilitation

Exercise training is a recommended, integral component of comprehensive pulmonary rehabilitation in patients with COPD and other chronic lung diseases (22, 153). CPET provides valuable information before exercise training to determine safety and to optimize training intensity (38, 154, 155) and can be repeated after training to objectively document improvement and to refine training levels. This is preferably achieved with CPET, compared with a standard or treadmill 6MWT (46, 63, 156).

Objective assessment of performance capacity as well as identification of arrhythmia, arterial desaturation, and the presence and timing of lactic acidosis can be obtained by CPET.

An increasing number of studies have used CPET to document improvement in exercise tolerance and $\dot{V}O_{2\text{peak}}$ (153, 157), reduced ventilatory requirements (155, 158), and improved muscle oxidative capacity (159) resulting from exercise training in COPD. Work has documented that a physiologic training effect can be accomplished in severe COPD (160, 161) and even without achieving lactic acidosis. Although improved ventilatory efficiency has been suggested as the primary mechanism (161), more recent work using CPET and ^{31}P magnetic resonance spectroscopy has alternatively emphasized the improvement in skeletal muscle bioenergetics (162). Provocative work has reported that a training-induced reduction in skeletal muscle redox status occurs in patients with COPD versus control subjects, highlighting the importance of training-induced peripheral adaptations and their relevance to the assessment of training outcomes in patients with COPD (163, 164).

Controversy persists, however, and additional investigation is required regarding optimal training intensity/regimens for COPD (38, 153, 160, 161), including the role of combined strength and aerobic training in exercise tolerance and health-related quality of life (165, 166).

7. Evaluation of Impairment/Disability

Increasing awareness of the inadequacies of resting cardiopulmonary measurements and tests in accurately predicting functional impairment (work capacity) and exercise limitation in patients with respiratory disease has focused attention on the expanded role of CPET in the evaluation of impairment/disability (34, 167–171). CPET complements other clinical and diagnostic modalities, and by directly quantitating work capacity improves the diagnostic accuracy of impairment/disability evaluation (170–174). Whereas an earlier ATS statement concluded that CPET might be helpful only in selected cases of impairment evaluation (16), more recent work has demonstrated its enhanced diagnostic accuracy and impact on clinical decision making in cases ranging from mild–moderate impairment (32, 173, 175) to severe COPD (176).

TABLE 2. EXERCISE EQUIPMENT: CYCLE ERGOMETRY VERSUS TREADMILL

	Cycle	Treadmill
$\dot{V}O_2$ max	lower	higher
Work rate measurement	yes	no
Blood gas collection	easier	more difficult
Noise and artifacts	less	more
Safety	safer	less safe?
Weight bearing in obese	less	more
Degree of leg muscle training	less	more
More appropriate for:	patients	active normal subjects

Definition of abbreviation: $\dot{V}O_2$ max = maximal oxygen uptake.

CPET may be particularly helpful when job-related or exertional complaints are disproportionate to measured PFT impairments (170, 171); when concurrent conditions (heart disease) or other factors (smoking) may limit exercise (32, 170–172, 175); and when used in combination with job-related energy (177) and environmental conditions, so that an accurate rating of impairment/disability can be established (170). An updated comprehensive framework for impairment/disability evaluation is urgently needed.

III. METHODOLOGY

1. Equipment and Methodology

The goal of cardiopulmonary exercise testing is to evaluate the organs and systems involved in the exercise response, under conditions of progressively intense physical stress. Therefore, exercise testing involves large muscle groups, usually the lower extremity muscles as in running on the treadmill or pedaling on a cycle ergometer. It is usually most efficient to employ a progressively increasing work rate protocol so that a range of exercise intensities can be studied in a short period of time. Technologic advances (*see below*) have made it possible for a sufficient density of data to be acquired and displayed online in an appropriately designed test lasting less than 20 minutes from start to finish (rest, unloaded, incremental exercise).

1.1. Exercise equipment. Two modes of exercise are commonly employed in cardiopulmonary exercise tests: treadmill and cycle ergometer (Table 2). The motor-driven treadmill imposes progressively increasing exercise stress through a combination of speed and grade (elevation) increases. Several incremental protocols are popular and the choice among them depends on the objectives of the test and the degree of the patient's debilitation (178–183). Treadmill exercise testing has several advantages over cycle ergometry. For most individuals, treadmill walking is a more familiar activity than cycling. Walking on the treadmill, however, is more complex than ordinary walking, as evidenced by differences in 6MWT distance results among subjects performing on a treadmill versus walking (156). That fact

notwithstanding, walking/running permits a larger muscle mass to be brought to bear during maximal treadmill exercise and more work against gravity is done, leading to greater stress on the organ systems mediating the exercise response. Consequently, on average, maximal oxygen uptake is reported to be 5–10% higher on a treadmill than on a cycle ergometer (184–187). This may be important for athletes, in whom the determination of $\dot{V}O_2$ max is critical, and in some patients in whom abnormalities (e.g., cardiac ischemia) may occur only with the highest metabolic demand. If exercise testing is being used to provide a prescription for subsequent exercise training, then it may be advantageous to use the same exercise modality in testing as for training.

The main disadvantage of treadmill exercise testing is that it is difficult to accurately quantify the external work rate of the subject during treadmill exercise. The relationship between speed and grade of the treadmill and the metabolic cost ($\dot{V}O_2$) of performing work is only an estimate, and therefore it is difficult to predict $\dot{V}O_2$ from treadmill testing (12). The weight of the subject and pacing strategy are important determinants in this regard. Body weight has much less effect on bicycle ergometer performance. Holding onto the treadmill handrails can alter (usually decreases) the metabolic cost of treadmill walking and should be discouraged whenever possible.

The cycle ergometer is generally less expensive and requires less space than the treadmill. It is also less prone to introduce movement or noise artifacts into measurements (e.g., ECG and blood pressure auscultation are generally easier). The principal advantage, however, is that the rate at which external work is performed is easily quantitated. There is a modestly greater metabolic requirement for moving heavier legs in obese individuals (3, 188–190), about 5.8 ml/minute per kilogram body weight (190); but as long as the pedaling cadence is kept constant, this represents a constant offset. The predictability of the relationship between work rate and metabolic energy expenditure is important for diagnosis (*see SECTION IV,1.1: $\dot{V}O_2$ –WORK RATE RELATIONSHIP*).

There are two types of cycle ergometers. Mechanically braked cycles regulate external work by adjustable frictional bands. Electrically braked cycles increase resistance to pedaling electromagnetically. Friction-braked cycle ergometers (191) generally do not offer sufficiently precise work rate settings and also require the subject to pedal at a fixed cadence to keep the work rate constant for a given setting of the bands. In contrast, the electrically braked cycle ergometer (192) allows direct quantification of the work rate performed and can be computer controlled; this allows the work rate to be incremented automatically and even continuously (e.g., “ramp pattern”) (193–200). This type of ergometer is often constructed so that moderate changes in pedaling rate (40 to 70 rpm) do not influence the work rate performed. Cycle ergometers have become available that allow true unloaded pedaling (199, 200). The internal resistance of the ergometer is overcome by means of a motor “assist,” so that

TABLE 3. COMPARISON OF FLOW AND VOLUME MEASUREMENT DEVICES

	Pneumotachograph	Hot Wire Anemometer	Pitot Tube Flow Meter	Turbine Volume Transducer
Saliva impact	Saliva changes screen resistance	Saliva changes hot wire conductivity	Calibration is relatively unaffected because of multiple side holes	Saliva impacts on rotor, changing inertance
Cleaning: level of difficulty	Moderate	Moderate	(Disposable)	Moderate
Gas viscosity	Changes calibration	Independent	Changes calibration	Independent
Gas density	Changes calibration	Independent	Changes calibration	Independent
Water vapor	Condensation changes resistance	Condensation changes heat conductivity of wires	Relatively unaffected	Condensation can alter mass of rotor

TABLE 4. ANALYZER STANDARDS FOR GAS CONCENTRATION MEASUREMENTS

	Bag Collection	Mixing Chamber	Breath-by-Breath Mode
Delay time, s	< 30	< 0.5	< 0.5
Rise time, s	< 5	< 0.5	< 0.1
Water vapor	If the analyzer calibration is affected, gases must be dried before measurement	If the analyzer calibration is affected, a drying agent must be used in the sample line	Either use an analyzer that is unaffected, or dry the gas in the sample line
Calibration stability	± 3% of the signal over 5 min	± 3% over 20 min	± 3% over 20 min
Calibration linearity	± 3% of the signal over full range	± 3% over full range	± 3% over full range
Sample rate	No requirement, but must be measurable	If significant, zero the flow meter with the sample pump on	If significant, zero the flow meter with the sample pump on

patients do not have to pedal against flywheel inertia as exercise begins; this is especially important for the most debilitated patients.

On occasion, some patients are unable to perform lower extremity exercise. For such patients, arm crank ergometers can be adapted for incremental exercise testing. However, the metabolic stress that can be induced during arm cranking is limited; in healthy subjects peak $\dot{V}O_2$ averages roughly 70% of that achievable during lower extremity exercise (201–204) and lactic acidosis is often evident at low work rates (201). It should be noted that patients with lung disease tolerate arm cranking poorly; arm cranking interferes with the use of the accessory muscles of respiration.

Recommendation: In most clinical circumstances, cycle ergometry is the preferable mode of exercise; however, depending on the reason(s) for which CPET was requested and equipment availability, a treadmill may be an acceptable alternative.

1.2. Airflow or volume transducers. A number of flow-transducing devices have been adapted for exercise testing. The choice of a flow versus a volume transducer is no longer crucial because numeric integration or differentiation can be employed to calculate one entity from knowledge of the other. Digital computer processing can accommodate a nonlinear relationship between a flow or volume and transducer output. Transducers used for exercise testing must be lightweight, have low dead space, and low resistance to flow in the range of flows encountered during exercise and be immune to effects of water vapor or pools of saliva that may accumulate during testing. A key consideration is whether the transducer can be positioned near the mouth. Such transducers are capable of sensing flow or volume bidirectionally. They also eliminate the need for a nonbreathing valve and this reduces the system dead space. All transducers listed below, with the exception of the pneumotachograph, can be used in a bidirectional configuration. Accurate values for ventilation and metabolic parameters obtained from exercise testing are critically dependent on the accuracy of the flow-sensing device. For this reason, accurate calibration is essential, and software must provide easy methods for either changing calibration factors or verifying the accuracy of current calibration before each test.

The ATS has established standards for flow and volume measurement in the context of spirometry (19). The transducers used in exercise testing should also meet these standards (25).

Transducers currently employed for measuring flow or volume in cardiopulmonary exercise testing are listed in the following sections. A summary of the major advantages and disadvantages of each is given in Table 3.

1.2.1. Pneumotachograph. This flow transducer measures the pressure drop across a low-resistance screen (189, 205–207). Because laminar flow is required and sputum impaction on the transducer screen can degrade performance, pneumotachographs have generally been positioned well downstream from the mouth. They are often heated to prevent condensation of water vapor within the screen.

1.2.2. Mass flow sensor. This device is related to the older hot wire anemometer, in which the current required to heat a wire placed in the air stream to a certain temperature increases as airflow increases (208, 209). In one configuration presently used, two wires heated to different temperatures are utilized; flow detection depends on the fact that the hotter wire loses heat more rapidly than does the cooler wire. The signal generated is (nonlinearly) proportional to the number of molecules passing the sensor rather than the volume of gas these molecules occupy.

1.2.3. Pitot tube flow meter. This device determines the difference in pressure between orifices facing the flow stream and orifices perpendicular to or facing away from the flow stream. Turbulent (rather than laminar) airflow is involved and the pressure difference is proportional to the square of the flow rate (210, 211). Linearization of output is usually handled digitally within a microprocessor.

1.2.4. Turbine volume transducer. A lightweight impeller is placed in the flow stream and the number of interruptions of a light beam are counted by a computerized system (207). Although small, the mass of the impeller causes the impeller speed to lag behind changes in flow rate (i.e., dynamic nonlinearities), which can lead to errors in timing of the start and end of the breath (212). However, technological advances have been made in the design of this type of sensor, so newer models may be less impacted by such effects.

Recommendation: Automated exercise systems may use any of the above-described technologies for sensing flow and volume, provided that manufacturers supply complete specifications for resolution, linearity, and calibration stability of the sensors. The devices should at minimum comply with the same and most current standards established by the American Thoracic Society for spirometers.

1.3. Gas analyzers. Suggested standards for gas analyzer performance in different modes of metabolic rate measurement are listed in Table 4. Two types of gas analyzers can be used: a mass spectrometer (considered the “gold” standard), which is capable of measuring all the required respiratory gases (CO_2 , O_2 and, for some purposes, N_2), and separate analyzers for O_2 and CO_2 .

The dynamics of analyzer response have two separable components: transport delay (the time required for gas to traverse the distance from the sampling site to the analyzer) and analyzer response (the kinetics of response to a change in gas composition introduced into the analyzer). Computer software allows compensation for gas transport delay, generally on the order of 0.2 to 0.4 second, depending on the length of the gas-sampling tube and the gas-sampling rate. The analyzer response, often taking the form of a sigmoid or exponential response to a stepwise change in gas composition, is extremely difficult to fully compensate (213, 214); the time constant of this exponential response must be kept as short as possible. An additional concern is sensitivity of the analyzer to water vapor partial pressure in the sampled gas. Because water vapor partial pressure in the sampled gas can be difficult to predict (principally because the gas temper-

ature is difficult to predict), this can introduce substantial errors in metabolic rate calculations (*see* Beaver [215] for discussion). Some analyzers require gas to be physically dried before it reaches the analyzer.

The mass spectrometer ionizes gas molecules in a high-vacuum environment and then separates them on the basis of mass-to-charge ratio. This enables the measurement of a number of gases. These analyzers are linear, often highly stable, and have rapid response characteristics (analyzer half-times of response of roughly 25–50 milliseconds). They are configured to “ignore” water vapor, yielding “dry gas fractions.” However, the high cost of mass spectrometers has inhibited their use in most commercial cardiopulmonary exercise systems.

Discrete O₂ and CO₂ analyzers have been modified specifically for the demands of cardiopulmonary exercise testing. Carbon dioxide analyzers, based on absorption of infrared light by CO₂ (216), are common. Oxygen analyzers based on two principles have been employed. In paramagnetic analyzers, the effect of oxygen molecules on a magnetic field is utilized. In the electrochemical (“fuel cell”) analyzer, high-temperature reactions between O₂ and substrate are measured. These analyzers have potential disadvantages. The analyzer output is usually not a linear function of gas concentration; however, computerized correction can be made for these nonlinearities. The sensitivity of these analyzers to water vapor content has been circumvented by using sampling tubing (polymer Nafion) that absorbs water. The gas that reaches the analyzer therefore contains little water vapor. Failure of the drying process can be a source of errors in measurement of \dot{V}_{O_2} and \dot{V}_{CO_2} .

1.4. Gas exchange measurement: \dot{V}_{O_2} and \dot{V}_{CO_2} . Conceptually, oxygen uptake (\dot{V}_{O_2}) and carbon dioxide output (\dot{V}_{CO_2}) each represent the difference between the volume of gas (O₂ and CO₂, respectively) inhaled and the volume exhaled per unit of time. Under steady state conditions \dot{V}_{O_2} and \dot{V}_{CO_2} will be equal to the rate of metabolic O₂ consumption and CO₂ production. The measurement of \dot{V}_{O_2} is based on the mass balance equation:

$$\dot{V}_{O_2} = (\dot{V}_I \times F_{I_{O_2}}) - (\dot{V}_E \times F_{E_{O_2}})$$

\dot{V}_I and \dot{V}_E represent the volumes of inhaled and exhaled gas, respectively. $F_{I_{O_2}}$ and $F_{E_{O_2}}$ represent the O₂ concentration in the inhaled and “mixed” exhaled gas, respectively. \dot{V}_I , however, is not commonly measured; rather, it is calculated from \dot{V}_E on the assumption that the virtually insoluble gas N₂ is neither absorbed into nor discharged from the capillary blood:

$$\dot{V}_I \times F_{I_{N_2}} = \dot{V}_E \times F_{E_{N_2}}$$

$$\dot{V}_I = \dot{V}_E \times F_{E_{N_2}}/F_{I_{N_2}}$$

The measurement of \dot{V}_{CO_2} is simpler, because $F_{I_{CO_2}}$ in room air is practically zero and may be safely ignored in the calculation:

$$\dot{V}_{CO_2} = \dot{V}_E \times F_{E_{CO_2}}$$

1.4.1. Bag collection method: Douglas bag. Bag collection is considered the gold standard for determining \dot{V}_{O_2} and \dot{V}_{CO_2} , as it can be performed with simple and basic equipment, requiring only the measurement of large gas volumes and accurate measurement of gas concentrations without the need for rapidly responding gas analyzers. However, it is not without technical difficulties and inaccurate results can be obtained. The basic technique involves collecting the expired air (by use of a two-way nonbreathing valve) into a collection bag. A timed collection is made; the concentrations of CO₂ and O₂ in the bag and the volume of gas in the bag are subsequently measured; this allows calculation of \dot{V}_{O_2} and \dot{V}_{CO_2} (43, 215, 217). \dot{V}_{CO_2} and \dot{V}_{O_2} are

expressed at STPD whereas \dot{V}_E is expressed under BTPS conditions. A Tissot spirometer or a dry gas meter is used to measure the collected gas volume. Use of highly accurate and well-calibrated gas analyzers is essential for measurement of expired gas concentrations. The gold standard for gas analysis is the traditional differential chemical absorption technique; however, few laboratories are capable of performing Scholander or Haldane analysis (218). The mass spectrometer has emerged as the current gold standard measurement modality, even though it is not widely available and is not routinely used in automated systems. The bag collection method is capable of precise measurements even at high metabolic rates (217). Technical problems could arise as a result of leakage from the nonbreathing valve and also because of short collection times (less than 1 minute), which may reduce the signal-to-noise ratio. This method is usually performed under steady state conditions (constant work rate) and becomes more cumbersome when performed during incremental exercise protocols at high work rates.

1.4.2. Mixing chamber. Mixed expired gas concentrations for use in gas exchange measurements can also be estimated with a gas-mixing chamber. Automated systems featuring a mixing chamber have computer interfaces that allow continuous measurement of \dot{V}_{O_2} and \dot{V}_{CO_2} (3, 42, 219, 220). Typically, the subject breathes through a two-way valve and expired air is directed through a baffled chamber (usually 5- to 15-L capacity) in which the baffles facilitate mixing of the entering gas. The concentrations of CO₂ and O₂ are measured continuously at the distal end of the mixing chamber and averaged every 15–20 seconds. Expired volume is also measured continuously with any of the flow devices previously described (pneumotachometer, anemometer, turbine, etc.) and also usually averaged every 15–20 seconds. The averaged concentrations of expired gas and the corresponding expired volume data are then used to calculate \dot{V}_{O_2} and \dot{V}_{CO_2} . For the final report, the data should be averaged over 30–60 seconds.

During steady state exercise, mixing chamber systems are capable of accurate metabolic rate measurements. However, because the washout of the mixing chamber requires a finite time (which depends on the level of exhaled ventilation and the geometry of the chamber), the volume and gas concentration signals may be “misaligned” in the unsteady state, leading to inaccurate calculations. However, for incremental protocols commonly used for clinical CPET, ventilation and mixed expired gas concentrations do not change rapidly and, therefore, the accuracy and precision of a well-designed mixing chamber may be comparable to those of the breath-by-breath systems (221). The disadvantages of using a mixing chamber include inability to assess end-tidal variables (end-tidal partial pressure of oxygen [$P_{ET_{O_2}}$] and end-tidal partial pressure of carbon dioxide [$P_{ET_{CO_2}}$]) simultaneously; also, gas exchange kinetics are more difficult to characterize (222). Currently, several commercially available systems use this method for gas exchange determination.

1.4.3. Breath-by-breath mode. With the ready availability of online digital computer analysis of physiologic measurements (Figure 1), it has become practical to compute \dot{V}_{CO_2} and \dot{V}_{O_2} on a breath-by-breath basis (223, 224). Utilizing algorithms first reported in 1973 (223), a signal proportional to expired airflow and signals proportional to fractional concentrations of CO₂ and O₂ measured near the mouth are typically sampled 50 or 100 times per second. In this way, each breath is broken down into a large number of parts and the O₂ uptake and CO₂ output are calculated for each interval (Figure 2). These measurements are summed over the entire expiration to compute the total volume of O₂ uptake and CO₂ output per breath, V_{O_2} and V_{CO_2} , respectively. The values of each breath are extrapolated to the minute.

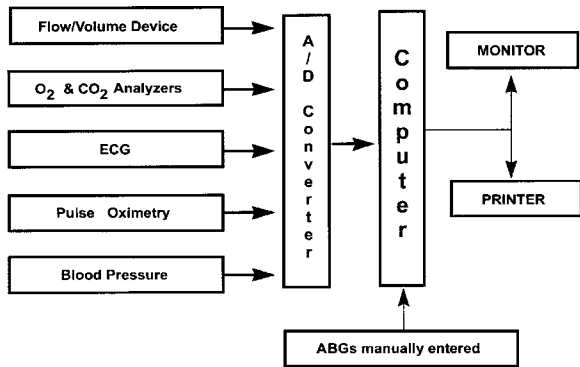

Figure 1. Diagram of the instruments and computer system used for the measurement of cardiopulmonary variables in a breath-by-breath mode (automated system). ABGs = Arterial blood gases; A/D = analog to digital; ECG = electrocardiogram.

$$\dot{V}O_2 = \Sigma (F_{I_{O_2}} - F_{E_{O_2}}) \times \dot{V}_E \times \Delta t$$

$$\dot{V}CO_2 = \Sigma F_{E_{CO_2}} \times \dot{V}_E \times \Delta t$$

where \dot{V}_E is the instantaneous expired airflow rate; Δt is the sampling interval; and $F_{I_{O_2}}$, $F_{E_{O_2}}$, and $F_{E_{CO_2}}$ are the fractional instantaneous concentrations of inspired O₂, expired O₂, and expired CO₂, respectively.

These calculations must accommodate water vapor, barometric pressure, and ambient temperature variations (*see* Beaver [215]). As importantly, compensation is necessary for the delay between the time at which gas is sampled at the mouth and the time at which the gas concentration is measured within the gas analyzers (usually on the order of 0.2–0.4 second). Breath-by-breath analysis, therefore, requires precise knowledge of gas analyzer delays and response kinetics (224).

Although breath-by-breath data collection/analysis is presently the most popular, it is important to recognize that the confidence with which these “metabolic” indicators can be calculated depends on the combined measurement errors for each of the determined variables. Unless great care is taken with the calibration of the sensors, these errors can be additive and large. A further concern is the assumptions of the algorithms (225–227). For example, breath-by-breath changes in end-expiratory lung volume (EELV) will violate the strict requirement that $\dot{V}O_2$ be measured in expired-only gas, and substantial error can be introduced with each breath in which EELV changes; however, these effects are generally damped out by averaging over time (228–230). Several factors can also introduce additional errors in the measurements. In some patients, the concentrations recorded during each expiration may not represent the composition of the average alveolar gas (i.e., in patients with COPD and other patients with inhomogeneous distribution of ventilation). Furthermore, inaccurate integration of the three signals (flow, F_{O₂}, and F_{CO₂}) can also occur in patients who do not have a uniform and smooth breathing pattern, due to circulatory oscillations, as has been reported in patients with heart failure (231).

To improve the reliability of breath-by-breath measurements, algorithms have been developed and implemented (225, 227) to enable breath-by-breath compensation for changes in lung gas stores. This allows approximation of the rate of gas transfer between the airspaces and the pulmonary capillaries.

Recommendations: Both breath-by-breath and mixing chamber data collection/analysis of CPET results can be used for clinical purposes. The convenience of the breath-by-breath methodology and the flexibility in the treatment of the data have

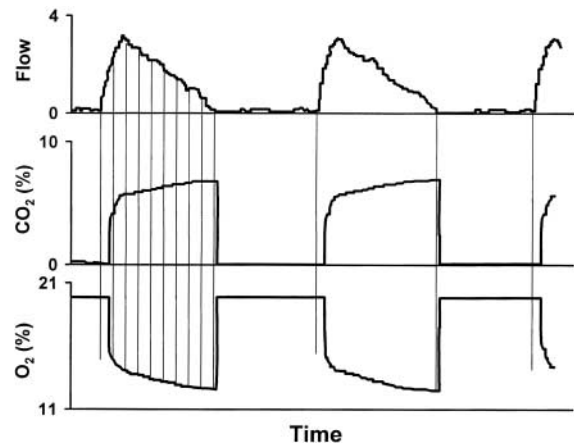

Figure 2. Scheme of the processing of the three main signals—flow, O₂ concentration (%), and CO₂ concentration (%) used for cardiopulmonary measurements. The three signals are aligned by using the transport delay and time response of the gas concentration analyzer. Each expiration is partitioned into a large number of segments (each typically 10 milliseconds in duration). \dot{V}_E , $\dot{V}O_2$ and $\dot{V}CO_2$ are measured in each segment by multiplying flow times gas concentration times Δt (*see* equations in text). The values of all the segments are added to obtain the \dot{V}_E , $\dot{V}O_2$, and $\dot{V}CO_2$ per breath. Finally, these values are extrapolated to the minute to obtain \dot{V}_E , $\dot{V}O_2$, and $\dot{V}CO_2$.

made this technique especially attractive and widely utilized. However, there is considerable potential for erroneous data. The Douglas bag method should be used for quality control of the automated systems with minimal quality assurance standards developed for use by industry.

1.4.4. Formatting of breath-by-breath results. To a large extent, the breath-by-breath fluctuations (noise) in the ventilatory and metabolic variables measured can be minimized by mathematical manipulation of the breath-by-breath responses. For graphic display and tabular report of the results, several options are available: running average of a chosen number of breaths, running median of seven breaths, running average of five of seven breaths, and average of all breaths at intervals of different duration. The results are always extrapolated to per-minute values. For the tabular report, the default option offered by commercial systems is to average the breaths at intervals of different duration, usually 30 to 60 seconds. Significant differences in results from the same test can occur as a result of time interval selection (230, 232). Differences of more than 15% in $\dot{V}O_2$ have been reported with different choices of time intervals. Variability increases as sample averaging decreases. Intervals of 30 and 60 seconds compare better with results from nonautomated systems (228, 229).

Recommendations: All the breaths collected should be used in the processing of the data. However, erroneous breaths caused by swallowing, coughing, and so on, should not be included. For the final tabular and graphic report, 30- to 60-second intervals for averaging data are recommended although 20-second intervals may be acceptable.

1.5. Electrocardiograph. Heart rate usually is measured from the R-R interval of the electrocardiogram. A key requirement is that the electrodes and the detection electronics be specially designed for movement artifact rejection. For optimal detection of myocardial ischemia and cardiac arrhythmias during exercise, serial 12-lead electrocardiograms should be monitored in most clinical exercise tests (7, 191). However, in some exercise tests, three lead electrocardiograms may be used to monitor for

TABLE 5. MINIMAL REQUIREMENTS FOR CARDIOPULMONARY EXERCISE TESTING EQUIPMENT

Equipment	Range	Accuracy*	Reproducibility (%)	Frequency Response (ms)	Test Signal
O ₂ analyzer	0–100%	1%	1	< 130	Minimal two-point calibration
CO ₂ analyzer	0–10%	1%	1	< 130	Minimal two-point calibration
Flow meter	0–14 L/s	3%	3	< 40	3-L syringe
Cycle ergometer	0–400 W	2% or 3 W above 25 W			Dynamic torque meter
Treadmill	0–10 mph	0.2 mph			Timed revolution of marker on belt
	0–20% grade	0.5%			Measurement with carpenter's ruler

* Linearity within the indicated percentage of full scale for each apparatus.

rhythm disturbances and to screen for ischemia. Computerized systems enabling continuous CRT display contribute to test safety; averaging of ECG complexes is not recommended and it should be used only as a supplement to the raw data. Skin preparation and use of sweat-resistant adhesive electrodes are important to decrease the noise on the ECG tracing. The 12-lead ECG electrodes positioning proposed by Mason and Likar (233) best resembles the standard ECG.

1.6. Noninvasive blood pressure. Auscultation of blood pressure becomes more difficult during exercise because of the increase in ambient noise and movement artifacts. Yet detection of exercise-induced hypertension (or, less commonly, hypotension) is an important goal in many circumstances (191). Automated blood pressure measurement systems have been developed specifically for use during exercise. Many operate on the oscillometric method, in which, as the cuff is automatically deflated in stages, pressure oscillations induced within the cuff by pulsations in the arm are detected (234). Despite algorithms designed to decrease the effects of artifacts, blood pressure measurements may be inaccurate when, for example, the arm is flexed during the measurement cycle. Periodic checks against manual determinations are therefore important.

1.7. Intraarterial blood pressure. For studies in which an arterial catheter is inserted to facilitate blood sampling, it may be useful to measure blood pressure directly. It should be appreciated that intraarterial blood pressure measurements are modestly higher than those produced by auscultation, particularly in systolic pressure measurements. The diastolic blood pressure does not change or slightly decreases on exercise with auscultation but slightly rises with intraarterial measurement (235, 236). Miniature transducers that can be attached to the thorax or to the arm while the subject exercises are available. Meticulous attention to technique (e.g., exclusion of air bubbles) is necessary to assure good frequency response. The transducer should be placed and “zeroed” at the left atrium level (fourth intercostal space at the midclavicular line). Presently, most laboratories employ single-use disposable blood pressure transducers.

1.8. Pulse oximetry. Pulse oximeters detect the variation in transmission of light of two different wavelengths that occur with arterial pulsations in an extremity (usually the finger or ear lobe). Because oxygenated and reduced hemoglobin transmit certain light wavelengths differently, this information is used to estimate arterial O₂ saturation (237). Although useful and convenient for continuous monitoring (238, 239), awareness of several important issues is necessary. In general, pulse oximeters have reasonable accuracy: 95% confidence limits of ± 4 –5% as compared with directly measured arterial O₂ saturation (240), provided that a good pulse signal is obtained. The measurement is thought to be less accurate at saturations below about 88% (241), which is exacerbated in black patients (242).

Some authors have reported that pulse oximeters tend to overestimate true arterial O₂ saturation (77, 243, 244). On the other hand, poor perfusion of the extremity (yielding decreased pulsatility), which may occur in cardiovascular disease, may yield falsely low readings (245). Movement and stray light can yield

artifacts. Dark skin color can interfere with signal detection (242, 246). These devices cannot detect carboxyhemoglobin or methemoglobin; the calculations approximate the oxygenated fraction of available hemoglobin. An additional disadvantage of pulse oximetry is that arterial O₂ saturation rather than Po₂ is measured. Arterial Po₂ is more relevant in assessing the effects of lung disease on pulmonary gas exchange. It should be noted that despite a fall in arterial Po₂ to 70 mm Hg, saturation would still remain above 93%, as the O₂ dissociation curve at this point is insensitive to changes in Po₂. In general, pulse oximeters are good for monitoring trending phenomenon but not reliable for determining absolute magnitude of change (247). Quality assurance for pulse oximeters should include validation with arterial oxygen saturation. Significant desaturation (i.e., a change in arterial oxygen saturation [ΔSp_{O_2}] $\geq 5\%$) should be confirmed with arterial blood gases (13, 25).

1.9. Calibration procedures/quality control. For cardiopulmonary exercise testing systems purchased as a unit, the manufacturer bears the responsibility for demonstrating that the system is accurate and precise. This should include description of the methods used in their validation. If possible, the ventilatory and gas exchange measurements of each unit should be validated by the bag collection method, with the gas concentrations analyzed by Scholander or mass spectrometry techniques. Minimal equipment requirements are presented in Table 5. Ideally, independent reference laboratories would validate CPET systems akin to the process available for spirometers.

However, it must be stressed that the user bears the responsibility for assuring that measurements remain accurate. Cardiopulmonary exercise testing, especially when it features breath-by-breath gas exchange analysis, requires meticulous attention to calibration procedures to assure accurate and reproducible measurements. A good practice is to calibrate the system daily and to maintain a calibration log book so that long-term trends can be monitored.

Daily calibration begins with the determination of ambient barometric pressure, temperature, and relative humidity. The exercise system must be calibrated daily (or ideally before each test if more than one test is done) to check the operation of key transducers. Verification of calibration of the air flow or volume transducer can be performed with a calibrated 3-L syringe. A range of flow rates should be performed to simulate the wide range of flow rates that occur in going from rest to heavy exercise; syringe strokes varying from less than 1 to 15 seconds in duration cover most of this range. Agreement in calculated volumes to within $\pm 3\%$ signifies adequate performance.

Although the output of most CO₂ and O₂ gas analyzers is a nonlinear function of gas concentrations, electronic algorithms aim to create linear outputs over the desired operating range. For CO₂, this is 0–8%; for oxygen this is 13–21% (unless testing while breathing hyperoxic gas mixtures is intended). Daily two-point calibrations of each analyzer with two precision-analyzed gas mixtures should be performed. Typically this is done with one 6% CO₂ and 15% O₂ tank and one 0% CO₂ and 21% O₂ tank. On occasion, additional certified tanks with other relevant

TABLE 6. REPRODUCIBILITY OF VARIABLES MEASURED DURING CARDIOPULMONARY EXERCISE TESTING

First author (Ref.)	Sample Characteristics	Sample Size	Exercise Protocol	Statistical Analysis*	$\dot{V}O_2$	$\dot{V}CO_2$	HR	$\dot{V}E$	V_T	f_R	AT	O ₂ Pulse	Systolic BP	Sp _{O₂}	Work Rate/	Learning Effect
															Exercise Duration	
Garrard (255)	Normals	6	Max.	Coefficient of variation, %	8.4		3.8	12.0	4.4	9.1	12.1				5.5 [†]	No
Nordrehaugh (257)	Normals	10	Max.	Coefficient of variation, %	5.0		3.0	7.0			13.0				7.0 [†]	Yes
Wilson (256)	Normals	7	Max.	ANOVA/covariance												No
Belman (261)	COPD	11	Submax.													Yes
Brown (263)	COPD	11	Max.	Least significant difference/ \bar{x} , %	8.7	8.6	8.6	12.3	11.3	15.0		13.7			7.3 [†]	No
Cox (262)	COPD	11	Max.	Coefficient of variation, % (relative duplicate error, %)	3.0 (3.5)	5.0 (6.0)	3.0 (3.7)	5.0 (6.6)		6.0 (8.3)					3.7 [†] (4.5)	No
Nosedá (259)	COPD	20	Max.	Coefficient of variation, %	9.0		5.0	8.1							9.7 [†]	No
Owens (260)	COPD	13	Max.	Coefficient of variation, %	6.6	9.6	3.5	6.3		6.2					13.8 [†]	No
Swinburn (258)	COPD	17	Max.													Yes
Marciniuk (264)	ILD	6	Max.	Coefficient of variation, %	5.3		4.0	5.5	4.6	5.8				2.5	5.6 [†] /7.9 [†]	No
Elborn (265)	CHF	30	Max.	Coefficient of variation, %	6.0	9.0	8.0	8.0		7.0			5.0		7.0 [†]	Yes
Janicki (266)	CHF	16	Max.	Coefficient of variation, %	5.7		4.4				9.2		6.7		7.2 [†]	No
Meyer (267)	CHF	11	Max.	Coefficient of variation, %	4.1	6.4	1.4	6.3				4.4	2.2		3.6 [†]	

Definition of abbreviations: ANOVA = analysis of variance; AT = anaerobic threshold; BP = blood pressure; CHF = chronic heart failure; COPD = chronic obstructive pulmonary disease; f_R = respiratory frequency; HR = heart rate; ILD = interstitial lung disease; Max. = maximal; Sp_{O₂} = arterial oxygen saturation as indicated by pulse oximetry; Submax. = submaximal; $\dot{V}CO_2$ = carbon dioxide output; $\dot{V}E$ = minute ventilation; $\dot{V}O_2$ = oxygen uptake; V_T = tidal volume.

Adapted by permission from Reference 264.

* The numbers displayed correspond to the results of the statistical variable listed in the statistical analysis column. Coefficient of variation is the ratio of the standard deviation to the mean expressed as a percentage.

[†] Work rate.

[‡] Exercise duration.

compositions should be used to verify linearity. A good practice is to maintain a single precision gas cylinder (grandfather) for occasional use; such a tank can last a number of years and provide long-term validation of calibration accuracy.

A third routine calibration must be performed in systems featuring breath-by-breath gas exchange measurements. The transport delays between the gas sampling point and each gas analyzer need to be known with precision so that the respiratory airflow and gas concentration signals can be properly time aligned. A solenoid allows an abrupt switch between two gas sources with different O₂ and CO₂ compositions, and the time delays between solenoid activation and the detection of change in gas analyzer output are measured. This should be an automated process provided by the manufacturer so that the delay time can be checked or changed on a daily basis.

Gas exchange simulators/calibrators have been developed (248–250) for quality control of gas exchange measurements on automated systems. They feature a reciprocating piston; injection of a precision gas mixture at a precisely metered rate yields simulation of known $\dot{V}E$, $\dot{V}CO_2$, and $\dot{V}O_2$. Day-to-day variation of these calculations and the variation with changes in pump rate should be roughly in the range of $\pm 3\%$. However, these simulators have not been well validated. It should be noted that these gas exchange simulators do not simulate the normal variation in breathing pattern waveforms nor do they simulate moist, room temperature exhalate. Thus, effectiveness of drying exhaled air before analysis, or application of temperature and humidity corrections, are not tested. Therefore, these calibrators are perhaps most useful for the detection of variations in the performance of the system (precision) rather than accuracy.

Other calibration procedures need to be performed, but on a less frequent basis. Blood pressure transducers can be calibrated periodically with a mercury manometer, but with modern disposable units this calibration is not meaningful unless performed daily, which is often not practical. Most electrically braked cycles have static calibration procedures that can be performed as a checkup procedure. However, some errors can be introduced by several factors, especially motion. That is why the electrically braked cycle ergometer requires dynamic calibration with the use of a dynamometer (torque meter) (251–253), which should be performed yearly or whenever the cycle ergometer is moved

(jarring often disturbs the calibration). For most clinical testing purposes, the calibration should be linear in the range of 0 to 400 W. Because most laboratories do not have access to a dynamometer, cycle ergometer manufacturers should provide this service. Currently, this is also available from independent commercial vendors. For treadmills, belt speed should be verified by timing revolutions of the belt with a subject on the treadmill; accuracy of the grade indication should also be validated (191).

There are two other overall calibration checks that are advisable. The first is a physiologic/biologic validation (254), in which a healthy member of the laboratory staff, consuming a stable diet, performs a constant work rate test at varying workloads (50 and 100 or 150 W, etc.) at regular intervals depending on machine use (247). Subsequent steady state values for $\dot{V}E$, $\dot{V}O_2$, and $\dot{V}CO_2$ are then compared with the database and values outside the 95% CI for that individual should engender a thorough system-wide reassessment. If within tolerance, they are then added to the quality control database. Finally, timed expired gas collections (Douglas bag) made during steady state exercise can be used as a gold standard to validate ventilation and gas exchange measurements. Although laborious, when carefully done this method is generally accurate to within 2–3% for healthy subjects undergoing moderate to heavy exercise.

1.10. Reproducibility of measurements. It is important to take into consideration the reproducibility of the variables measured during clinical exercise testing for appropriate interpretation of the results (Table 6). Factors that may contribute to variability in these measurements include the following:

1. Changes in the underlying disease process(es)
2. Changes in medication
3. Patient motivation
4. Patient instructions/inducement
5. The time of day
6. Testing procedures
7. Equipment/calibration errors

Care must be taken to ensure that these factors, which may contribute to alteration of measured exercise responses, are meticulously controlled.

A number of studies have closely examined the variability

of measurements obtained during clinical exercise testing. The results of studies of normal subjects (255–257), of patients with chronic obstructive pulmonary disease (COPD) (258–263), of patients with interstitial lung disease (ILD) (264), and of patients with chronic heart failure (265–267) are outlined and summarized in Table 6.

In addition to specific guidelines for individual measurements, a number of other factors may influence the reproducibility of results. An important factor to consider is that of a potential learning effect (Table 6), and therefore the need for preliminary/familiarization testing. Various studies have provided conflicting results, with some reporting a significant change with repeated testing (257, 258, 261, 265), and others reporting no significant change (255, 256, 259, 260, 262–264, 266). A number of reasons may explain these discrepancies, and include whether the test was submaximal (i.e., not maximal and symptom limited), whether repeated testing was undertaken within a short period of time (i.e., four tests within 7–10 days), and whether there were changes in the underlying disease process (e.g., chronic heart failure). An additional factor that may influence the reproducibility of measurements is the time of testing. Preferably, repeated testing should be undertaken at the same time of day, as significant diurnal variation in results has been reported (255). Furthermore, the testing protocol, procedure, and instructions to the patient must be rigidly controlled, as these have been shown to significantly affect performance (258, 268). Finally, disease severity may also affect the variability of some measurements during exercise (266), and may affect the interpretation of results in some patients with more severe disease.

2. Exercise Test with Arterial Blood Sampling

An important clinical decision is whether CPET requires the placement of an arterial catheter for arterial blood sampling (269). Usually a noninvasive clinical test is adequate for clinical purposes. However, if the main purpose of the test is to determine the adequacy of pulmonary gas exchange, arterial blood sampling should be considered. Examples of situations in which arterial blood sampling should be considered are as follows: (1) patients with known disease states in which pulmonary gas exchange abnormalities are common, such as interstitial lung disease, pulmonary vascular disease, and chronic obstructive pulmonary disease with low DL_{CO} (3, 270, 271); (2) patients for whom determination of desaturation by pulse oximetry is considered less reliable (e.g., dark-skinned individuals) (13, 242, 246); (3) patients for whom an accurate measurement of oxygenation is needed (e.g., for prescription of supplemental oxygen); and (4) patients with abnormal initial CPET results, and concerning whom uncertainty persists regarding abnormality of pulmonary gas exchange, that is, whether increased \dot{V}_E/\dot{V}_{CO_2} is due to hyperventilation versus increased dead space ventilation. Additional investigation of the utility and indications of arterial sampling in clinical exercise testing is required.

The ability to exchange oxygen is best assessed by arterial oxygen pressure (Pa_{O_2}) measurement and calculation of the alveolar-arterial difference for oxygen pressure [$P(A-a)O_2$]. Pulse oximetry is frequently used as an alternative to these evaluations; however, it is a suboptimal substitute.

The efficiency of CO_2 exchange is best assessed by measuring Pa_{CO_2} and calculating the ratio of physiologic dead space to tidal volume (V_D/V_T). This calculation requires measurement of Pa_{CO_2} and mixed expired PCO_2 . Note that approaches that substitute end-tidal PCO_2 for Pa_{CO_2} (“noninvasive V_D/V_T ”) yield unreliable results (272, 273), principally because a positive difference between Pa_{CO_2} and PET_{CO_2} during exercise is, itself, a measure of a pulmonary gas exchange abnormality (3).

A desirable blood sampling strategy is to sample at rest, at

the end of unloaded pedaling, every other minute during the incremental phase and after 2 minutes of recovery. This strategy requires insertion of an arterial catheter, preferably into the radial artery because there is collateral circulation to the hand through the ulnar artery in the rare event of artery occlusion. Allen’s test should be performed before placing the arterial line. If the catheter cannot be placed in the radial artery, the brachial artery can be considered. It is possible to gain important diagnostic information from a single blood sample drawn from the radial artery. The optimal timing of this sample is near maximal exercise. Assessing exercise gas exchange from a sample obtained from a single arterial puncture at peak exercise when the patient is struggling to finish the test or immediately postexercise, when the gas exchange milieu is already different from peak exercise conditions, is to be discouraged. Pa_{O_2} changes occur rapidly after the end of exercise and clinically significant abnormalities present at peak exercise can be missed (274).

Work has suggested that arterial blood samples obtained during Minute 5 of a constant work protocol above the anaerobic threshold (70% of maximal incremental exercise test [IET] work rate) are comparable to those obtained near maximal exercise during an IET at a matched \dot{V}_{O_2} (275, 276) (see Section III,3.3: CONSTANT WORK RATE PROTOCOL). Additional investigation is required.

Blood samples should be analyzed promptly; PCO_2 , PO_2 , and pH are the key variables. Co-oximetry is often useful, but only mandatory to rule out elevated carboxyhemoglobin or methemoglobin levels. Lactate, standard bicarbonate, or base excess analysis is helpful to confirm noninvasive anaerobic threshold (AT) determination and to assess the magnitude of exercise lactic acidosis.

3. Exercise Testing Protocols

There are several protocols that can be used with either a cycle ergometer or a treadmill. Classification is based on the manner in which the work rate is applied (277): (1) progressive incremental exercise (every minute) or continuous ramp protocol; (2) a multistage exercise protocol (every 3 minutes, with a “pseudo”-steady state at each level); (3) a constant work rate (the same work rate, usually for 5 to 30 minutes); or (4) a discontinuous protocol, which consists of short periods (3–4 minutes) of constant work rate exercise separated by resting periods and with loads progressively increased (rarely used clinically).

3.1. Maximal incremental cycle ergometry protocols. This protocol is widely used in clinical practice (Figure 3). A progressively increasing work rate protocol enables rapid acquisition of diagnostic data. Because the responses of the variables of key interest (\dot{V}_E , \dot{V}_{CO_2} , and \dot{V}_{O_2}) lag behind changes in work rate, it is important to employ a protocol in which work rate increases at a constant rate. For the same reason, it is best to begin the incremental phase of exercise from a baseline of unloaded pedaling (“0 W”), rather than rest. An efficient IET protocol consists of 3 minutes of rest, followed by 3 minutes of unloaded pedaling followed by the incremental phase of exercise every minute (5 to 25 W/minute) until the patient reaches volitional exhaustion or the test is terminated by the medical monitor (see Section III,4.3.3: CRITERIA FOR TERMINATING EXERCISE TEST). With the introduction of computer-controlled cycle ergometers, it is possible to increase the work rate continuously, usually every 1 to 2 seconds in a ramplike fashion (ramp protocol) (193, 197, 278). However, the total increment per minute should be similar to that of the previous protocol, that is, 5 to 25 W/minute. Similar metabolic and cardiopulmonary values have been obtained when using the 1-minute incremental test or the ramp protocol (193, 196–198, 247).

Exercise tests in which the incremental phase lasts 8–12 min-

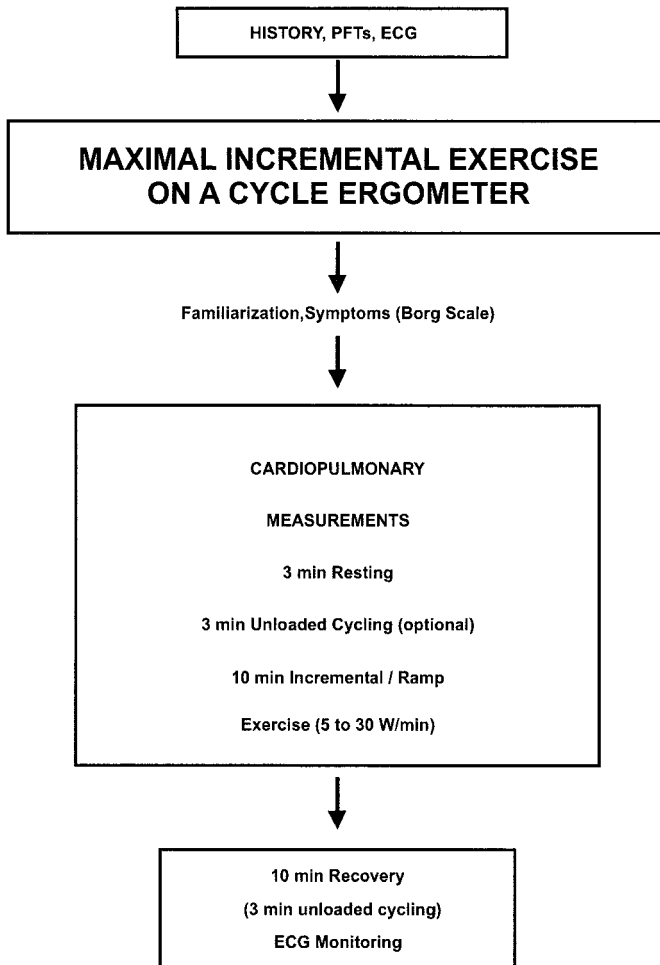

Figure 3. Flow chart of a maximal symptom-limited cardiopulmonary incremental protocol on a cycle ergometer. ECG = electrocardiogram; PFT = pulmonary function test.

utes are efficient and provide useful diagnostic information (182). In healthy subjects (healthy in the sense that the predicted $\dot{V}_{O_2\max}$ is achieved) it is possible to estimate the rate of work rate increment that will yield an incremental phase of about 10 minutes in duration. Because the \dot{V}_{O_2} -work rate relationship is approximately linear for incremental exercise and has a slope of about 10 ml/minute per watt, the \dot{V}_{O_2} after 10 minutes of incremental exercise will be

$$\dot{V}_{O_{2t=10\text{ minutes}}} = \dot{V}_{O_{2\text{unl}}} + (10 - \tau) \times 10 \times S$$

where $\dot{V}_{O_{2\text{unl}}}$ is the predicted oxygen uptake for unloaded pedaling, τ is the time constant (time required for 63% of the response to a stepwise increase in work rate) of \dot{V}_{O_2} (roughly 0.75 minute, although it may be shorter in young subjects and longer in older or chronically ill subjects), and S is the slope of rate of work increase in watts per minute. To achieve the predicted $\dot{V}_{O_{2\max}}$ in 10 minutes (i.e., \dot{V}_{O_2} (10 min) = predicted $\dot{V}_{O_{2\max}}$),

$$S = \frac{\dot{V}_{O_{2\max}} - \dot{V}_{O_{2\text{unl}}}}{92.5}$$

Prediction equations are available for $\dot{V}_{O_{2\max}}$ and $\dot{V}_{O_{2\text{unl}}}$ (3). Deviation from the watts per minute calculated using the equation should be based on clinical judgment and knowledge of the subject's physical activity. For the subject who appears to be fit, work rate increments as high as 25–30 W/minute may

be selected. For debilitated patients, lower work rate increments (e.g., 5 W/minute) may be selected.

New protocols have been introduced for clinical exercise testing; among them is the standardized exponential exercise protocol, which was designed to allow a single protocol to be used for subjects with a wide range of exercise capacities (279, 280). This protocol is suitable for use on either a cycle ergometer or a treadmill. In this protocol the work rate is increased exponentially by 15% of the previous workload every minute. Because bicycle exercise is relatively independent of body weight, the protocol is adjusted for different body weights. This protocol should elicit similar \dot{V}_{O_2} in ml/kg per minute at each stage for different individuals; the most severely debilitated patients will exercise for fewer minutes and the more fit for about 15 minutes. No clear advantage has been shown in the use of this protocol over conventional protocols.

3.2. Maximal incremental treadmill protocols. If a treadmill is used (281), an incremental protocol, similar to that for a cycle ergometer, may be used. The lowest treadmill speed (e.g., 0.6–1.0 mph) may be used for the exercise baseline. The work rate can then be incremented at regular intervals with a combination of speed and grade. The Bruce protocol, originally designed for testing and for the evaluation of coronary artery disease (282), may be used for more functional subjects. However, the work rate of its first stage (5 metabolic equivalents [METs]) and the subsequent increments (2 to 4 METs) are high (i.e., equivalent to increases of about 50 W per stage for an average person) and may not be achievable in patients with moderate to severe cardiac and/or pulmonary disease. For these patients, a modified Naughton protocol may be utilized, in which the initial work rate and subsequent increments are more than 1 but less than 2 METs (283). A drawback of both protocols, however, is the relatively long increment duration (3 minutes), which is likely to impair noninvasive assessment of the lactate threshold.

For cardiopulmonary measurements, the Balke protocol (284), in which the speed is kept constant at 3.3 mph, and elevation is increased by 1% every minute, and the modified Balke protocol, in which a fixed treadmill speed is chosen and the treadmill grade is increased by a constant amount each minute (3, 285), are the most appropriate. These protocols most closely approximate a constant rate of increase in work rate. Other incremental treadmill protocols that combine speed and grade changes have also been used for evaluating patients with pulmonary disease (286). As mentioned previously, the standardized exponential exercise protocol has also been designed for use with treadmills (279, 280). At each stage either the treadmill speed or the elevation is increased to elicit a 15% increase in work rate. The same protocol can be used for individuals of different body weights and obtain similar \dot{V}_{O_2} in ml/kg per minute for each stage. Again, no clear advantage has been shown in the use of this protocol over more conventional and well-established exercise protocols for CPET.

In cardiology, and especially when treadmill protocols are used, it is common to express the metabolic requirement for external work as the metabolic equivalent (MET). "MET" is defined as the equivalent of the resting metabolic oxygen requirement. One metabolic equivalent equals 3.5 ml/kg per minute. Exercise capacity (in METs) is a powerful predictor of mortality among men referred for exercise testing (287)

3.3. Constant work rate protocol. This protocol is gaining popularity because of its clinical applicability, particularly for monitoring response(s) to a spectrum of therapeutic interventions including cardiopulmonary rehabilitation, bronchodilators LVRS, medical devices, and so on (88). It is also useful for the analysis of exercise tidal flow-volume loops and dynamic hyperinflation (45, 87, 247, 288), gas exchange kinetics (289–291), and validation of pulmonary gas exchange during incremental exercise testing (IET) (275).

TABLE 7. OVERVIEW OF CARDIOPULMONARY EXERCISE TESTING

Clinical Status Evaluation
Clinical diagnosis and reason(s) for CPET Health questionnaire (cardiopulmonary); physical activity profile Medical and occupational history and physical examination PFTs, CXR, ECG, and other appropriate laboratory tests Determination of indications and contraindications for CPET
↓
Pretest Procedures
Abstain from smoking for at least 8 h before the test Refrain from exercise on the day of the test Medications as instructed Consent form
↓
Conduct of CPET
Laboratory procedures Quality control Equipment calibration Protocol Selection Incremental versus constant work rate; invasive versus noninvasive Patient preparation Familiarization 12-lead ECG, pulse oximetry, blood pressure Arterial line (if warranted) Cardiopulmonary exercise testing
↓
Interpretation of CPET Results
Data processing Quality and consistency of results Comparison of results with appropriate reference values Integrative approach to interpretation of CPET results Preparation of CPET report

Definition of abbreviations: CPET = cardiopulmonary exercise testing; CXR = chest X-ray; ECG = electrocardiogram; PFTs = pulmonary function tests.

If additional pulmonary gas exchange information (ABG data) is required after an IET has been performed, it may be appropriate to perform a constant work rate protocol (276). Treadmill or cycle ergometry exercise may be used at levels approximating the subject's usual daily activities (e.g., up to 3.0 mph on a treadmill, or up to 50 W on a cycle ergometer). A constant work rate may be performed about 1 hour after an IET. This test should involve at least 6 minutes of continuous exercise. Alternatively, using 50 to 70% of the maximal work rate achieved during an incremental exercise, a constant work rate test for 5 to 10 minutes often achieves about 70 to 90% of $\dot{V}_{O_2\max}$ achieved during IET. ABGs obtained at Minute 5 by single radial artery puncture approximate nearly maximal IET values and may provide an alternative to an arterial line (275, 276). Additional studies are required.

4. Conducting the test. The clinical exercise test order should include reasons for the test and clinical diagnosis with a summary of the medical history (Table 7). The patient, with the help of the exercise technologist, should fill out a short questionnaire. This should include questions related to cardiopulmonary and major systemic diseases and current therapy, with special attention to medications that alter heart rate (HR) and blood pressure. Furthermore, risk factors for coronary artery disease, such as smoking history, chest pain, cholesterol, hypertension, overweight, and family history should be assessed. Questions about daily physical activity and involvement in a regular program of physical conditioning should be included (*see* Section VIII,3.2: CLINICAL STATUS EVALUATION). The taking of a brief medical history and physical examination are recommended (*see* Section III,4.3: PATIENT SAFETY) (42, 292); however, the clinical judgment of the physician in charge of the test should prevail. It may be

helpful to have a screening visit; the patient may benefit from exercise familiarization that includes pedaling on the cycle ergometer at a low work rate or walking on the treadmill, with the mouthpiece, noseclip, and monitoring devices in place. This can provide a good opportunity to explain communication techniques during the test, including hand signs, symptoms scoring (Borg Scale of Perceived Exertion [Borg Scale]), and so on.

4.1. Preliminary requirements for exercise testing. The following are required: (1) spirometry and maximal voluntary ventilation (MVV) should be measured, and lung volumes and DL_{CO} can be included if clinically warranted; (2) if hypoxemia is clinically suspected, resting arterial blood gases should be obtained; (3) a recent hemogram and electrolytes should be determined, if warranted; (4) patients who smoke should be asked to abstain from smoking for at least 8 hours; (5) consultation with a cardiologist is recommended, when appropriate, for patients with a history of coronary artery disease; (6) for functional evaluation and disability, patients should be tested with their optimal medication regimen; (7) the morning of the test, patients should not exercise and should have a light breakfast no less than 2 hours before the test; and (8) patients should come to the laboratory in exercise clothing, including tennis shoes.

4.2. Day of the test. On the basis of the preliminary evaluation, a decision must be made concerning whether an invasive test is warranted (*see* Section III,2: EXERCISE TEST WITH ARTERIAL BLOOD SAMPLING). A consent form must be signed. With patient properly dressed, place the ECG electrodes and indwelling arterial catheter, if necessary. A supine resting 12-lead ECG should be obtained and used as the "standard" ECG tracing for determination of resting abnormalities before exercise testing (293).

4.3. Patient safety.

4.3.1. Foreseeable risk of cardiopulmonary exercise testing. In general, maximal symptom-limited exercise testing is a relatively safe procedure, especially in otherwise healthy individuals. In a survey of 1,375 clinical exercise testing facilities, the risk of dying during cardiopulmonary exercise test was of 0.5 per 10,000 tests (294). However, in another study, it was reported that in more than 70,000 maximal exercise tests performed in a preventive medicine clinic, no deaths occurred, with only 6 major medical complications (295). Scherer and Kaltenbach (296) reported on 1,065,923 tests, mostly cycle ergometry, performed in Europe. No mortality or morbidity was reported in 353,638 stress tests involving "sports persons," whereas among 712,285 patients with coronary disease, 17 deaths and 96 life-threatening complications were reported. The authors concluded that cycle ergometry in a chronic disease population resulted in 2 deaths per 100,000 tests. In another study based on 458,000 exercise tests conducted in France (297), 1 death per 76,000 exercise tests was reported. The American Heart Association analyzed eight studies related to sudden death during exercise testing (10). The reported rates were 0 to 5 per 100,000 exercise tests. A survey of the Veterans Affairs Health Care System exercise laboratories found an event rate of 1.2 per 10,000 tests of major cardiac events (myocardial infarction, ventricular tachycardia) and no deaths during 75,828 exercise tests performed within the last year (298). In summary, it can be concluded that the risk of medical complications is related to the underlying disease, and it appears that the rate of death for patients, during exercise testing, is 2 to 5 per 100,000 clinical exercise tests.

4.3.2. Contraindications to exercise testing. An important concept to bear in mind when considering whether it is safe to test an individual patient is that exercise is a ubiquitous activity that goes on outside as well as inside the laboratory. In the laboratory environment a number of physiologic responses are monitored. Professionals experienced in interpreting exercise responses closely observe the patient. Resuscitation equipment

TABLE 8. ABSOLUTE AND RELATIVE CONTRAINDICATIONS FOR CARDIOPULMONARY EXERCISE TESTING

Absolute	Relative
Acute myocardial infarction (3–5 days)	Left main coronary stenosis or its equivalent
Unstable angina	Moderate stenotic valvular heart disease
Uncontrolled arrhythmias causing symptoms or hemodynamic compromise	Severe untreated arterial hypertension at rest (> 200 mm Hg systolic, > 120 mm Hg diastolic)
Syncope	Tachyarrhythmias or bradyarrhythmias
Active endocarditis	High-degree atrioventricular block
Acute myocarditis or pericarditis	Hypertrophic cardiomyopathy
Symptomatic severe aortic stenosis	Significant pulmonary hypertension
Uncontrolled heart failure	Advanced or complicated pregnancy
Acute pulmonary embolus or pulmonary infarction	Electrolyte abnormalities
Thrombosis of lower extremities	Orthopedic impairment that compromises exercise performance
Suspected dissecting aneurysm	
Uncontrolled asthma	
Pulmonary edema	
Room air desaturation at rest \leq 85%*	
Respiratory failure	
Acute noncardiopulmonary disorder that may affect exercise performance or be aggravated by exercise (i.e. infection, renal failure, thyrotoxicosis)	
Mental impairment leading to inability to cooperate	

Adapted by permission from References 10, 43, and 295.

* Exercise patient with supplemental O₂.

is immediately available. Outside the laboratory, the patient must exercise without these safeguards! Therefore, it can be postulated that there are only a few absolute contraindications to exercise testing (13, 42, 292) (Table 8). Among these are syncope, unstable angina, uncontrolled systemic hypertension, or the presence of serious cardiac dysrhythmias on the resting electrocardiogram (e.g., severe bradycardia or tachycardia, sick sinus syndrome, or multifocal premature ventricular contractions) (292, 299). Also, in patients with primary pulmonary hypertension pulmonary artery pressure often increases with exercise and there is an increased risk of sudden death (107, 300) (*see* Section II,4.3: INDICATIONS and Section VIII,4.2: PULMONARY VASCULAR DISEASE). Although caution is advised when exercise testing patients with primary pulmonary hypertension, CPET can be performed safely (105). Of course, patients who are unable to exercise because of neurological or orthopedic problems are not candidates for exercise testing. Those patients whose debility is limited to the lower extremities may be candidates for arm-cranking ergometry, although the peak $\dot{V}O_2$ (and thus the stress to the cardiac and pulmonary systems) for arm exercise averages only roughly 70% of peak $\dot{V}O_2$ for leg exercise in healthy subjects (201, 204).

4.3.3. Criteria for terminating the exercise test. In the vast

majority of cardiopulmonary exercise tests, patients should be verbally encouraged before and during the test, to give a maximal effort with the goal of achieving physiologic limitation (*see* Section VIII,3.7: ASSESSMENT OF PATIENT EFFORT). In particular, it should be stressed that exceeding a preset heart rate criterion is not a useful criterion for stopping exercise. The most accepted criteria for exercise termination before symptom limitation are listed in Table 9 (12, 14, 43, 281).

In situations in which the monitor stops the exercise test, the patient should be observed until the patient is stable and physiologic variables have returned to baseline conditions. If necessary and based on the criteria of the physician, admission to the hospital may be warranted. Resuscitation equipment should always be available in the exercise laboratory.

5. Personnel Qualifications

The human performance or clinical exercise laboratory should be under the direction of a physician, preferably a pulmonologist or cardiologist certified in advanced cardiovascular life support, with knowledge of exercise physiology and with training in calibration, quality control, performance, and interpretation of cardiopulmonary exercise testing. He/she will be responsible for the clinical decisions, including clinical evaluation, determination of

TABLE 9. INDICATIONS FOR EXERCISE TERMINATION

Chest pain suggestive of ischemia
Ischemic ECG changes
Complex ectopy
Second or third degree heart block
Fall in systolic pressure > 20 mm Hg from the highest value during the test
Hypertension (> 250 mm Hg systolic; > 120 mm Hg diastolic)
Severe desaturation: Sp _{O₂} \leq 80% when accompanied by symptoms and signs of severe hypoxemia
Sudden pallor
Loss of coordination
Mental confusion
Dizziness or faintness
Signs of respiratory failure

Definition of abbreviations: ECG = electrocardiogram; Sp_{O₂} = arterial oxygen saturation as indicated by pulse oximetry.

Adapted by permission from References 12, 14, 43, and 281.

TABLE 10. MEASUREMENTS DURING CARDIOPULMONARY EXERCISE TESTING

Measurements	Noninvasive	Invasive (ABGs)
External work	WR	
Metabolic gas exchange	$\dot{V}O_2$, $\dot{V}CO_2$, RER, AT	Lactate
Cardiovascular	HR, ECG, BP, O ₂ pulse	
Ventilatory	\dot{V}_E , V _T , f _R	
Pulmonary gas exchange	Sp _{O₂} , $\dot{V}_E/\dot{V}CO_2$, $\dot{V}_E/\dot{V}O_2$, PET _{O₂} , PET _{CO₂}	Pa _{O₂} , Sa _{O₂} , P(A-a)O ₂ , V _D /V _T
Acid-base		pH, Pa _{CO₂} , standard HCO ₃ ⁻
Symptoms	Dyspnea, fatigue, chest pain	

Definition of abbreviations: ABGs = Arterial blood gases; AT = anaerobic threshold; BP = blood pressure; ECG = electrocardiogram; f_R = respiratory frequency; HR = heart rate; P(A-a)O₂ = alveolar-arterial difference for oxygen pressure; Pa_{CO₂} = arterial carbon dioxide pressure; Pa_{O₂} = arterial oxygen pressure; PET_{CO₂} = end-tidal PCO₂; PET_{O₂} = end-tidal PO₂; RER = respiratory exchange ratio; Sa_{O₂} = arterial oxygen saturation; Sp_{O₂} = arterial oxygen saturation as indicated by pulse oximetry; $\dot{V}CO_2$ = carbon dioxide output; \dot{V}_E = minute ventilation; V_D/V_T = ratio of physiologic dead space to tidal volume; $\dot{V}O_2$ = oxygen uptake; V_T = tidal volume; WR = work rate. Adapted by permission from Reference 28.

the type of test to be performed, monitoring of the patient during the test, interpretation of the results, and provision of appropriate recommendations including exercise prescription. The physician is responsible for the well-being of the patient while in the laboratory. On the basis of the clinical situation and clinical judgment, the physician should determine whether a physician needs to be present during the actual test or whether it is sufficient for the physician to be physically available in the proximity of the exercise laboratory, so as to be able to respond immediately in case of an emergency.

The technicians should be trained in a field related to cardiopulmonary exercise testing such as exercise physiology, respiratory therapy, or pulmonary function testing. The technicians must have basic knowledge of normal and abnormal exercise responses and be certified in basic cardiac life support. They should be able to recognize an abnormal rhythm and ST depression on an electrocardiogram. The technician must have a minimum of 3 months of experience or internship in cardiopulmonary exercise testing before being given full responsibility for conduct of tests. He or she should be competent in calibrating the equipment, performing quality control procedures, and conducting a clinical exercise test. The American College of Sports Medicine has established a system to credential technicians in clinical exercise testing (14).

IV. CONCEPTUAL AND PHYSIOLOGIC BASIS OF CARDIOPULMONARY EXERCISE TESTING MEASUREMENTS

An impressive number of variables are typically measured during cardiopulmonary exercise testing (Table 10). However, the number of variables that are required in any situation will depend on the reason(s) for which exercise testing was requested. Suggested graphic interrelationships between the most important measurements during CPET appear in Table 11.

Although the meaning and limitations of each of the measurements will be considered individually, for the purpose of optimal interpretation, the greatest diagnostic potential and impact on the clinical decision-making process rests not on the utility of any one individual measurement, but rather on their integrated use (see Section VIII: INTERPRETATION).

The focus of this section is to review physiologic measurements commonly assessed during CPET and to note salient features of the normal response to exercise.

1. Oxygen Uptake

Oxygen uptake ($\dot{V}O_2$) is determined by cellular O₂ demand up to some level that equates to maximal rate of O₂ transport, which

then is determined by that maximal rate of transport. $\dot{V}O_2$ can be computed from blood flow and O₂ extraction by the tissues, as expressed in the Fick equation (see Section IV,5: CARDIAC OUTPUT). Factors that can influence O₂ availability are oxygen-carrying capacity of the blood (available hemoglobin, arterial O₂ saturation (Sa_{O₂}), and dissociation curve shifts with temperature, CO₂, and pH), cardiac function (HR, stroke volume [SV]), redistribution of peripheral blood flow, and extraction by the tissues (capillary density, mitochondrial density and function, adequacy of perfusion, and tissue diffusion).

1.1. $\dot{V}O_2$ -Work Rate Relationship. Normally, $\dot{V}O_2$ increases nearly linearly as external work (power output) increases. However, accurate determination of the external work rate in watts (or kilopond · meters [kpm] per minute) is required to determine this relationship. The external work rate is accurately measured by cycle ergometry but can only be estimated by treadmill exercise. The slope of $\dot{V}O_2$ versus external work rate reflects the efficiency of the metabolic conversion of chemical potential energy to mechanical work and the mechanical efficiency of the musculoskeletal system. The slope determined from the rate of change in $\dot{V}O_2$ divided by the rate of change in external work during incremental exercise testing on a cycle ergometer ($\Delta\dot{V}O_2/\Delta WR$) is normally about 8.5–11 ml/minute per watt (3, 195) and is independent of sex, age, or height. Obese individuals may show an increase in $\dot{V}O_2$ for a given external work rate, but the rate of rise in $\dot{V}O_2$ with increasing external work rate (slope) is normal (301, 302). Because there are few processes that affect the metabolic efficiency of muscles, a reduction in the value of this relationship most often indicates inadequacies of O₂ transport, as may occur with diseases of the heart, lungs, or circulation. However, an abnormal O₂ utilization process—mitochondrial myopathy (54) and the muscle-related abnormality in oxygen

TABLE 11. SUGGESTED GRAPHIC INTERRELATIONSHIPS OF KEY CARDIOPULMONARY VARIABLES DURING EXERCISE

Ordinate (y axis)	Abscissa (x axis)
$\dot{V}O_2$	Work rate
\dot{V}_E	V _{CO₂} or $\dot{V}O_2$
V _T and f _R	$\dot{V}O_2$
HR and O ₂ pulse	$\dot{V}O_2$
$\dot{V}CO_2$	$\dot{V}O_2$
$\dot{V}_E/\dot{V}O_2$ and $\dot{V}_E/\dot{V}CO_2$	$\dot{V}O_2$
PET _{O₂} and PET _{CO₂}	$\dot{V}O_2$
Pa _{O₂} , P(A-a)O ₂ , and Sa _{O₂}	$\dot{V}O_2$
Pa _{CO₂} and V _D /V _T	$\dot{V}O_2$
[La ⁻] or HCO ₃ ⁻	$\dot{V}O_2$

Definition of abbreviations: See Table 10.

metabolism reported in cystic fibrosis (110)—may also be associated with a reduced $\dot{V}O_2$ -work rate slope (see Section VIII,5.2: IS METABOLIC RATE APPROPRIATE DURING EXERCISE?); further studies are needed to assess this issue.

1.2. $\dot{V}O_{2max}$ - $\dot{V}O_{2peak}$. As $\dot{V}O_2$ increases with increasing external work, one or more of the determinants of $\dot{V}O_2$ approach limitations (e.g., SV, HR, or tissue extraction) and $\dot{V}O_2$ versus work rate may begin to plateau. Achieving a clear plateau in $\dot{V}O_2$ has traditionally been used as the best evidence of $\dot{V}O_{2max}$. $\dot{V}O_{2max}$ is the best index of aerobic capacity and the gold standard for cardiorespiratory fitness. It represents the maximal achievable level of oxidative metabolism involving large muscle groups. However, in clinical testing situations, a clear plateau may not be achieved before symptom limitation of exercise (229, 303, 304). Consequently, $\dot{V}O_{2peak}$ is often used as an estimate for $\dot{V}O_{2max}$. For practical purposes, $\dot{V}O_{2max}$ and $\dot{V}O_{2peak}$ are used interchangeably. Aerobic capacity should be directly measured because its estimation from resting indices, work rate, or submaximal exercise protocols is limited by physiologic mechanisms and methodologic inaccuracies and as such are unreliable (12). In turn, direct measurement of $\dot{V}O_{2max}$ is reliable and reproducible in normal subjects and patients (Table 6). The main determinants of normal $\dot{V}O_{2max}$ or $\dot{V}O_{2peak}$ are genetic factors and quantity of exercising muscle. $\dot{V}O_{2max}$ or $\dot{V}O_{2peak}$ is also dependent on age, sex, and body size, and it can be affected by training. $\dot{V}O_{2peak}$ should be expressed in absolute values (liters per minute) and as a percentage of the predicted value. The selection of predicted values is critical and should reflect the population being tested (see Section V: REFERENCE VALUES).

$\dot{V}O_{2max}$ is often normalized by some index of body size. However, there is no consensus on the best method for adjusting for these indices. The most commonly used normalization is body weight in kilograms (American Heart Association, American College of Sports Medicine) and is the easiest to calculate. However, it may not be the most appropriate frame of reference for comparing or “normalizing” the metabolic rate across subjects of different sizes (305). Small but normal subjects have a higher $\dot{V}O_2$ per kilogram than larger subjects (305). Because fat metabolism does not contribute significantly to $\dot{V}O_{2max}$, normalization by body weight can produce deceptively low values in obese individuals. In obesity, normalization by height ($\dot{V}O_2/ht$) may prove to be a better correlate of lean body mass and, in turn, a more reliable index of aerobic capacity (3). Additional studies are necessary.

Some have suggested that $\dot{V}O_2$ referenced to lean body mass, also known as fat-free mass (FFM), would be a better index and has the further advantage of accounting for most of the sex differences in $\dot{V}O_{2max}$; however, its routine measurement would be difficult to implement in the clinical exercise laboratory (306, 307). In addition, population variance may be reduced by including both weight and height (169, 308); this can be done by using as a reference body mass index (wt/ht^2) or, preferably, by using fat-free mass index (FFM/ht^2).

Recommendation: $\dot{V}O_{2max}$ or $\dot{V}O_{2peak}$ should be expressed as an absolute value and as a percentage of the predicted value; $\dot{V}O_{2max}$ should also be referenced to body weight (in kilograms) and/or height in the formatting of the report so that the impact of body size on exercise results is readily recognized (see Section VIII,4.6: OBESITY). This is especially important in patients for whom actual weight is greater than ideal body weight.

$\dot{V}O_2$ can increase from a resting value of about 3.5 ml/minute per kilogram (about 250 ml/minute in an average individual) to $\dot{V}O_{2max}$ values about 15 times the resting value (30–50 ml/minute per kilogram). Athletes may attain values over 20 times their resting values (up to 80 ml/minute per kilogram) (309). A reduced $\dot{V}O_{2peak}$ may reflect problems with oxygen transport (cardiac output, O_2 -carrying capacity of the blood), pulmonary limitations (mechanical, control of breathing or gas exchange),

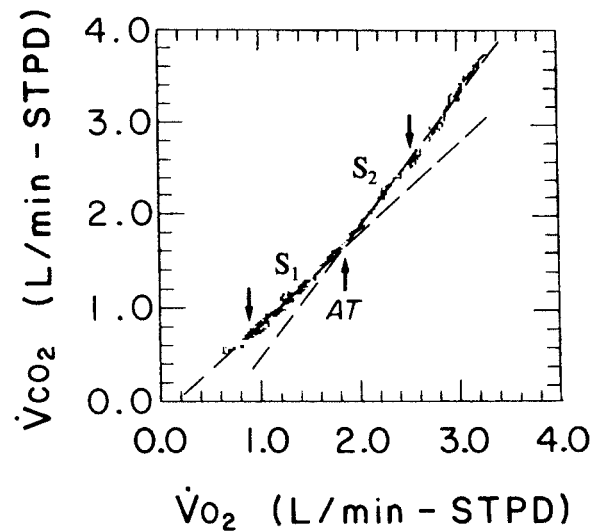

Figure 4. Determination of the anaerobic threshold, using the V-slope method (340).

oxygen extraction at the tissues (tissue perfusion, tissue diffusion), neuromuscular or musculoskeletal limitations, and, of course, effort. In addition, in patients, perceptual responses (symptoms) rather than a physiologic process as defined in the Fick equation may be responsible for a low $\dot{V}O_{2max}$. The multifactorial etiology of reduced $\dot{V}O_{2max}$ in many clinical settings has been increasingly appreciated (1, 5, 142, 143, 276, 310). Decreases in $\dot{V}O_{2max}$ or $\dot{V}O_{2peak}$ are therefore general indicators of reduced exercise capacity. Underlying causes of exercise limitation are determined, in turn, by inspecting the pattern of responses in other variables. A reduced $\dot{V}O_{2peak}$ is the starting point in the evaluation of reduced exercise tolerance.

Recommendation: $\dot{V}O_{2max}/\dot{V}O_{2peak}$ should be obtained from the maximal $\dot{V}O_2$ value measured during an incremental exercise protocol taken to symptom limitation even if a plateau in $\dot{V}O_2$ is not seen. Noteworthy symptoms should be appropriately recorded.

2. CO_2 Output

CO_2 output ($\dot{V}CO_2$) during exercise is determined by factors similar to those that govern O_2 uptake: cardiac output, CO_2 -carrying capacity of the blood, and tissue exchange are major determinants. However, because CO_2 is much more soluble in tissues and blood, CO_2 output measured at the mouth is more strongly dependent on ventilation than is $\dot{V}O_2$. In addition, because dissolved CO_2 is a weak acid, the body uses CO_2 regulation to compensate for acute metabolic acidosis, which affects the pattern of $\dot{V}CO_2$ as work intensity increases above the point of anaerobic metabolism (see below).

During short-duration exercise, glycogen is used primarily by the muscles for energy, and the relation between O_2 consumption and CO_2 production is almost equimolar. As such, during progressive exercise $\dot{V}CO_2$ increases nearly as much as does $\dot{V}O_2$ over the lower work rate range, with an average $\dot{V}CO_2$ - $\dot{V}O_2$ relationship (Figure 4, slope S_1) of slightly less than 1.0 (3). It should be recognized that the slope of the $\dot{V}CO_2$ -versus- $\dot{V}O_2$ relationship is not equal to the respiratory exchange ratio ($\dot{V}CO_2/\dot{V}O_2$), as the relationship usually has a small positive intercept on the $\dot{V}O_2$ axis. There is typically a relatively sharp change in slope toward the midrange of the $\dot{V}O_2$ response (Figure 4 [AT determined by V-slope method]). This results in a steeper, but typically quite linear, profile over the upper work rate range (Figure 4, slope

S₂). The steeper slope reflects the CO₂ generated in excess of that produced by aerobic metabolism due to bicarbonate buffering of increased lactic acid production at these high work rates. With anaerobic metabolism, \dot{V}_{CO_2} increases as a result of the chemical reaction between hydrogen ion (from lactate) and dissolved CO₂:



As tissue lactate production increases $[H^+]$, the reaction is driven to the right, producing extra CO₂ above that produced aerobically. The excess CO₂ may also come from reduction in the body CO₂ stores as a result of hyperventilation (manifested as arterial hypocapnia).

Because \dot{V}_E has been demonstrated to be closely proportionally coupled to \dot{V}_{CO_2} during exercise, it is useful to analyze \dot{V}_E in relation to \dot{V}_{CO_2} , although there are no well-established reference values for its clinical interpretation.

It is also important to accurately measure CO₂ output, as it is the basis for the calculation of several derived variables, including (1) the respiratory exchange ratio, (2) the respiratory quotient, (3) $P_{(A-a)O_2}$, (4) \dot{V}_D/\dot{V}_T , (5) alveolar ventilation, and so on.

3. Respiratory Exchange Ratio

The ratio of $\dot{V}_{CO_2}/\dot{V}_{O_2}$ is called the gas exchange ratio or respiratory exchange ratio (RER). Under steady state conditions, the RER equals the respiratory quotient (RQ), whose value is determined by the fuels used for metabolic processes. An RQ of 1.0 indicates metabolism of primarily carbohydrates, whereas an RQ of less than 1.0 indicates a mixture of carbohydrates with fat (RQ, about 0.7) or protein (RQ, about 0.8). The term “RQ” is often reserved for expressing events at the tissue level, which is difficult to measure and is not determined during clinical exercise testing. The term “RER” is usually measured by gas exchange at the mouth. In true steady state, the blood and gas transport systems are keeping pace with tissue metabolism; thus, the RER can be used as a rough index of metabolic events (RQ). However, an RER greater than 1.0 could also be caused by CO₂ derived from lactic acid or by hyperventilation because of the 20-fold or more higher tissue solubility of CO₂ compared with O₂. This difference in solubility is due both to the 20-fold higher direct solubility of CO₂ in water compared with O₂, and to the fact that $[HCO_3^-]$ and proteins are significant forms of transport for CO₂ in body tissues whereas the only significant form of transport for O₂ is by combination with hemoglobin. Thus, in practical testing situations, both lactic acidosis and hyperventilation must be considered when the RER is greater than 1.0.

Recommendation: The respiratory exchange ratio (RER) should be reported as a function of \dot{V}_{O_2} . Its value is obtained from the ratio of \dot{V}_{CO_2} to \dot{V}_{O_2} .

4. Anaerobic Threshold

The anaerobic threshold (AT), also known as the lactate threshold, lactic acid threshold, gas exchange threshold, or ventilatory threshold, is considered an estimator of the onset of metabolic acidosis caused predominantly by the increased rate of rise of arterial [lactate] during exercise. The AT is referenced to the \dot{V}_{O_2} at which this change occurs and is expressed as a percentage of the predicted value of \dot{V}_{O_2max} (% \dot{V}_{O_2max} predicted). The terminology selected to describe this transition has often reflected different methodologic approaches used for its determination.

The term AT, as the “estimator” of the \dot{V}_{O_2} at which the rate of change in arterial [lactate] rapidly increases, is the most widely used, has the greatest recognition, and is most probably preferable. Alternatively, “lactic acid threshold” is preferred by others but is less well established and should be used only when lactate is directly measured from blood samples. In turn, “ventilatory

threshold” implies that a ventilatory response has occurred and that it is due to metabolic acidosis, although the two may not be causally related. Regardless of which terminology is selected, clarification of which methodology is used is necessary.

After 30 years, the physiologic mechanisms underlying the increases in muscle and blood [lactate] that occur at the AT remain controversial (311–315). Although the classic views concerning the assessment of the AT have been supported by some investigators (316–320), others have continued to question this classic viewpoint (314, 321, 322).

4.1. Cellular basis. Energy for muscle contraction is provided by high-energy phosphate groups supplied in the form of adenosine triphosphate (ATP). ATP is supplied by the breakdown of glycogen to pyruvate, which enters the tricarboxylic acid (TCA) cycle via acetyl-coA, and breakdown of fats to produce acetyl-coA. Further processing of acetyl-coA in the TCA cycle and electron transport chain produces ATP needed for muscle contraction. If processing occurs only in the glycolytic pathway, a smaller amount of ATP is formed along with lactic acid. To produce ATP, the TCA and electron transport chains require oxygen, with the final by-products being water and CO₂. Cellular events defining oxidative and glycolytic processes during exercise are also impacted by muscle fiber type. Muscle fibers vary in the balance of oxidative versus glycolytic enzymes, that is, “aerobic” versus “anaerobic” metabolism. At low exercise intensities, fibers that are primarily oxidative are recruited, but as intensity increases, fibers that rely primarily on glycolytic pathways are recruited, thus increasing the output of lactic acid (323, 324). The extra acid produced causes an increase in \dot{V}_{CO_2} by buffering of CO₂ in the blood (*see above*). Controversy persists as to whether a deficiency of oxygen delivery versus oxidative capacity also contributes to the onset of lactic acid production, hence the term “anaerobic threshold.” It is possible that both processes, that is, the pattern of muscle fiber recruitment and a potential imbalance between oxygen supply and oxidative metabolism, contribute to the increase in lactic acid as exercise intensity increases.

Furthermore, there is no convincing evidence to substantiate that anaerobiosis at the cellular level is responsible for the increased arterial lactate above the AT; lactate accumulation may occur above and below a critical P_{O_2} , which suggests that other factors (i.e., glycolytic enzymes) may also be involved (314). As such, the term AT should be used in a descriptive sense. The relative contribution of the different sources of lactic acid may also vary with disease. For example, in heart failure reduced oxygen delivery may be the predominant factor, so that as exercise intensity increases, the rate of rise in \dot{V}_{O_2} starts to decline and the rate of rise in lactate increases earlier than in normal individuals (325, 326).

Regardless of mechanism, the increase in lactic acid that appears in the blood as exercise intensity increases has important physiologic consequences. First, the buildup in lactic acid reduces the pH of both blood and interstitial fluid, which in turn could ultimately compromise cellular function. Second, the reduced pH, or some event related to the change in pH, likely stimulates ventilation as the body attempts to buffer the increased acid by decreases in P_{CO_2} . Because lactic acid buildup affects cellular function, the magnitude of the rise in lactate and the pattern of rise in lactate relative to change in \dot{V}_{O_2} during exercise may be a useful diagnostic indicator in exercise testing. Also, the earlier lactate buildup occurs, the lower the long-term sustainable \dot{V}_{O_2} .

However, some authors have questioned whether the arterial [lactate] profile actually evidences threshold behavior (314, 321, 322). These findings (321, 322) were corroborated by other investigators (327) who, using venous blood lactate measurements, reported that in contrast to the “AT hypothesis,” their results

were more consistent with a continuous development of acidosis, rather than a sudden onset of blood lactate accumulation during progressive exercise. Finally, Myers and coworkers (328) did not find a meaningful difference between the continuous and threshold models in the increase in blood lactate during ramp exercise.

4.2. Clinical applications of the anaerobic threshold. In normal individuals, the AT occurs at about 50–60% $\dot{V}O_2$ max predicted in sedentary individuals, with a wide range of normal values extending from 35 to 80% (112, 113). The AT determination is age, modality, and protocol specific. The AT, when expressed as % $\dot{V}O_2$ max predicted, increases with age (3). The AT is highly modality specific, with arm exercise resulting in lower values versus leg exercise and with cycle ergometry resulting in lower (5–11%) values versus treadmill, a reflection of differences in exercising muscle mass and possibly differences in the dominant fiber type of exercising muscle (203, 204).

The AT demarcates the upper limit of a range of exercise intensities that can be accomplished almost entirely aerobically. Whereas work rates below the AT can be sustained essentially indefinitely, a progressive increase in work rate above AT is associated with a progressive decrease in exercise tolerance (329). Some have postulated that, in patients who become symptom limited with premature cessation of exercise, the AT as an effort-independent measurement may represent a submaximal variable that may assist in clinical decision making (3). Additional validation is necessary.

The AT is reduced in a wide spectrum of clinical conditions/diseases and, as such, has limited discriminatory ability in distinguishing between different clinical entities. A reduction in AT, as in $\dot{V}O_{2peak}$, is somewhat nonspecific, often requiring inspection of other patterns of response to determine the underlying etiology (1, 112) (*see* Section VIII: INTERPRETATION). Values below 40% of predicted $\dot{V}O_2$ max may indicate a cardiac, pulmonary (desaturation), or other limitation in O_2 supply to the tissues, or underlying mitochondrial abnormality (e.g., muscle dysfunction in cardiopulmonary diseases, mitochondrial myopathies, etc.).

AT determination is helpful as an indicator of level of fitness, for exercise prescription, and to monitor the effect of physical training (155, 158). However, if the AT is not reached, as in some patients with severe COPD (161, 330), or cannot be determined from the ventilatory response (160), an exercise prescription can still be established by using as a reference a percentage of peak WR, $\dot{V}O_2$, or HR (22, 153). Similarly, physiologic improvement can be determined by monitoring changes in the variables mentioned above as well as in $\dot{V}E$ and lactate levels (160). Also, in patients undergoing cardiac rehabilitation, despite significant improvements in peak $\dot{V}O_2$ and submaximal/maximal heart rate responses, no significant increase in noninvasively determined AT was noted (64).

4.3. Determination of the anaerobic threshold. Several methods are available for determination of the AT, and include the following: invasive determinations of AT (lactic acid and standard bicarbonate) and noninvasive determinations of AT (ventilatory equivalents method [$\dot{V}E/\dot{V}O_2$, $\dot{V}E/\dot{V}CO_2$, $P_{ET}O_2$, and $P_{ET}CO_2$], V-slope method, and modified V-slope method).

4.3.1. Arterial lactate. Lactic acid accumulation can be described at three levels: intracellular, interstitial, and in blood. The rise in lactate in the blood is most easily detectable. Direct blood sampling is rarely used in the clinical setting, because determination of the point of rise in lactate requires multiple blood samples. When direct blood sampling is used, then the “anaerobic threshold” can be defined as the $\dot{V}O_2$ at which the blood lactate level increases, but the precise definition remains controversial.

Blood samples can be obtained from arterial, capillary, and arterialized venous blood (331–334), with lactate measured in plasma, whole blood, or lysed blood, the latter being preferable (269, 335). Blood samples taken every other minute during exercise usually provide adequate data density for AT determination as long as at least four data points are obtained during exercise (five data points, including the value at rest). The AT is graphically determined by plotting arterial lactate concentration, or $[La^-]$ (mEq/L or mmol/L), against $\dot{V}O_2$. Several mathematical models can be used to assist detection of the lactate threshold (LT): (1) $[La^-]$ is plotted versus $\dot{V}O_2$ in absolute values and lines are “best fitted by eye” to the first and second slopes, using the suspected LT as divider between both slopes. The $\dot{V}O_2$ at which both lines intersect is the AT (*see* Figures 12I and 13I); (2) the logarithm of $[La^-]$ is plotted versus the logarithm of $\dot{V}O_2$ (336). This plot generally provides two straight line segments that more clearly define the slope difference between high and low exercise intensities. The log–log plot can be determined manually or by computerized analysis; and (3) the $[La^-]$ (mmol/L)-to- $\dot{V}O_2$ (L/minute) relationship is fitted to the relationship $[La^-] = a + b[\exp(c\dot{V}O_2)]$, and the LT is identified as the point where the slope is 1.0 (322). This approach requires computerized analysis of the data, but is more objective because it does not require visual inspection for LT determination.

Bishop and coworkers (337) analyzed six conventional and nonconventional descriptors of the AT determined with plasma lactate and its correlation with measurements of performance. Although a significant correlation was observed among the different AT values, a wide range of these values was reported. Work by Tokmakidis and colleagues (using six different mathematical models for the AT determination) (338) failed to demonstrate a unique threshold of the blood lactate concentration curve. Even though the various mathematical models yielded different values for the AT, each correlated well with different indices of performance. Therefore, from a practical point of view it would appear that efforts to define the AT by complex mathematical models are not necessary and that the characteristics of the lactate curve by itself could provide valuable information. Some, however, have raised concerns regarding the curve fits in this work and urged caution in the analysis of these conclusions. These new studies raise questions concerning the necessity of the use of the log $[La^-]$ -versus-log $\dot{V}O_2$ plot as the gold standard for determination of the AT in clinical tests.

4.3.2. Arterial bicarbonate. In situations in which lactate cannot be measured, standard bicarbonate, which is routinely reported with the arterial blood gases, can be used. The same principles and mathematical models employed for the determination of the LT are used for the bicarbonate threshold, with the notable difference that bicarbonate decreases almost reciprocally with lactate increase (319, 339).

Recommendations: When multiple arterial blood samples can be obtained, lactate can be measured to determine the AT, using any of the techniques described herein. Visual inspection of the plot of $[La^-]$ versus $\dot{V}O_2$ is encouraged to verify reliability of the computed AT. The use of arterial bicarbonate for determination of the AT represents an acceptable alternative if lactate cannot be measured.

4.4. Noninvasive determinations. Clinically, increasing lactic acidosis can be determined noninvasively by observing the pattern of change in $\dot{V}CO_2$ and $\dot{V}E$ relative to $\dot{V}O_2$ as exercise intensity increases.

4.4.1. Ventilatory equivalents. The ventilatory equivalents method involves the simultaneous analysis of $\dot{V}E/\dot{V}O_2$, $\dot{V}E/\dot{V}CO_2$, $P_{ET}O_2$, and $P_{ET}CO_2$. The AT is then defined by the following events, all of which occur roughly simultaneously: the $\dot{V}O_2$ at which $\dot{V}E/\dot{V}O_2$ and $P_{ET}O_2$ reach a minimum and thereafter begin to rise

consistently, coinciding with an unchanged \dot{V}_E/\dot{V}_{CO_2} and P_{ETCO_2} (see Figures 11F, 11I, and 12F).

4.4.2. V-Slope. The AT is identified as the \dot{V}_{O_2} at which the change in slope of the relationship of \dot{V}_{CO_2} to \dot{V}_{O_2} occurs (Figure 4). \dot{V}_{CO_2} increases as a relatively linear function of \dot{V}_{O_2} early in an incremental exercise protocol and this slope is termed S_1 . As exercise intensity increases, there is a subsequent increase in the slope, referred to as S_2 . To confirm that this change of slope is not occasioned by hyperventilation, monitoring ventilatory equivalents and end-tidal P_{CO_2} is necessary. Consequently, the ventilatory equivalents for O_2 and end-tidal O_2 reach their nadir and begin to rise in concert with the S_1 - S_2 transition, without an increase in the ventilatory equivalent for CO_2 and/or decrease in end-tidal P_{CO_2} . The V-slope method proposed by Beaver and coworkers (340) is complex (correction for change in CO_2 transport away from the lungs, filtering of the data, and mathematical calculations requiring computerized analysis) and has been replaced in most conventional systems by a simplified approach. The modified V-slope method, in turn, determines the point of the change in slope of the relationship of \dot{V}_{CO_2} versus \dot{V}_{O_2} and defines the \dot{V}_{O_2} above which \dot{V}_{CO_2} increases faster than \dot{V}_{O_2} without hyperventilation (316).

When using these methods to detect anaerobic threshold, it should be kept in mind that there is a good correlation, but not necessarily a firm physiologic link, between ATs determined invasively and noninvasively, and that unusual breathing pattern responses to exercise can adversely impact AT determination (341).

The accuracy of the AT determined by noninvasive methods reported in the literature appears to be related to the investigator's experience, the protocol used, the system utilized for the collection of data, the subjects studied, and the peculiarities and variances of the methods used (318, 319, 342-344). Although the V-slope method is currently the most popular, there appears to be no clear advantage of any one noninvasive method for AT determination (317). Because inappropriate increases in \dot{V}_{CO_2} disproportionate to increases in metabolic rate (\dot{V}_{O_2}) due to acute hyperventilation invalidate the noninvasive determination of the AT, it is recommended that both V-slope and ventilatory equivalents methods be used together ("dual methods approach") as the RER approximates 1.0 to more accurately determine the AT noninvasively (269, 276).

Importantly, the validity of the noninvasively determined AT has not been established in the following clinical settings: chronic hyperventilation, progressive exercise-induced hypoxemia, and patients with COPD who have impaired peripheral chemosensitivity. Blood samples for lactate or standard bicarbonate may be useful and are recommended in these situations as well as those in whom false-positive noninvasive AT determinations have been reported (i.e., COPD) (330).

Recommendation: Noninvasive determination of the AT can be accomplished by using the V-slope method or ventilatory equivalents method or, preferentially, by using both methods (dual methods approach) as RER approximates 1 to minimize errors.

5. Cardiac Output

Cardiac output (Q) increases with exercise to support the increasing metabolic demands of the tissues. The measurement of cardiac output is the best index of cardiac function during exercise. In healthy subjects, Q is a linear function of \dot{V}_{O_2} and does not vary as a function of either sex or state of training.

Cardiac output can be calculated by the Fick equation:

$$\dot{Q} = (SV \times HR) = \dot{V}_{O_2} / [C(a-\bar{v})O_2]$$

where Q indicates cardiac output, SV designates stroke volume,

and $[C(a-\bar{v})O_2]$ indicates the arteriovenous O_2 content difference, which is related to O_2 extraction. The maximal extraction is thought to be about 75% of the arterial oxygen content (Ca_{O_2}) in healthy nonathletic individuals.

Increases in cardiac output are initially accomplished by increases in stroke volume and HR, and then at moderate- to high-intensity exercise almost exclusively by increases in HR. The evaluation of HR response yields an estimation of cardiac function during exercise. The increase in cardiac output is largely driven by vagal withdrawal and by increases in either circulating or neurally produced catecholamines.

Cardiac output is not routinely measured in clinical exercise laboratories; the noninvasive techniques (e.g., CO_2 rebreathing) used to estimate it are technically demanding and the reliability of the results is questionable.

5.1. Heart rate, HR- \dot{V}_{O_2} relationship. In healthy subjects, heart rate increases nearly linearly with increasing \dot{V}_{O_2} . Increases in HR are initially mediated by a decrease in parasympathetic activity (vagal withdrawal) and, subsequently, almost exclusively by increased sympathetic activity. Achievement of age-predicted values for maximal HR during exercise is often used as a reflection of maximal or near maximal effort and presumably signals the achievement of \dot{V}_{O_2max} . However, the use of this marker as a strict exercise end point is not recommended, in agreement with other consensus documents (12, 14). Considerable variability (10 to 15 beats/minute) within an age group is noted when available estimates of maximal HR are used, and as such, may complicate interpretation. The difference between the age-predicted maximal HR and the maximal HR achieved during exercise is referred to as the HR reserve (HRR). Normally, at maximal exercise, there is little or no HRR.

Significant differences in percent predicted maximal heart rate achieved can be observed, depending on the reference equation selected. There are several reference value equations for maximal heart rate; the most widely used are $220 - \text{age}$ (3) and $210 - (\text{age} \times 0.65)$ (345); both give similar values for people younger than 40 years. The first equation appears to underestimate the maximal heart rate in older people (346).

Peak heart rate is reduced in many, but not all, patients with different cardiorespiratory diseases (either because of the disease itself or because of medications used to treat the disease). If a patient reaches his/her predicted maximal HR, this suggests that the patient made a maximal or near maximal effort during exercise and that cardiovascular function may have contributed to exercise limitation (see Section VIII.4: PATTERNS OF EXERCISE RESPONSE IN DIFFERENT CLINICAL ENTITIES).

The HR- \dot{V}_{O_2} relationship is often nonlinear at low work rates for upright exercise, becoming relatively linear as work rate increases to maximum. This relationship can be described by the slope and position of the regression line. The slope of the HR- \dot{V}_{O_2} relationship is a function of the subject's SV: the higher the SV the lower the HR and, typically, its rate of change. HR at a given \dot{V}_{O_2} is higher than normal in patients with lung disease, implying that SV must be lower, because cardiac output is similar to that of normal subjects (347). This may reflect deconditioning or relative unfitnes, ventilatory limitation to exercise, and, possibly, the hemodynamic consequences of dynamic hyperinflation.

Patients with reduced O_2 delivery due to reduced O_2 content (hypoxemia, anemia, carboxyhemoglobin, etc.), patients with abnormal O_2 utilization (metabolic myopathy), as well as patients with deconditioning may also have an upward and steep HR- \dot{V}_{O_2} relationship with (near) attainment of maximal heart rate (see Section VIII.4: PATTERNS OF EXERCISE RESPONSE IN DIFFERENT CLINICAL ENTITIES).

The heart rate response ($\Delta HR/\Delta \dot{V}_{O_2}$), defined as (peak HR-resting HR)/(peak \dot{V}_{O_2} - resting \dot{V}_{O_2}), is another way to evaluate

the relationship between HR and $\dot{V}O_2$. This index has been suggested as an indicator of hyperdynamic cardiovascular response when its value is greater than 50 (348); however, additional validation is required.

Recommendation: Heart rate should be reported along with other variables during incremental testing protocols. A maximal HR that approaches the predicted maximal value suggests achievement of maximal or near maximal patient effort. A reduced maximal heart rate must be interpreted in light of a patient's disease and current medications.

5.2. Oxygen pulse. The ratio of $\dot{V}O_2$ to HR is conventionally termed the "oxygen pulse" and reflects the amount of O_2 extracted per heart beat. The O_2 pulse has been used by some as an estimator of stroke volume during exercise (3, 42). However this remains controversial, especially in patients who desaturate (*see below*). According to the modified Fick equation, the O_2 pulse is numerically equal to the product of SV and the arterial-to-mixed venous O_2 content difference, $C(a-\bar{v})O_2$.

$$\dot{V}O_2/HR = SV \times C(a-\bar{v})O_2$$

The profile of the O_2 pulse response during exercise therefore reflects the product of these two variables. The O_2 pulse normally increases with incremental exercise because of increases in both SV and O_2 extraction. At a near maximal/maximal work rate, in which $C(a-\bar{v})O_2$ is assumed to be maximal and relatively constant, the pattern of change of the O_2 pulse will represent the concomitant pattern of change of the SV as long as the previous assumption is correct. The basic profile of the O_2 pulse over the range in which $\dot{V}O_2$ increases linearly with HR appears to be hyperbolic, with a rapid rise at low work rates followed by a slow approach to an asymptotic value. A low, unchanging, flat O_2 pulse with increasing work rate may therefore be interpreted as resulting from a reduced SV and/or as a failure for further skeletal muscle O_2 extraction. A low O_2 pulse therefore may reflect deconditioning, cardiovascular disease, and early exercise limitation due to ventilatory constraint or symptoms. Consequently, caution should be exercised in interpreting changes in O_2 pulse response solely as an index of cardiovascular dysfunction.

There are several mathematical models that have been developed in an attempt to more accurately estimate SV from the $\dot{V}O_2$ -HR relationship. Work with normal subjects has suggested that the "asymptotic O_2 pulse," which is the product of $1/Ca_{O_2}$ and the slope of the $\dot{V}O_2$ -HR relationship rather than the maximal O_2 pulse achieved, may provide a more reliable estimator of the average SV during incremental exercise in normal subjects (349). Although theoretically attractive and applicable in normal subjects, validation in patients is necessary, especially in subjects in whom Ca_{O_2} might be expected to change during exercise (*i.e.*, patients with lung disease) or for whom the assumption of linearity between cardiac output and $\dot{V}O_2$ may not reasonably be made, as in patients with cardiovascular disease.

Stringer and coworkers (350), using a linear regression equation to calculate $C(a-\bar{v})O_2$ at a given $\dot{V}O_2$ during incremental exercise in normal subjects, computed stroke volume according to the Fick equation. Calculated and measured stroke volume were comparable in normal subjects. Likewise, this method requires validation in patients. Agostoni and coworkers (351) calculated the stroke volume in patients with congestive heart failure, using a fixed value for $C(a-\bar{v})O_2$. Good agreement was noted between calculated and measured stroke volume; the best correlation occurred with measurements made at the AT. These data require corroboration. Another concept that has appeared in the literature, which requires validation, is the "extended O_2 pulse" (352), which corresponds to the O_2 pulse calculated from the extrapolation of the slope of the measured HR to the predicted $\dot{V}O_2$.

6. Blood Pressure Response

As exercise intensity increases, reflex control of distribution of cardiac output causes some characteristic changes in blood pressure and vascular resistance (9). In working muscle, there are local mediators that cause intense vasodilation that increases blood flow to support metabolic demands. In addition, nonworking muscles are vasoconstricted from reflex increases in sympathetic nerve activity. The net result is a fall in systemic vascular resistance, but systolic blood pressure typically rises progressively with an increase in $\dot{V}O_2$. Diastolic blood pressure typically remains constant or may decline slightly if left heart function keeps up with the increases in cardiac output (*see* Table 17). Abnormal patterns of blood pressure response include reduced rise, excessive rise, or a fall. An excessive rise in blood pressure is often seen in patients with known resting hypertension, but an abnormal rise with exercise in the face of normal resting blood pressure is also indicative of abnormal blood pressure control. If blood pressure does not increase with exercise, or in fact declines, a cardiac limitation or abnormality of sympathetic control of blood pressure is strongly suggested. If blood pressure falls as exercise intensity increases, the exercise test should be terminated immediately (Table 9), as such a response could indicate serious abnormality such as heart failure, ischemia, or restriction to blood flow such as aortic stenosis, pulmonary vascular disease, or central venous obstruction

7. Ventilation

Increased ventilation (\dot{V}_E) during exercise is one of the primary means by which arterial blood regulates gases and acid-base status under conditions of the augmented metabolic demands of exercising muscles. Although the mechanisms that couple \dot{V}_E to gas exchange (metabolic demands) during exercise are not completely understood, several indicators of the ventilatory response to exercise may assess the normalcy or adequacy of the ventilatory response.

The most common ventilatory indices assessed during exercise include changes in total minute ventilation (\dot{V}_E) and breathing pattern (tidal volume, V_T , and respiratory frequency, f_R) along with assessment of ventilatory reserve. Less commonly evaluated are changes in ventilatory timing (inspiratory time, T_I , expiratory time, T_E , and total time, T_{tot}) and changes in tidal volume relative to specific lung volumes (*e.g.*, V_T/VC). More recently, changes in inspiratory capacity (IC) and a more thorough assessment of ventilatory constraint to exercise have also been utilized (288). Because ventilation is a balance between optimization of the mechanics of breathing and maintenance of gas exchange, many of the ventilatory indices express these combined elements, such as the efficiency of ventilation (\dot{V}_E versus $\dot{V}O_2$ or $\dot{V}CO_2$) (*see* Section IV,10: PULMONARY GAS EXCHANGE).

7.1. Breathing pattern and ventilatory timing. The rise in \dot{V}_E with exercise is associated with an increase in both depth and frequency of breathing. In health, increases in tidal volume are primarily responsible for increases in ventilation during low levels of exercise (353, 354). As exercise progresses, both V_T and f_R increase until 70 to 80% of peak exercise; thereafter f_R predominates (309, 353). V_T usually plateaus at 50 to 60% of vital capacity (VC); however there is considerable variation (355). Younger adults typically increase V_T by three- to fivefold whereas in older adults V_T tends to increase less (two- to fourfold) (356). Breathing frequency typically increases one- to threefold in most subjects, but in fitter athletes it may be increased by six- to sevenfold at high levels of \dot{V}_E . In some subjects at extremely high ventilatory demands, V_T actually decreases as f_R increases (357).

In health, the increase in V_T is due to both a decrease in end-expiratory lung volume (EELV) through encroachment on the expiratory reserve volume but predominantly to an increase in end-inspiratory lung volume (EILV) through a decrease in the inspiratory reserve volume (358). With progressive increases in exercise intensity and \dot{V}_E , EELV continues to fall to 0.5–1.0 L below the resting FRC (358). It has been hypothesized that the fall in EELV optimizes inspiratory muscle length (for force development) and helps prevent too large an increase in EILV, which would increase the inspiratory elastic load of breathing (359). In addition, the energy stored in the abdominal wall because of active expiration may provide some passive recoil at the initiation of the ensuing inspiration (360).

The increase in f_r with exercise reflects a decrease in both inspiratory time (T_I) and expiratory time (T_E). Typically, however, at the moderate to higher ventilatory demands, a greater fractional decrease is noted in T_E so that T_I/T_{tot} increases from 0.4 at rest to 0.5 to 0.55 at maximal exercise (361, 362). Because of the greater decrease in T_E , the increase in mean expiratory flow rate is greater than the increase in mean inspiratory flow rate.

7.2. Ventilatory reserve/capacity. Whether ventilatory limitation causes or contributes to exercise intolerance has traditionally been evaluated by the ventilatory reserve, which reflects the relationship of ventilatory demand to ventilatory capacity. In most healthy adults, peak exercise ventilation approaches 70% of the MVV (\dot{V}_E reserve typically greater than 15% of the MVV), although this percentile increases with increased fitness and with normal aging.

7.2.1. Ventilatory demand. Ventilatory demand is dependent on multiple factors including metabolic requirement, degree of lactic acidosis, dead space ventilation, behavioral factors, deconditioning, body weight, mode of testing (e.g., arm versus leg exercise), and additional factors involved in ventilatory control.

Physiologic factors associated with the level of ventilation are linked through the following equation:

$$\dot{V}_E = [863 \times \dot{V}_{CO_2}] / [P_{aCO_2}(1 - V_D/V_T)]$$

where 863 is the constant that corrects for the different conditions of reporting the gas volumes (for a body temperature of 37°C) and also the transformation of fractional concentration to partial pressure. \dot{V}_{CO_2} (STPD) and \dot{V}_E (BTPS) are in liters per minute. P_{aCO_2} is in millimeters of mercury. V_D/V_T is expressed as a fraction. From the above equation, it is apparent that the ventilatory demand for a given work rate can be different depending on the current values of these defining variables. The ventilatory demand is usually increased at rest and at any given level of exercise in patients with COPD, ILD, and pulmonary vascular disease (PVD) due to ventilation–perfusion (\dot{V}/\dot{Q}) inequality with increased V_D/V_T , hypoxemia, and probably increased stimulation of lung receptors (which drive ventilation and reduce P_{aCO_2}).

7.2.2. Ventilatory capacity. One challenging task in evaluation of the ventilatory response is the determination of maximal ventilatory capacity, which corresponds to the theoretical maximal ventilation that the respiratory system can attain. Mechanical factors, ventilatory muscle function, genetic endowment, aging, and disease affect the ventilatory capacity. Ventilatory capacity may also vary during exercise because of bronchodilation or bronchoconstriction and is dependent on the lung volume, where tidal breathing occurs relative to total lung capacity and residual volume (i.e., the regulation of end-inspiratory and end-expiratory lung volume, EILV and EELV, respectively). In the latter case, breathing at a low lung volume (near residual volume) limits the available ventilatory reserve due to the shape of the expiratory flow–volume curve and the reduced maximal avail-

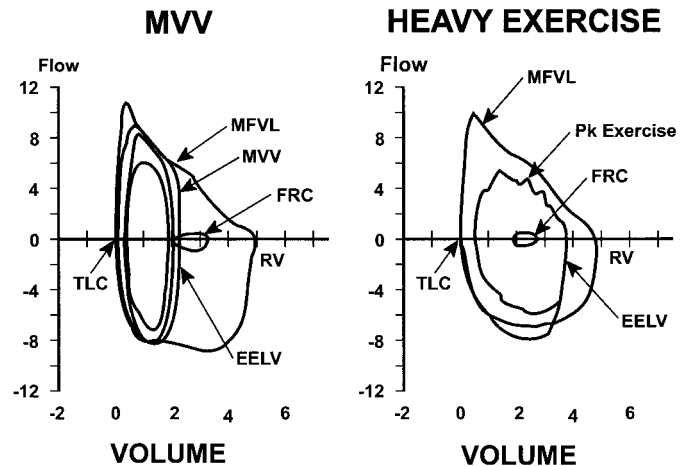

Figure 5. Comparison of the flow–volume loops obtained during an MVV maneuver (left) and near maximal incremental exercise (right), in the same normal individual. The MVV is performed at high lung volumes and EELV is increased. In contrast, during exercise, EELV is reduced, resulting in tidal breathing occurring at a more optimal position of the pressure–volume relationship with consequent less work of breathing (modified from Johnson and coworkers [288]). EELV = end-expiratory lung volume; FRC = functional residual capacity; MFVL = maximal flow–volume loop; MVV = maximal voluntary ventilation; Pk = peak; RV = residual volume.

able airflow as well as a reduced chest wall compliance. Conversely, breathing at high lung volumes (near total lung capacity) increases the inspiratory elastic load and therefore the work of breathing (see Section IV,8: EMERGING TECHNIQUES TO EVALUATE VENTILATORY LIMITATION).

Traditionally, the ventilatory capacity is represented by the maximal voluntary ventilation (MVV). However, the use of MVV has many shortcomings:

- It depends on volitional effort with consequent concerns for reproducibility (17).
- The breathing strategy during MVV is different from that observed during exercise: Figure 5 illustrates the flow–volume loops obtained while a subject performs the typical 12- to 15-second MVV maneuver versus the same subject exercising at near maximal capacity: neither breath timing nor volume is replicated; end-expiratory lung volume (EELV) is typically higher during the MVV (breathing is performed at high lung volumes) than during exercise (288); and excessive expiratory effort and pressure are exerted during the MVV and typically are not during exercise. In this regard, the work of breathing associated with the MVV maneuver greatly exceeded that achieved when the hyperpnea is reflexly driven as occurs during exercise (363).
- The MVV cannot be sustained for more than 15 to 20 seconds, making its relevance for exercise of more than this time duration questionable.
- The MVV test conducted before exercise does not take into account factors such as the bronchodilation of exercise.

Alternatively, some investigators prefer calculating, rather than directly measuring, the $FEV_{1,1}$. The $FEV_{1,1}$, which can be standardized and reproduced, is multiplied by an appropriate factor (35 to 40). MVVs estimated by this method were, on average, not discernibly different from MVVs directly measured in patients with COPD (39, 235, 364). However, the calculated MVV may not be as appropriate for patients with predominantly

inspiratory resistance increases (e.g., vocal cord dysfunction or soft tissue tumors of the neck) or for patients with neuromuscular disorders, extreme obesity, or respiratory muscle weakness (e.g., heart failure). The inspiratory load or muscle weakness may result in a marked fall in the actual MVV over the 12- to 15-second time period and thus the predicted MVV from a single maneuver would overestimate the true breathing capacity (365–367).

Despite these concerns, the MVV has been shown to correlate highly with the maximal attainable ventilation during exercise in patients with COPD (3, 30). It provides a general (although variable) approximation of ventilatory capacity. The MVV is readily and widely applied, is conceptually easily understood, and requires minimal analysis. The large body of literature available with its use (including normal reference values) and the fact that it has not, to date, been supplanted by an alternative test with the requisite ease of performance, validity, and reproducibility permit its continued use.

7.3. Ventilatory reserve. Ventilatory reserve determination corresponds to how close the peak minute ventilation (ventilatory demand) achieved during exercise ($\dot{V}_{E\max}$) approaches the MVV (ventilatory capacity) or some estimate of the MVV ($FEV_1 \times 35\text{--}40$). Traditionally, ventilatory “reserve” (3) has been defined as the percentage of MVV achieved at peak exercise [$(\dot{V}_{E\text{peak}}/\text{MVV}) \times 100$] or, alternatively, as the difference between MVV and the \dot{V}_E achieved at peak exercise. However, the “normal” values for this index standard have a high variance. And although the values can vary by up to 50% in normal subjects, a lower limit of a 15% difference between \dot{V}_E and MVV appears to be a reasonable reserve, based on 95% confidence limits of normative data. The value is not independent of fitness or aging, as the reserve is less in both fit and aged normal subjects. Patients with pulmonary diseases characteristically have reduced ventilatory capacity and increased ventilatory demand, resulting in reduced ventilatory reserve.

7.4. Relationship of \dot{V}_E versus $\dot{V}O_2$ and of \dot{V}_E versus $\dot{V}CO_2$. Analysis of the \dot{V}_E – $\dot{V}O_2$ relationship during incremental exercise enables a graphic overview and appreciation of important ventilatory trending patterns related to the appropriateness of the ventilatory response to metabolic demands. Physiologically, the \dot{V}_E – $\dot{V}O_2$ relationship would be the better option to analyze the ventilatory response to metabolic needs because, although \dot{V}_E varies with $\dot{V}O_2$, $\dot{V}O_2$ is nearly independent of \dot{V}_E . However, the relationship between \dot{V}_E and $\dot{V}O_2$ is complex, commonly nonlinear, and difficult to standardize. Abnormal ventilatory response patterns including excessive ventilation due to hyperventilation or increased dead space, periodic breathing, or erratic or other psychogenic abnormalities may also be revealed (see Section VIII: INTERPRETATION).

Others prefer plotting \dot{V}_E versus $\dot{V}CO_2$, as ventilation is so closely linked to CO_2 production. However, because $\dot{V}CO_2$ is dependent on \dot{V}_E , some have suggested that it would be inappropriate for it to be used as the reference variable. \dot{V}_E correlates closely with $\dot{V}CO_2$ during moderate exercise, whether incremental or constant-load (see Figure 11D). In healthy subjects the \dot{V}_E – $\dot{V}CO_2$ relationship is linear, with an intercept on the \dot{V}_E axis of some 4–5 L/minute. The slope of this relationship reflects that in normal subjects 23–25 L of \dot{V}_E is required to eliminate 1 L of CO_2 . The slope can be appreciably higher when V_D/V_T is high (368) or when the “set point” for arterial P_{CO_2} is low. The incorporation of the MVV value into the graph permits visual inspection of the ventilatory reserve; approaching or exceeding this limit indicates that there is little or no ventilatory reserve (see Figure 9D). Currently, either a plot of \dot{V}_E versus $\dot{V}CO_2$ or a plot of \dot{V}_E versus $\dot{V}O_2$ is acceptable for the graphic representation of ventilatory data.

7.5. Ventilatory equivalent for $\dot{V}O_2$ and $\dot{V}CO_2$. The ratio of \dot{V}_E to $\dot{V}O_2$ is called the ventilatory equivalent for O_2 and the ratio of \dot{V}_E to $\dot{V}CO_2$ is called the ventilatory equivalent for CO_2 . The ventilatory equivalents for O_2 and CO_2 are both related to V_D/V_T , being higher as V_D/V_T increases. However, the ventilatory equivalents also increase with hyperventilation, and therefore interpretation must be made carefully. Because the relationships of \dot{V}_E versus $\dot{V}O_2$ and of \dot{V}_E versus $\dot{V}CO_2$ have a positive intercept on the \dot{V}_E axis, a graph of the ventilatory equivalents versus work rate or $\dot{V}O_2$ decreases hyperbolically at low work rates. For a more detailed explanation of the contour of the ventilatory equivalents versus $\dot{V}O_2$ the interested reader is referred to other sources (113). The normal pattern of change in $\dot{V}_E/\dot{V}O_2$ is a drop early in exercise to its nadir near the AT, and then an increase as maximal exercise capacity is approached. The ventilatory equivalent for CO_2 also decreases hyperbolically as work rate increases. For incremental tests, the increase in $\dot{V}_E/\dot{V}O_2$ that typically occurs in concert with the development of metabolic acidemia occurs at a time when $\dot{V}_E/\dot{V}CO_2$ has not yet increased (see Figure 11F). It is this profile that separates this response from the onset of hyperventilation from other causes (e.g., anxiety, pain, or hypoxemia), in which case both $\dot{V}_E/\dot{V}O_2$ and $\dot{V}_E/\dot{V}CO_2$ would increase in concert. The normal subsequent increase in $\dot{V}_E/\dot{V}CO_2$ reflects the onset of frank compensatory hyperventilation for metabolic acidosis, with concomitant reduction in P_{aCO_2} and typically P_{ETCO_2} . The mean of the minimal $\dot{V}_E/\dot{V}CO_2$ is about 25 in healthy young subjects, but may exceed 30 in older individuals. Usually $\dot{V}_E/\dot{V}CO_2$ is less than 32–34 at or near the AT and less than 36 (rarely 40) at peak exercise in normal subjects. $\dot{V}_E/\dot{V}O_2$ also decreases to minimal values similar to or slightly greater than that for $\dot{V}_E/\dot{V}CO_2$. High $\dot{V}_E/\dot{V}CO_2$ at its nadir suggests a high V_D/V_T or a low P_{aCO_2} . Lack of a subsequent increase in $\dot{V}_E/\dot{V}O_2$ or $\dot{V}_E/\dot{V}CO_2$ reflects either insensitivity to the stimuli associated with metabolic acidosis or the presence of high airway resistance or a general increase in respiratory muscle load. This may be observed in some patients with COPD who are clearly ventilatory limited but able to exert themselves so that P_{aCO_2} begins to rise, indicating an inadequate ventilatory response (369). Similarly, in morbid obesity, some subjects may not ventilate adequately for the metabolic load and $\dot{V}_E/\dot{V}CO_2$ will remain low (370).

7.6. End-tidal P_{O_2} and P_{CO_2} . P_{ETCO_2} increases and P_{ETO_2} decreases throughout the moderate work rate range. P_{ETO_2} typically begins to increase in concert with the increase in $\dot{V}_E/\dot{V}O_2$ during incremental tests (see Figure 11I). With the increasing work rate, P_{ETCO_2} typically increases (although P_{aO_2} does not) until the subsequent increase in $\dot{V}_E/\dot{V}O_2$ occurs, at which time P_{ETCO_2} stabilizes until the subsequent increase in $\dot{V}_E/\dot{V}CO_2$ occurs; then P_{ETCO_2} starts to fall concomitantly with the increase in P_{ETO_2} . The period of increasing P_{ETO_2} with relatively stable P_{ETCO_2} has been termed “isocapnic buffering” (371). A fall in P_{ETCO_2} when $\dot{V}_E/\dot{V}CO_2$ is high suggests hyperventilation whereas high $\dot{V}_E/\dot{V}CO_2$ without a fall in P_{ETCO_2} suggests increased dead space ventilation.

8. Emerging Techniques to Evaluate Ventilatory Limitation

In an effort to assess more thoroughly the source and degree of ventilatory constraint, additional indices have been used (372). One technique involves the plotting of exercise tidal flow–volume loops (extFVLs) within the maximal flow–volume loop (MFVL), which provides a unique visual index of “ventilatory demand” versus “ventilatory capacity.” This, of course, is critically dependent on the accurate placement of the exercise tidal flow–volume loop within the MFVL. Noting how much of the tidal volume encroaches on the expiratory limb of the flow–volume envelope can identify the amount of expiratory flow limitation. In normal, young subjects, this rarely occurs except perhaps near maximal exercise and near the end of a tidal breath,

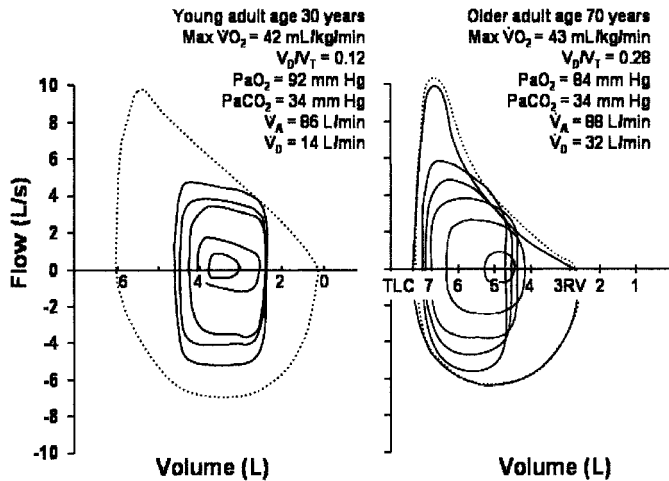

Figure 6. Flow–volume responses to exercise in younger (left) and older (right) adults. Subjects were matched for similar peak $\dot{V}O_2$ values. Key differences in the ventilatory response to exercise: *Young adult:* (1) drop in FRC, (2) encroachment equally on IRV and ERV, (3) little or no expiratory flow limitation, (4) available inspiratory flow reserve, and (5) significant volume reserve. *Older adult:* (1) drop in FRC followed by an increase with flow limitation, (2) encroachment mostly on IRV, (3) significant expiratory flow limitation, (4) minimal inspiratory flow reserve, (5) little reserve to increase either flow or volume at peak exercise. It should be noted that the young adults had average levels of fitness, whereas the older adults studied were much fitter than predicted for age ($\dot{V}O_{2,max}$ approximately twice the age-predicted value) (368). ERV = expiratory reserve volume; FRV = functional residual volume; IRV = inspiratory reserve volume.

near the EELV (368, 373) (Figure 6, left). In an older normal subject, expiratory flow limitation may begin to occur with only moderate exercise because of the reduced elastic recoil and the consequent “scooping” of the MFVL (Figure 6, right). When the tidal inspiratory flow rates meet the boundary of the maximal inspiratory flow–volume loop, this is a clear sign that the ability of the inspiratory muscles to generate pressure and flow is reaching capacity. Increases in the end-expiratory lung volume (dynamic hyperinflation) are also important. End-expiratory lung volume (Figure 5, right) normally falls with increasing work rate (288, 374) (see Section IV,7.1: BREATHING PATTERN AND VENTILATORY TIMING). However, in those subjects who begin to develop significant expiratory flow limitation, EELV typically begins to rise (72, 288, 372, 374, 375) as work rate and ventilatory requirements increase further. In a patient with moderate COPD and average age-related fitness, EELV increases with the onset of exercise and is constrained by significant expiratory flow limitation and an EILV that approaches TLC (Figure 7). Although variable, when the end-inspiratory lung volume increases to values approaching the TLC (e.g., 90% TLC), this suggests an increasing elastic load to breathing. Although the use of the exercise flow–volume loop analysis is gaining popularity as a means of quantifying ventilatory constraint (72, 288, 372, 376), it remains technically more involved than traditional estimates and its clinical utility requires further study.

8.1. Maximal exercise ventilation: \dot{V}_{Ecap} . Additional methods have evolved in an attempt to better identify the “true” ventilatory capacity available for producing ventilation during exercise. Analysis of the exercise tidal flow–volume loop during exercise plotted within the maximal flow–volume envelope enables a theoretical estimation of this “true” ventilatory capacity (\dot{V}_{Ecap}) (377, 378). By taking into consideration the patient’s

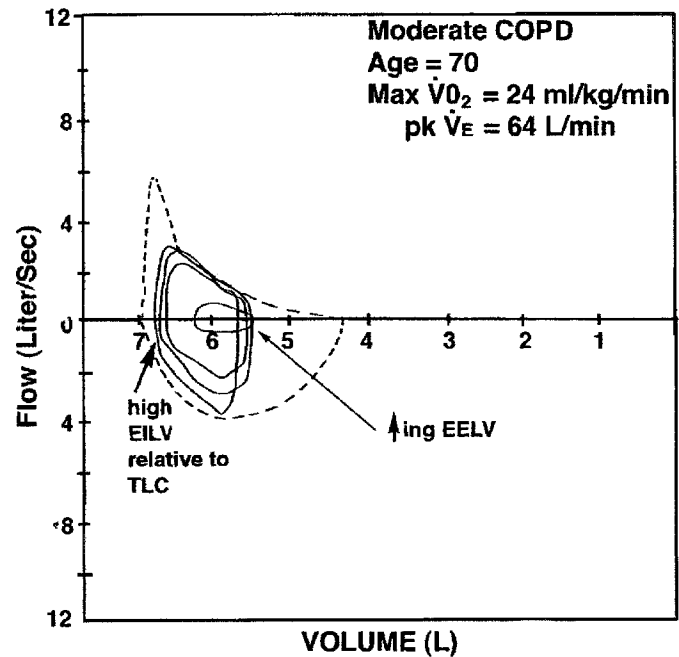

Figure 7. Patient with history of moderate COPD (forced expiratory flow at 50% of VC = 35% of value predicted for age): EELV increases from the onset of exercise and expiratory flow limitation is present over more than 80% of the V_T by peak exercise. Inspiratory flows approach those available over the higher lung volumes. Little room exists to increase ventilation (288). EELV = End-expiratory lung volume; EILV = end-inspiratory lung volume; TLC = total lung capacity.

breathing strategy (tidal volume), operational lung volume (EELV), and exercise-induced changes in airway tone (MFVL performed during exercise), maximal available ventilation can be determined. It has been reported that \dot{V}_{Ecap} was similar to measured MVV in normal individuals (377).

8.2. Negative expiratory pressure. A more direct and, in principle, simple means for testing whether expiratory flow limitation has, in fact, occurred has been described by Kolouris and coworkers (379, 380). In this test, a small negative pressure is applied at the mouth at the initiation of tidal expiration. A lack of increase in expiratory flow over that seen during spontaneous breathing suggests expiratory flow limitation. This type of technique offers theoretical advantages over the use of the exercise tidal flow–volume loop method in that it is not dependent on an accurate assessment of the MFVL or on accurate placement of the tidal flow–volume loops by assessment of IC. Clearly, however, flow limitation is volume dependent, typically beginning at low lung volume near EELV and gradually increasing along with the tidal breath until either hyperinflation occurs or ventilation is fully constrained. A limitation to the use of negative expiratory pressure is that the method may demonstrate an increase in expiratory flow early in expiration, suggesting no flow limitation, when in fact flow may be limited at the lower lung volumes. This technique only allows for evaluation of the presence or absence of flow limitation, and flow limitation is not an all-or-none phenomenon (372). In addition, no information about operational lung volumes and, in turn, breathing strategy is provided. However, the negative expiratory pressure technique combined with an assessment of the extFVL may yield the most accurate assessment of the degree of expiratory flow limitation as well as other indices of constraint. Further study and validation of this technique are required.

Other techniques that have also been applied to assess the degree of ventilatory constraint (limitation) during exercise include the following: breathing through an increased dead space volume (378), hypercapnic stimulation (309, 381, 382), and heliox administration (377, 383–386). However, these techniques also provide little information about breathing strategy and, apart from the negative pressure technique, tell little about the specific source of ventilatory constraint and still remain in the domain of research laboratories.

9. Respiratory Muscle Evaluation

The maximal inspiratory and expiratory pressures determined at residual volume or at FRC and at TLC, respectively, are commonly used as indices to assess whether respiratory muscle weakness may play a role in ventilatory limitation during exercise. They provide a general idea of whether the inspiratory or expiratory muscles are capable of generating “normal” pressures and normative data have been published for different age ranges. Despite fairly widespread use, there are limitations associated with these measurements.

- They are static measurements that do not take velocity of muscle shortening into account.
- They are highly volitionally dependent, with a significant learning curve.
- They are critically dependent on lung volume and muscle length.

The more widely accepted lower limits of normal for maximal inspiratory pressure measured at RV are as follows: 75 cm H₂O for men and 50 cm H₂O for women. The lower limits for maximal expiratory pressure measured at TLC are as follows: 100 cm H₂O for men and 80 cm H₂O for women (387). An ATS/ERS statement on Respiratory Muscle Testing has been published (388).

Endurance tests of respiratory muscle function, such as the maximal sustainable voluntary ventilation to task failure, are highly dependent on the breathing cycle selected and on volitional effort. Given these considerations, it has been suggested that the inspiratory limb of the tidal flow–volume loop obtained during exercise, relative to the maximal inspiratory flows obtained before exercise at rest, may provide the best estimate of the relationship between inspiratory muscle function during exercise and maximal inspiratory muscle capacity (381, 389).

10. Pulmonary Gas Exchange

Efficient pulmonary gas exchange function is important to a normal exercise response (390). A number of indices can be used to monitor changes in lung gas exchange, including the alveolar–arterial Po₂ pressure difference [P(A–a)O₂], PaO₂, physiologic dead space-to-tidal volume ratio (V_D/V_T), and PaCO₂. The ventilatory equivalents for O₂ and CO₂, and end-tidal Po₂ and Pco₂, are also used as noninvasive estimators of gas exchange (see above).

10.1. Alveolar–arterial Po₂ pressure difference and PaO₂. An important index of abnormality in pulmonary gas exchange is the alveolar-to-arterial oxygen tension difference. The alveolar–arterial Po₂ difference measures the difference between the “ideal” alveolar Po₂ and arterial Po₂. Alveolar gas composition varies from one breath to another and in different alveoli. These normal biologic variations may be significantly larger in patients with cardiopulmonary disease.

The equation used for calculation of the ideal PA_{O₂} by indirect means is based on the assumption that the PaCO₂ is representative of the mean Pco₂ in all the perfused alveoli and that the respiratory exchange ratio (RER, or R) for these alveoli is equal to that of the lungs as a whole. The ideal PA_{O₂} represents what the

alveolar Po₂ of the whole lung would be if the composition of gases were homogeneous throughout the lungs. When CO₂ is absent in the inspired gas, alveolar Po₂ is computed from the alveolar gas equation (391–393):

$$PA_{O_2} = PI_{O_2} - PA_{CO_2}/R + [PA_{CO_2} \times FI_{O_2} \times (1 - R)/R]$$

A simplified version of this equation, in which PA_{CO₂} is replaced with Pa_{CO₂}, is the most commonly used:

$$PA_{O_2} = PI_{O_2} - \frac{Pa_{CO_2}}{R}$$

In these equations R is the respiratory exchange ratio measured from expired gas, and PA_{CO₂} is the ideal alveolar Pco₂ (defined as the PA_{CO₂} of a mythical, perfectly homogeneous lung with the same R value as the lung under study) and is assumed to equal Pa_{CO₂}. PI_{O₂} is determined by the barometric pressure and fraction of inspired O₂, (PB – 47) × FI_{O₂} (25). Because the term in square brackets in these equations normally contributes only 2 mm Hg or less to the estimated PA_{O₂} and becomes inconsequential when R = 1.0, in clinical practice it is commonly neglected.

P(A–a)O₂ is then simply (PI_{O₂} – PaCO₂/R) – PaO₂, where PaO₂ is the arterial Po₂ sampled concurrently with the measurement of R. It is common in clinical practice to assign a fixed value of 0.8 to R (when not actually measured) to calculate P(A–a)O₂ at rest; however, this value needs to be evaluated cautiously and used only as a rough estimate because the impact of R in the equation is significant. If the real R value for the patient is 1.0 the error in the estimate would be about 10 mm Hg. Real data contain random errors that, collectively, can have a large effect on P(A–a)O₂. It is important to recognize that, even when the true P(A–a)O₂ is normal (about 6 mm Hg at rest), the measured value may be calculated as negative because of the additive effects of acceptable error levels of the primary variables (394). This, of course, will be less likely during exercise, as P(A–a)O₂ increases (190).

The P(A–a)O₂ is helpful in determining (although only partially) the cause of a drop in PaO₂ with exercise. Thus, if alveolar Po₂ falls as much as arterial Po₂ [normal P(A–a)O₂], the hypoxemia is essentially due to an inadequate ventilatory response to exercise (relative alveolar hypoventilation for the work rate) and, as a consequence, a concomitant increase in PaCO₂ should occur. This could be due to mechanical derangement of the lungs and/or chest wall or to respiratory muscle fatigue or inadequate respiratory control mechanisms. The other cause of a drop in PaO₂ without a change in P(A–a)O₂ is in a hypoxic environment (altitude, with reduced PB, or reduced inspired O₂ fraction) (395).

If PaO₂ falls without a drop in PA_{O₂} [increased P(A–a)O₂], other mechanisms must be present. These could include (1) worsening V/Q inequalities, (2) increasing right-to-left shunt, (3) alveolar–capillary diffusion limitation, and (4) a compounding of the first three factors by the inevitable fall in mixed venous Po₂ that occurs between rest and exercise (396). Mixed venous Po₂ falls simply because the relative increase in O₂ uptake exceeds that of cardiac output, with an obligatory rise in arterial–venous [O₂] difference and thus a fall in mixed venous [O₂]. Other things being equal, a lower mixed venous [O₂] will (1) reduce end-capillary Po₂ in exchanging units of all V/Q ratios, (2) worsen the arterial hypoxemia due to shunting, and (3) prolong the time required for full oxygenation of capillary blood by diffusion (397).

Responses of P(A–a)O₂ and PaO₂ to exercise. Conventionally, the measurement of P(A–a)O₂ during exercise has been performed under steady state conditions. Currently, however, this measurement is being done during non-steady-state incremental and ramp exercise protocols in which gas exchange variables are measured in a breath-by-breath mode. Similar results have been

reported between measurements obtained at comparable levels of \dot{V}_{O_2} during incremental and constant work exercise (275, 398).

In normal individuals, $P_{(A-a)O_2}$ increases during exercise because of a combination of factors, including \dot{V}/\dot{Q} mismatching, O_2 diffusion limitation, and low mixed venous O_2 (390). In turn, Pa_{O_2} usually remains the same despite the increase in \dot{V}_{O_2} (210). However, a significant decrease in Pa_{O_2} at maximal exercise has been reported in a large percentage of endurance-trained athletes (396, 399). In another study of physically active but non-endurance-trained healthy young soldiers, a spectrum of response of Pa_{O_2} (i.e., increase, no change, or decrease) to incremental exercise was observed (400). The dependence of Pa_{O_2} and $P_{(A-a)O_2}$ on age (3, 401), PI_{O_2} (6, 402), and exercise modality (403) is emphasized. To interpret the Pa_{O_2} response to exercise, it is important to consider the magnitude of the drop, physical condition of the individual, and at what percentage of $\dot{V}_{O_2,max}$ the reduction of Pa_{O_2} occurs.

$P_{(A-a)O_2}$ is normally less than 10 mm Hg at rest, but may increase to more than 20 mm Hg during exercise, even in normal individuals with no history of lung disease. Values greater than 35 mm Hg indicate possible gas exchange abnormality, and values greater than 50 mm Hg indicate likely pulmonary abnormality, although limits of abnormality are not firmly established.

10.2. Physiologic dead space-to-tidal volume ratio: V_D/V_T . Another index of gas exchange efficiency is V_D/V_T , the ratio of physiologic dead space to tidal volume. V_D/V_T can also be described as the fraction of each breath that would hypothetically be “wasted” on ventilating both the anatomic dead space and the alveoli that are unperfused by blood (physiologic dead space). An increase in V_D/V_T reflects an increased inefficiency of ventilation (ventilation-perfusion [\dot{V}/\dot{Q}] mismatching or right-to-left shunt) and, as a consequence, requires an increase in \dot{V}_E to maintain Pa_{CO_2} . However, the increase in \dot{V}_E may be inadequate to compensate for the increased V_D/V_T and Pa_{CO_2} levels may rise depending on factors related to control of breathing and the degree of ventilatory constraint (404). V_D/V_T measurement is also highly dependent on the breathing pattern, that is, rapid shallow breathing increases V_D/V_T even without abnormalities of \dot{V}/\dot{Q} (405, 406).

V_D/V_T is measured from arterial PCO_2 , and $P\bar{E}_{CO_2}$, using the following equation (407):

$$V_D/V_T = (Pa_{CO_2} - P\bar{E}_{CO_2})/Pa_{CO_2}$$

$P\bar{E}_{CO_2}$ represents the mixed expired value of alveolar and dead space gas, in millimeters of mercury. $P\bar{E}_{CO_2}$ can be measured directly by collecting expired gas in a large gas-impermeable bag over time and measuring the PCO_2 of the gas in the bag. Modern commercial exercise systems provide this value either by sampling gas from a mixing chamber, or, for breath-by-breath systems, by determining the \dot{V}_{CO_2}/\dot{V}_E ratio, where both gas volumes are expressed in liters (STPD).

Because most exercise is accomplished with subjects connected to a mouthpiece and frequently to a nonbreathing valve, the equation needs to be modified to incorporate the mouthpiece and valve dead space (30–110 ml):

$$V_D/V_T = [(Pa_{CO_2} - P\bar{E}_{CO_2})/Pa_{CO_2}] - (V_{Dvalve}/V_T)$$

There are no valid procedures that allow Pa_{CO_2} to be adequately estimated noninvasively, especially in patients with lung disease. End-tidal PCO_2 (P_{ETCO_2}) should not be used as an index of Pa_{CO_2} ; indeed, this can be misleading, as it can exceed Pa_{CO_2} (272, 273). Normally, the P_{ETCO_2} is slightly less than Pa_{CO_2} at rest, but P_{ETCO_2} becomes greater than Pa_{CO_2} with exercise in normal individuals. This would lead to an overestimation of V_D/V_T . In lung disease, however, because of effects of lung regions with increased $\dot{V}_A/$

\dot{Q} , P_{ETCO_2} may remain below Pa_{CO_2} even during exercise, possibly leading to an underestimation of V_D/V_T (3).

V_D/V_T response to exercise. During exercise, several partly independent events may alter V_D/V_T . First, the increased tidal volume with exercise induces radial traction on the conducting airways by the surrounding parenchyma, enlarging the intrapulmonary airway volume (408). Second, exercise is known to produce bronchodilatation (through mechanisms that remain to be clearly established), adding to greater conducting airway volume. Third, a small degree of ventilation-perfusion (\dot{V}_A/\dot{Q}) mismatching generally develops during heavy exercise, and this will further increase V_D/V_T (402). Fourth, deeper penetration of the “stationary interphase” occurs. Offsetting all of these relatively small tendencies to increase V_D/V_T is the usually dominant effect of an increased tidal volume in the context of the only small increases in conducting airway volume described above. Thus, if tidal volume increases by relatively more than conducting airway volume, V_D/V_T must fall.

Recalling that the anatomic dead space volume is about 150 ml (1 ml/lb ideal body weight is a fair rule of thumb) in an average-sized subject at rest, with a tidal volume of 500 ml, V_D/V_T would be about 0.30. On heavy exercise, if tidal volume were to reach 2.5 L and conducting airway volume 200 ml, V_D/V_T would be about 0.10. Normal V_D/V_T is about 0.30 to 0.40 at rest, although this value increases with age. V_D/V_T generally falls with increasing exercise intensity as tidal volume increases to support metabolic demand. The minimal value (which occurs near maximal exercise) should be less than 0.20 in younger individuals, less than 0.28 in individuals less than 40 years of age, and 0.30 for those older than 40 years; higher values are seen in many forms of lung disease. An increased V_D/V_T is one of the major factors responsible for the increased ventilatory requirement and, in turn, the increased \dot{V}_E seen in patients with a variety of respiratory disorders, particularly those that cause maldistribution of \dot{V}_A/\dot{Q} and increased alveolar dead space, including COPD, ILD, and pulmonary vascular disease (see Section VIII: INTERPRETATION).

Patients with respiratory disease may have at rest either normal or elevated values that fail to decrease normally or may even increase during exercise. Both false-positive findings for V_D/V_T due to changes in breathing pattern (48, 405) as well as false-negative results have been reported. In the study by Mohsenifar and coworkers (409), eight of nine patients with hemodynamically significant pulmonary vascular involvement due to collagen vascular disease had normal V_D/V_T responses during exercise. The authors concluded that normal V_D/V_T responses to exercise do not exclude hemodynamically significant pulmonary vaso-occlusive disease. Therefore, V_D/V_T is neither sensitive nor specific to lung disease, and thus an isolated abnormality should be interpreted carefully.

Surprisingly, the actual value of the dead space receives far less attention than the V_D/V_T during exercise tests. As the ratio is so dependent on the subject's pattern of breathing, even in normal subjects, consideration of the absolute value of V_D is to be encouraged in addition to the V_D/V_T .

11. Perceptual Assessment—Symptoms

Physical exercise is a stimulus for both physiologic and perceptual responses. Patients with respiratory disease usually report that breathlessness and/or leg discomfort are the major symptoms that “limit” exercise (4, 5, 310). Although the exact stimulus for exertional breathlessness is unknown (410), it is reasonable to consider that an exercise task produces work that is the presumed “stimulus” for provoking dyspnea and leg discomfort/effort during exertion (411). An alternative approach is to use oxygen

consumption ($\dot{V}O_2$) or minute ventilation (\dot{V}_E) as the independent variable to relate to perceptual responses during exercise.

The Visual Analog Scale (VAS) (412, 413) and the Category Ratio (CR)-10 Scale developed by Borg (414) are the major instruments currently used to quantify symptoms during an exercise test. The VAS is a line, usually 100 mm in length, with descriptors positioned at the top and bottom as anchors. Typically, the VAS is displayed on paper, and the patient places a mark on the line with a pen to indicate his/her breathlessness. The CR-10 Scale incorporates nonlinear spacing of verbal descriptors of severity corresponding to specific numbers. It is essential that each patient be given clear and concise instructions for rating dyspnea during exercise testing. Healthy individuals and patients with COPD usually report similar ratings on the VAS and CR-10 Scale during incremental exercise. In general, patients stop exercise at ratings of 5 to 8 on the CR-10 Scale or of 50–80 on the VAS.

There are several theoretical advantages of the CR-10 Scale. First, it is open ended, so that the patient can select a number greater than 10 on the CR-10 Scale; in contrast, the VAS has a ceiling, as the highest possible rating is 100 mm. Second, the presence of descriptors on the CR-10 Scale enables direct comparisons between individuals as a specific rating (e.g., 3 or moderate breathlessness) represents the same relative intensity. Comparison of VAS dyspnea ratings between individuals is problematic because the only anchors (no breathlessness or maximal breathlessness) are distinct for each person. Third, a number or descriptor on the CR-10 Scale is potentially easier to use as a dyspnea target than a length in millimeters on the VAS for prescribing/monitoring exercise training.

Initial reports on dyspnea ratings during exercise focused on peak values. However, there is more information available if a range or continuum of perceptual responses is examined. For example, the slope and intercept of the relationship between the stimulus (work) and the response (dyspnea or leg discomfort/effort) can be calculated (4, 415).

Various studies have shown that this approach can also be used to measure changes (improvement or deterioration) after specific interventions (416). For example, dyspnea ratings during exercise are reduced in patients after pulmonary rehabilitation (84), after lung volume reduction surgery (81, 83), with continuous positive airway pressure (80), and with oxygen therapy (78). These data support the use of measuring perceptual responses during exercise for evaluative purposes. Additional studies are required to further help quantitate these perceptual responses during exercise.

V. REFERENCE VALUES

The selection of normal reference values for use in the evaluation of CPET results is critical to any interpretative scheme. Normal reference values provide the comparative basis for answering important questions concerning the normalcy of exercise responses in patients and can significantly impact the clinical decision-making process. Standardization of normal reference values processes/practices for CPET is necessary to facilitate interpretation and optimize clinical application (6, 112). This section addresses issues related to reference values for normal sedentary North American subjects. A discussion and critique of currently available reference values for both peak (maximal) and submaximal exercise, recommendations for present use, and for future studies necessary for the evaluation of multiple cardiopulmonary and pulmonary gas exchange variables obtained during a progressive maximal symptom-limited CPET on a cycle ergometer are provided.

1. Requirements for an Optimal Set of Normal Reference Values

The following statements were extracted from the available literature (6, 18, 43, 112, 417–419) and from the personal experience of members of the committee.

1.1. Population characteristics. Subjects should preferably be community based rather than hospital based. The subjects studied should possess characteristics similar to those of the patient population to which the reference values will be applied. Minimally, this should include age, sex, and anthropomorphic considerations. Also important is level of physical activity, racial composition, dwelling altitude, occupational exposure, and knowledge of any significant coexisting medical condition and/or medications. This is best achieved by a standardized questionnaire.

1.2. Sample size. The number of subjects tested should be sufficiently large to permit an appropriately powered sample size with a uniform distribution of subjects for sex and age groups. Specific attention should be given to the need to include women and older individuals, given the changing demographics and paucity of reliable population-based CPET data for these groups.

1.3. Randomization. The study design of future reference value initiatives should include a randomization process to avoid the potential bias seen when more physically active subjects volunteer for the study.

1.4. Quality assurance of equipment and methodologies. Appropriate quality was achieved using recommendations contained in the present document.

1.5. CPET protocols. CPET protocols should be in accordance with recommendations specified in the present document.

1.6. Treatment of data. CPET results obtained by either breath-by-breath analysis or mixing chamber should be treated in accordance with recommendations contained in the present document. CPET results should be interval averaged, preferably every 30–60 seconds (to avoid the noise of shorter intervals), and the peak value reported should represent the mean of the last completed stage or of all the data collected during the final stage, but preferably for not less than 30 seconds.

1.7. Validation. Reference equations must be validated in populations other than those used to generate the existing data.

1.8. Statistical treatment of data. The function that most accurately describes the distribution of the data should be used. For example, curvilinear (power) functions may more accurately describe the distribution of the data. Furthermore, the precision of the individual and population predicted values should be reported.

2. Alternative Approach to Obtain Normal Reference Values

Until an appropriate set of normal reference values becomes available, a metaanalysis (420) of the most important variables ($\dot{V}O_2$, \dot{V}_E , and HR) may be a viable alternative. However, previous attempts at combining the large number of reports on predicted values for $\dot{V}O_{2\max}$ (421–423) demonstrate the limitations of such an approach, including sampling bias, heterogeneity of methods and subjects, uneven quality of primary data, inadequate statistical treatment of the data, and so on (424).

3. Evaluation and Critique of the Most Current Reference Values

From a historical perspective, a thorough review of the world's available sizeable literature for aerobic capacity ($\dot{V}O_{2\max}$) on population samples until 1966 has been done by Shephard (417). However, reference values for most other cardiopulmonary variables during exercise, including more recent work (Table 12),

TABLE 12. NORMAL REFERENCE VALUES FOR MAXIMAL INCREMENTAL CARDIOPULMONARY EXERCISE TESTING MEASUREMENTS

First Author (Ref.)	Sample Size (M/F)	Age (yr)	Sample Characteristics	Smokers Included	Treadmill or Cycle	Protocol	Primary Variables Measured	Methodology	Time Averaging (s)	Limitations*
Bruce (533)	138 M/157 F	29-73	General population; sedentary/active; prospective/retrospective	Yes	Tr	Bruce	$\dot{V}O_2$	Douglas bag, gas analyzer	60/25	2, 3, 4, 8
Froelicher (534)	519 M/191 M	20-53	Air force medical referrals; physically very fit group	?†	Tr	Balke; elev. 1%/min	$\dot{V}O_2$, HR	Douglas bag	60	3, 47, 8
Drinkwater (535)	109 F	10-68	General population; prospective	?	Tr	Balke; elev. 1%/min	$\dot{V}O_2$, $\dot{V}E$, HR, venous lactate	Automated system, gas analyzers, gas meter	60	3, 47, 8
Hansen (235)	77 M	34-74	Asbestos exposed; referrals; retrospective; $\dot{V}O_2$ adjusted to Bruce references and corrected for cycle	Yes	Cy	Incremental; 10-30 W/min	$\dot{V}O_2$, $\dot{V}CO_2$, $\dot{V}E$, HR, AT, P_{ETCO_2} , P_{ETCO_2} , ABCs, V_D/V_T , $P(A-a)O_2$	Gas exchange by automated system, arterial line	20	1, 2, 3, 4, 5, 8
Jones (427)	50 M/50 F	15-71	University workers/general population; prospective	Yes	Cy	Incremental; 16 W/min	$\dot{V}O_2$, $\dot{V}CO_2$, $\dot{V}E$, HR, AT	Dry gas meter, mass spectrometer, mixing chamber	15	1, 3, 4, 8
Vogel (536)	1,514 M/375 F	17-55	US soldiers; prospective; physically active; random	?	Tr	Discontinuous; 3-min stages	$\dot{V}O_2$	Douglas bag, gas analyzers	60	47, 57, 8
Jones (419)	732 M/339 F	20-70	Hospital referrals; retrospective	?	Cy	Incremental; 16 W/min	WR	Electronic cycle ergometer	60/30	2, 3, 47, 6, 7, 8
Blackie (425)	47 M/81 F	55-80	Hospital based; senior centers; prospective	Yes	Cy	Incremental; 16 W/min	WR, $\dot{V}O_2$	Turbine, mixing chamber	30	1, 3, 4, 7, 8
Storer (537)	115 M/116 F	20-70	General population; prospective; sedentary	?	Cy	Incremental; 15 W/min	$\dot{V}O_2$, WR	Mixing chamber/ B by B, turbine	30	3, 4, 8
Blackie (356)	111 M/120 F	20-80	General population; prospective; sedentary?	Yes	Cy	Incremental; 16 W/min	$\dot{V}O_2$, $\dot{V}CO_2$, $\dot{V}E$	Turbine, mixing chamber	30	3, 4, 6, 7, 8
Fairbarn (428)	111 M/120 F	20-80	General population; prospective; sedentary?	Yes	Cy	Incremental; 16 W/min	$\dot{V}O_2$, HR	Turbine, mixing chamber	30	3, 4, 6, 7, 8
Inbar (431)	1,424 M	20-70	General population ?; retrospective; sedentary	Yes	Tr	Balke modif.; elev. 2%/min	$\dot{V}O_2$, $\dot{V}CO_2$, AT, HR, $\dot{V}E$, P_{ETCO_2} , P_{ETCO_2}	B by B, turbine, gas analyzers	30	2-4, 7, 8
Neder (426)	60 M/60 F	20-80	University workers; prospective; randomized	Yes	Cy	Ramp; 10-30 W/min	WR, $\dot{V}O_2$, $\dot{V}CO_2$, AT, HR, $\dot{V}E$	Pneumotach, B by B, gas analyzers	15	1, 4, 5, 77, 8

Definition of abbreviations: ABCs = Arterial blood gases; AT = anaerobic threshold; B by B = breath by breath; Cy = cycle; Elev. = elevation; F = female; HR = heart rate; M = male; modif. = modification; $P(A-a)O_2$ = alveolar-arterial difference for oxygen pressure; P_{ETCO_2} = end-tidal P_{CO_2} ; P_{ETCO_2} = end-tidal PO_2 ; Tr = treadmill; V_D/V_T = ratio of physiologic dead space to tidal volume; $\dot{V}E$ = minute ventilation; $\dot{V}CO_2$ = carbon dioxide output; $\dot{V}O_2$ = oxygen uptake; WR = work rate.

Adapted by permission from Reference 269.

* Limitation codes are described in Section V,3: EVALUATION AND CRITIQUE OF THE MOST CURRENT REFERENCE VALUES.

† ? = Not stated.

have been obtained with rather small sample sizes. The few studies that report larger sample sizes usually measured a reduced number of variables. The most important characteristics of the most current and relevant sets of CPET reference values are presented in Tables 12 and 13. Each of the studies has various numbers of shortcomings and limitations, which are noted in Tables 12 and 13 in the far right-hand column, using the following coded number scheme:

1. Small number of subjects studied
2. Retrospective study
3. Lack of randomization
4. Inclusion of smokers in the sample studied
5. Inclusion of different racial groups
6. Level of physical activity not reported
7. Lack of quality control
8. Lack of definition of the confidence limits for individual or specified characteristics

From the analysis of currently available sets of reference values, it can be concluded that none of these studies fulfill the requirements for “optimal” reference values noted previously. Among the most commonly used sets of reference values, there are significant differences in the population characteristics, sample size, equipment, methodology, and measurements reported. The reference values given by Jones and coworkers (Table 14) and by Hansen and coworkers (Table 15) are most widely used. Jones and coworkers (419) and Blackie and coworkers (425) studied an older population to correct for the skewness of the

predicted values for this group; however, only WR, $\dot{V}O_2$, and $\dot{V}E$ were reported, with much discussion concerning the reliability of the data from the turbine equipment used in the studies by Blackie and coworkers. A new set of reference values has been published (426). This was a prospective and randomized study of sedentary subjects performed in Brazil, using a sample that included subjects of different ethnic groups. However, the number of subjects for each age group was small and the reference values for $\dot{V}O_2$ peak were lower than values previously cited most often for men, including those obtained in asbestos-exposed workers (235). It would appear that these reference values may be less applicable to a general population and more appropriate for the multiethnic population from which the sample was obtained (426). In the interim and until a new set of “optimal” reference values are available, the committee considers that the two most widely used sets of reference values—Jones and coworkers (427) (Table 14) and Hansen and coworkers (235) (Table 15)—should continue to be used clinically.

4. Reference Values for Submaximal Levels of Exercise

Unfortunately, only a limited number of reference values for submaximal levels of exercise are available. Fairbarn and coworkers (428) have provided normal predicted equations for submaximal $\dot{V}O_2$ and HR. Currently, the most widely used reference values for submaximal exercise are from Spiro and coworkers (220), who provided normal values for HR and $\dot{V}E$ at 0.75, 1, and 1.5 L of $\dot{V}O_2$ for men and women, ages 20-64 years old. Jones and colleagues (43, 427) have also reported normal values

TABLE 13. NORMAL REFERENCE VALUES FOR ARTERIAL BLOOD GAS AND PULMONARY GAS EXCHANGE VARIABLES MEASURED DURING MAXIMAL CARDIOPULMONARY EXERCISE TESTING

First Authors (Ref.)	Sample Size (M/F)	Age (yr)	Sample Characteristics	Smokers Included	Treadmill or Cycle	Protocol	Primary Variables Measured	Methodology	Time Averaging	Limitations*
Jones (405)	17 M	21–37	Physically active; prospective	?†	Cy	Multistage; SS, 4–6 min	ABGs, P(A-a)O ₂ , V _D /V _T	Severinghaus and Beckman electro	2 min	1, 3, 8
Wasserman (538)	10 M	23–31	Medical students; no competitive athletes	?	Cy	Discontinuous; CW, 50–30 min	ABGs, P(A-a)O ₂ , V _D /V _T	Blood gas analysis; bag gas collection	1 min	1, 3, 47, 6, 8,
Hansen (539)	16 M	18–24	General population; randomized	?	Cy	Multistage; CW, 4–15 min	ABGs, P(A-a)O ₂ , Sa _{o₂}	Blood gas analysis; mixing bag	1–4 min	1, 47, 6, 8
Hartley (540)	15 M	38–55	Sedentary; randomized	?	Cy	Multistage; CW, 5–8 min	ABGs, P(A-a)O ₂ , pH	Blood gas analysis; Douglas bag	3 min	1, 47, 8
Whipp (541)	5 M	20–28	General population?; prospective	?	Cy	Multistage; 56 W/6 min	ABGs, P(A-a)O ₂ , V _D /V _T	Blood gas analysis; Douglas bag		1, 3, 8
Dempsey (542)	10 M	22–40	Healthy adults	?	Tr	Intermittent, ~3.2 mph, 3%/4 min	ABGs, P(A-a)O ₂ , V _D /V _T , pH	ABG: Polarographic; mixing chamber	45–75 s	1, 3, 6, 8
Bradley (543)	12 M/12 F	20–71	General population	Yes	Tr	8 min, 3 mph, 5–15%	V _D /V _T , P(A-a)O ₂	Radiometer; mixing chamber	1 min	1, 3, 4, 5, 6, 7, 8
Dempsey (396)	16 M	20–45	Highly trained runners	?	Tr	~10 mph, 2%/min, and CW	ABGs, P(A-a)O ₂ , V _D /V _T , pH, HCO ₃ ⁻	Radiometer; gas exchange, customized	?	1, 3, 8
Hansen (235)	74 M	34–74	Shipyards workers; some with DOE, hypoxemia	Yes	Cy	Incremental; minute by minute	ABGs, P(A-a)O ₂ , V _D /V _T , pH, HCO ₃ ⁻	Radiometer ABL-1; V̇O ₂ and V̇CO ₂ , automated system	20 s	1, 2, 3, 4, 5, 8
Wagner (402)	8 M	25–41	Physically active; prospective	?	Cy	Multistage; 60 W/ 4–10 min	ABGs, P(A-a)O ₂ , pH, [La ⁻]	IL-213, IL-282 CO-ox; Tissot	2 min?	1, 3, 47, 8
Malmberg (544)	25 M 25 M	20–65 20–65	General population Prospective	No Yes	Cy Cy	Multistage; 50 W/ 6 min	ABGs, P(A-a)O ₂ , V _D , pH	ABL-1, IL-182, Douglas bag	3 min 3 min	1, 3, 6, 8

Definition of abbreviations: ABGs = Arterial blood gases; CW = constant work rate test; Cy = cycle; DOE = dyspnea on exertion; F = female; M = male; P(A-a)O₂ = alveolar-arterial difference for oxygen pressure; Sa_{o₂} = arterial oxygen saturation; SS = steady state; Tr = treadmill; V_D = physiologic dead space; V_D/V_T = ratio of physiologic dead space to tidal volume; V̇CO₂ = carbon dioxide output; V̇O₂ = oxygen uptake.

Adapted by permission from Reference 6.

* Limitation codes are described in Section V,3: EVALUATION AND CRITIQUE OF THE MOST CURRENT REFERENCE VALUES.

† ? = Not stated.

for V̇O₂, V̇CO₂, HR, and V̇E for a wide range of normal individuals at fixed work rates. Submaximal reference values are also given by Cotes (169, 429, 430). Although some of the studies that report maximal reference values also have submaximal data presented graphically (356, 431), the predicted equations for the submaximal data are not provided. Available reference values for submaximal exercise have many of the deficiencies previously enumerated for peak values. The recommendation of the committee is to encourage multicenter studies that will provide both peak and submaximal exercise reference values.

5. Reference Values for Arterial Blood Gases, P(A-a)O₂, and V_D/V_T during CPET

Because of the invasive nature of these measurements, there is less available information about ABGs, P(A-a)O₂, and V_D/V_T obtained during CPET compared with noninvasive cardiopulmonary variables. The majority of these studies included small num-

bers of subjects, uncertain quality control, and various population characteristics including uncertain smoking histories; used different protocols and time-averaging techniques; and established no confidence limits for the population being evaluated. In general, reference values for pulmonary gas exchange variables are less well validated compared with noninvasive cardiopulmonary variables. Table 13 summarizes the characteristics of the available, most widely used studies. Hansen and coworkers (235) have provided the most complete set of reference values for pulmonary gas exchange variables, which are widely used. However, it should be recognized that they were obtained from asbestos-exposed men, including smokers, subjects with hypoxemia, and others with unrecognized concurrent illness. Until a new set of “optimal” reference values for pulmonary gas exchange as previously defined is available, the committee considers that the most widely used pulmonary gas exchange reference values, produced by Hansen and coworkers (235), should continue to be used clinically for patients.

TABLE 14. SELECTED REFERENCE VALUES FOR MAXIMAL INCREMENTAL EXERCISE TEST

Variable	Equations*	SEE
Work rate, kpm/min	20.4 (ht) – 8.74(age) – 288(sex) – 1909	216
V̇O ₂ , L/min	0.046(ht) – 0.021 (age) – 0.62(sex) – 4.31	0.458
HR, beats/min	202 – 0.72(age)	10.3
O ₂ pulse, ml/beat	0.28(ht) – 3.3(sex) – 26.7	2.8
V̇E, L/min	26.3(V _C) – 34	23.1
AT, L/min (V̇O ₂)	0.024(ht) – 0.0074(age) – 2.43	0.316

Definition of abbreviations: HR = Heart rate; SEE = standard error of estimate; V̇E = minute ventilation; V̇O₂ = oxygen uptake.

Adapted by permission from Reference 427.

* Sex, male, 0; female, 1; age, years; height (ht), centimeters.

TABLE 15. SELECTED REFERENCE VALUES FOR MAXIMAL INCREMENTAL CYCLE EXERCISE TEST

Variables	Equations*
$\dot{V}O_2$, ml/min, male	$W \times [50.75 - 0.372 (A)]$
$\dot{V}O_2$, ml/min, female	$(W + 43) \times [22.78 - 0.17 (A)]$
HR, beats/min	$210 \times 0.65 (A)^\dagger$
O_2 pulse, ml/beat	Predicted $\dot{V}O_{2,max}$ /predicted HRmax
\dot{V}_E/MVV , %	$\sim 72 \pm 15$
AT, L/min ($\dot{V}O_2$)	$> 40\% \dot{V}O_2$ pred

Definition of abbreviations: AT = Anaerobic threshold; HR = heart rate; \dot{V}_E = minute ventilation; $\dot{V}O_2$ = oxygen uptake.

Data from References 235, 533, and 210.

* Age (A): years; height (H): centimeters; weight (W), kilograms.

Predicted weight men: $0.79 \times H - 60.7$. Predicted weight women: $0.65 \times H - 42.8$. When actual weight $>$ predicted, the predicted weight should be used in the equations. Wasserman and colleagues introduced new corrections factors (3, 210), which have not yet been published in peer reviewed journals.

[†] See Lange-Andersen and coworkers (345).

6. Practical Approach for the Selection of Reference Values

In accordance with the same recommendations of the ATS for the selection of reference values for lung function (18), each exercise laboratory must select an appropriate set of reference values that best reflects the characteristics of the population tested, and the equipment and methodology utilized. Also, it is recommended that tests include 10 healthy males and 10 healthy females of similar age, anthropometric characteristics, and level of physical activity relative to the patients to be studied and that the results be compared empirically with different sets of reference values. The reference values that better characterize the sample of healthy volunteers tested as normal should be selected.

VI. NORMAL INTEGRATIVE EXERCISE RESPONSE

A summary of typical normal cardiovascular and pulmonary responses to progressive exercise is shown in Figure 11. In the normal healthy adult, there may be a slight anticipatory increase in heart rate, blood pressure, and ventilation before the onset of exercise. Once contraction of locomotor muscles begins, there are both central and peripheral mechanisms governing the appropriate regulation of cardiopulmonary responses.

$\dot{V}O_2$ rises fairly linearly with work rate (Figure 11A) throughout progressive exercise because of an increase in cardiac output ($HR \times SV$) and increased oxygen extraction at the tissues. Early exercise is associated with a combined increase in stroke volume (not shown) and heart rate (Figure 11B), whereas late in exercise the rise in cardiac output is mostly dependent on increases in heart rate. Oxygen pulse [$SV \times C(a-\bar{v})O_2$] (Figure 11B) also rises linearly early in exercise, but tends to plateau later in exercise as both SV and the $C(a-\bar{v})O_2$ begin to plateau. $\dot{V}O_2$ is relatively insensitive to small changes in \dot{V}_E (e.g., hyperventilation) as long as the \dot{V}_E is adequate to maintain Pa_{O_2} .

Ventilation rises early in exercise as a result of an increase in tidal volume (V_T) and frequency (fr) of breathing (Figure 11E). As exercise progresses, V_T tends to level off at about 50% of the VC (likely in part to limit the elastic load associated with high and low lung volumes) and subsequent increases in \dot{V}_E are due to increases in fr (increasing three- to fourfold from resting levels).

Ventilation increases linearly with $\dot{V}O_2$ (Figure 11G) and $\dot{V}CO_2$ until the approximate time when lactate begins to increase in the arterial blood. At this point, \dot{V}_E and $\dot{V}CO_2$ begin to increase out of proportion to $\dot{V}O_2$ (Figures 11C and 11G). The rise in \dot{V}_E

is initially sufficient to compensate for the metabolic acidosis. Buffering of the lactic acidosis yields the increase in $\dot{V}CO_2$ with respect to $\dot{V}O_2$. Thus the ventilatory equivalents for $\dot{V}CO_2$ (Figure 11F) fall with light exercise and stay constant with moderate exercise while the ventilatory equivalents for $\dot{V}O_2$ begin to rise.

Alveolar and arterial oxygen partial pressures as well as the difference between both variables remain fairly constant with light exercise in health (similar to rest), occasionally even narrowing slightly. With moderate exercise (beyond 50% of peak $\dot{V}O_2$), $P_{(A-a)O_2}$ begins to widen while \dot{V}_A increases to maintain Pa_{O_2} and Sp_{O_2} (Figure 11H) near resting levels. Pa_{CO_2} , P_{ETCO_2} , P_{ETCO_2} , and pH all remain fairly constant with light exercise (Figure 11I).

With heavy exercise an additional stimulus to ventilation (including H^+) occurs and \dot{V}_E begins to increase out of proportion to $\dot{V}CO_2$. With this attempt at ventilatory compensation for metabolic acidosis, Pa_{CO_2} and P_{ETCO_2} (Figure 11I) fall and $\dot{V}_E/\dot{V}CO_2$ (Figure 11F) rises, yet in most cases pH still falls to between 7.25 and 7.35. Despite the widened alveolar-to-arterial PO_2 difference, generally \dot{V}_E and consequently \dot{V}_A increase enough to maintain Pa_{O_2} near resting levels.

The dead space ventilation (in absolute terms) increases with exercise; however, the dead space-tidal volume ratio (V_D/V_T) falls. There is a tendency for V_D/V_T to increase slightly near peak exercise as fr increases and in some cases V_T falls.

Normal Exercise Limitation

The mechanisms of exercise limitation in healthy individuals are difficult to establish because many interacting factors are potentially responsible (142, 310, 432–434). The question is not “what is the limiting factor to maximal exercise?” but, rather, “what is the potential relative importance of each of the factors involved in the exercise response?”

In a normal individual, ventilation does not appear to be the limiting factor, because at maximal exercise there is significant ventilatory reserve (Figures 11D and 11G) with Pa_{CO_2} decreasing, indicating that the bellows are capable of removing CO_2 efficiently. In addition, pulmonary gas exchange does not appear to limit exercise, because blood O_2 saturation (Figure 11H) and content are kept near baseline values despite some widening of the alveolar-to-arterial oxygen difference (401, 435). If O_2 delivery to the skeletal muscles is increased, the person is able to do more exercise, indicating that the metabolic and contractile properties of the skeletal muscles are not the limiting factors. There is good evidence that the muscles are capable of utilizing whatever O_2 is supplied to them (i.e., good metabolic reserve) (436). In normal subjects, maximal exercise appears limited by O_2 delivery; there is a linear relationship between O_2 delivery and $\dot{V}O_2$. O_2 delivery (convective O_2 transport) is the product of cardiac output and arterial O_2 content. As arterial O_2 content is normally maintained even at peak exercise, cardiac output is likely the limiting link (142, 436, 437). Adding other exercising muscles to the two-legged exercise does not increase $\dot{V}O_{2,max}$, suggesting that O_2 blood flow (cardiac output) has reached its maximal capacity.

The importance of the diffusive capacity of O_2 transport at the tissue level (muscle) has been emphasized (143, 432). O_2 delivery determines skeletal muscle capillary PO_2 (P_{cO_2}). The movement of O_2 from the capillary to the mitochondria is the O_2 tissue diffusion of the muscle. The O_2 tissue diffusion capacity is directly related to the pressure gradient between capillaries and mitochondria. Because P_{cO_2} is determined by O_2 delivery, there is a strong interaction between O_2 delivery (convective O_2 delivery) and the diffusion capacity of the muscle (O_2 tissue diffusion). The limiting role of O_2 tissue diffusion capacity is also

supported by the fact that $P(a-v)O_2$ does not continue to widen with progressive exercise. For any given level of convective O_2 delivery, the muscle diffusion capacity determines $\dot{V}O_{2max}$ (143).

The improvement in maximal exercise capacity of sedentary subjects who underwent training for several weeks was accomplished mostly by a combination of increased muscle blood flow (and cardiac output) and muscle O_2 diffusional conductance. Of course, the enhancements to O_2 transport require cellular metabolic adaptation as well, and it is known that bioenergetic pathways are upregulated by training, to make use of the extra O_2 delivery capacity.

In summary, there is no single exercise-limiting factor; and it appears that heart with contribution of muscle rather than lungs and blood are largely responsible for exercise limitation and for the training effects and differences in exercise capacity between people.

VII. EXERCISE LIMITATION IN CARDIOPULMONARY PATIENTS

Clinically, it is increasingly appreciated that exercise limitation in patients with reduced $\dot{V}O_{2max}$ is often multifactorial and as such not limited by any single component of the O_2 transport/utilization process but rather by their collective quantitative interaction(s). Furthermore, in contrast to normal subjects, in whom physiologic limitation to O_2 transport may be evident, patients are often symptom limited and may stop exercise before reaching limits of metabolic or gas transport capacity.

In those who do achieve physiologic limitation, there are three major categories of exercise limitation and reduced $\dot{V}O_{2max}$: *cardiovascular limitation*, which includes functional disturbances of the heart and/or the pulmonary and systemic circulation, and/or the blood (e.g., anemia, carboxyhemoglobin); *respiratory limitation*, which includes ventilatory (mechanical) and gas exchange factors; and *peripheral limitation*, which includes a broad spectrum of neuromuscular, microvascular, and metabolically related abnormalities that could impact tissue O_2 conductance, O_2 utilization, and mechanisms of contraction.

In patients with cardiovascular disease (nonischemic), although exercise intolerance appears initially limited because of reduced O_2 delivery to the exercising muscle, exercise limitation is multifactorial (see Section VIII,4.1: HEART FAILURE) (141, 438). Deconditioning and peripheral muscle factors (439) may thus variably contribute to exercise limitation. Although a spectrum of respiratory abnormalities can be seen in patients with pulmonary vascular disease, exercise is usually limited by impaired cardiovascular function and also skeletal muscle dysfunction (see Section VIII,4: PATTERNS OF EXERCISE RESPONSE IN DIFFERENT CLINICAL ENTITIES).

Exercise limitation in patients with respiratory disease is complex, multifactorial, and may be difficult to establish and clearly quantitate (74, 310). Respiratory limiting factors include decreased ventilatory capacity (mostly due to mechanical factors) and abnormal gas exchange (i.e., hypoxemia and increased dead space ventilation) and respiratory muscle dysfunction. Abnormal symptom perception (breathlessness, fatigue, etc.) (440), deconditioning, and peripheral muscle dysfunction are increasingly recognized to be important (co)contributors. Cardiovascular abnormalities resulting from cor pulmonale and/or from the hemodynamic consequences of dynamic hyperinflation may also be seen (i.e., in patients with COPD) (441, 442). Respiratory muscle dysfunction may also potentially result from dynamic hyperinflation. The coexistence of respiratory and cardiovascular abnormalities may signal the presence of combined exercise limitation (276, 443).

The role of deconditioning in patients with chronic cardiopulmonary disease and in patient status after heart, heart-lung, and lung transplantation has increased awareness of the role of peripheral limitation in exercise performance and the importance of considering this as a contributing factor in their exercise limitation (146) (see Section VIII,4.3: DECONDITIONING).

It is well appreciated that muscle mass is an important factor limiting physical work (444). Peak heart rate may be decreased as a function of a reduction of active muscle mass. Patients with cardiopulmonary disease often have reduced muscle mass. The functional consequences of such reduction are a loss of endurance, loss of strength, or both. Work has demonstrated that patients with cardiopulmonary disorders have respiratory and peripheral muscle weakness and that muscle strength is a significant contributor to exercise capacity in health and disease (5). Other work on skeletal muscle dysfunction in COPD (23, 89, 162, 163, 445–447) provides additional evidence supporting its important contribution to exercise intolerance in patients with COPD. However, more recent work in COPD has suggested that there is a skeletal muscle metabolic reserve similar to that of normal subjects, that whole body exercise in COPD is not limited by skeletal muscle function, and that other (central) factors are most probably more important (74). Furthermore, abnormalities in skeletal muscle oxidative capacity were purportedly responsible for the improved but still persistently reduced $\dot{V}O_{2peak}$ after lung transplantation (146). The importance of skeletal muscle dysfunction to exercise intolerance in COPD and other respiratory diseases including status after lung transplantation is accordingly a topic of intensive research.

VIII. INTERPRETATION

1. Introduction

CPET is often performed because other diagnostic modalities are inadequate in providing answers to important questions related to exercise intolerance, exercise limitation, and patient management. In turn, automated exercise systems provide extensive data, which require appropriate collection and interpretative processing to optimally utilize CPET results in clinical practice. The goal of this section is to make recommendations for interpretative guidelines, which emphasize how the information obtained during CPET can be appropriately presented, systematically approached, and meaningfully applied in the clinical decision-making process.

This approach begins with an overview of the CPET process (Table 7) and is followed by a summary of major areas of consideration required for interpretation of CPET, which are discussed subsequently. The broad range of physiologic concepts, including use and limitation of the variables, CPET methodologic standardization issues, and a comparative analysis of currently available reference values addressed previously, provides the basis for interpretative guidelines.

2. Interpretative Strategies

Optimal utilization of CPET in clinical practice requires appropriate presentation of the data and an interpretative strategy that is scientifically based and sufficiently flexible to be applied to a variety of clinical entities/pathophysiologic conditions. At present there is no consensus on any one approach. Therefore, several approaches to interpretation of CPET results should be considered. *Note:* Approaches that emphasize a primary mechanism of exercise limitation may be helpful but are usually inadequate, as exercise limitation is multifactorial.

Algorithms based on a single key measurement and concep-

tual framework may be helpful in differential diagnosis but are limited by excessive reliance on that single measurement. Interpretative error may result if that one measurement at a key branch point is wrong. Algorithms are also often inadequate for the evaluation of early or mild disease as well as combined disease (i.e., cardiac-pulmonary). Furthermore, although different interpretative algorithms are available, none has been clinically validated (3, 348, 448, 449). The greatest diagnostic potential and impact on the clinical decision-making process may rest, not on the utility of any one individual measurement, although some are obviously more important than others, but rather on their integrated use (1, 3, 28, 43, 112, 276). As such, an integrative approach to CPET interpretation, which emphasizes the interrelationships, trending phenomena, and patterns of key variable responses in a clinical setting framework, is recommended and is discussed.

An integrative approach to the interpretation of CPET results is summarized in Table 16 and includes the following: (1) reason(s) for CPET; (2) consideration of pertinent clinical and laboratory information (clinical status); (3) assessment of overall quality of the test, subject effort, and reason(s) for exercise cessation; (4) identification of key variables: initially $\dot{V}O_2$, and then HR, $\dot{V}E$, and Sa_{O_2} , with other measurements evaluated subsequently on the basis of the reason(s) for which CPET was done, looking for consistency among the measurements and avoiding excessive reliance on a single measurement; (5) use of both tabular and graphic presentation (formatting) of the data; (6) identification of trending phenomena (i.e., submaximal through maximal exercise results) as reflected in graphic analysis for important relationships; (7) determination of whether the measurements are normal or abnormal compared with appropriate normal reference values; (8) distinction between physiologic and pathologic causes of exercise limitation; (9) establishing patterns of exercise responses and limitations; (10) consideration of conditions/clinical entities that may be associated with these patterns; (11) correlation of exercise results with the patient's clinical information, including results of other tests; and (12) preparation of exercise report.

3. Integrative Approach: Important Issues to Be Addressed

3.1. Reason(s) for CPET. Reason(s) for which CPET was requested should be precisely determined. The reason(s) might be a specific exercise-related symptom appearing during or limiting daily or special activities. Alternatively, the exercise test may be obtained for preoperative evaluation, to assess the consequences of occupational exposure, for impairment/disability evaluation, or for the determination of exercise capacity of an

asymptomatic subject before enrollment in an exercise program (see Section II: INDICATIONS FOR CARDIOPULMONARY EXERCISE TESTING).

3.2. Clinical status evaluation. Interpretation of CPET results requires knowledge of a subject's clinical information including clinical diagnosis, results of the medical history and physical examination, PFTs, chest X-ray, ECG, and other testing as appropriate (echocardiography, bronchial provocation challenge, etc.). A health questionnaire may also be especially helpful for cardiopulmonary risk factor analysis, symptoms, occupational exposure, and determination of level of physical activity. Especially critical is knowledge of medications (i.e., β -blockers may affect heart rate response during exercise). Skeletal (i.e., joint, bone) abnormalities, especially of the lower limbs, should be noted. Laboratory data including hemoglobin and carboxyhemoglobin determinations may also be helpful. A more meaningful physiologic-clinical correlation and, in turn, accurate interpretation of CPET results is possible when a thorough clinical subject profile is available (1, 276). The above-described information should be part of the exercise "work sheet" and succinctly included in the final exercise report.

3.3. Comparison of results with appropriate reference values.

The major portion of this section focuses on CPET results generated during maximal, symptom-limited incremental cycle ergometry, which is currently the most popular, albeit not the exclusive, protocol. The impact of exercise modality (cycle exercise versus treadmill) as a function of muscle mass involved and protocol (constant work versus incremental, continuous versus discontinuous, etc.) as a reflection of differences in temporal patterns of work rate changes on interpretation is well appreciated and has been addressed previously (see Section V: REFERENCE VALUES; Section III: METHODOLOGY; and Section IV: CONCEPTUAL AND PHYSIOLOGIC BASIS OF CARDIOPULMONARY EXERCISE TESTING MEASUREMENTS). Accurate interpretation therefore requires that reference values for comparisons of patient data reflect patient factors, protocol, and equipment. The increasing use of constant work rate (submaximal) exercise testing (usually based on results generated during maximal IET) on clinical decision making was discussed in Section III,3.3 (CONSTANT WORK RATE PROTOCOL).

As previously noted, the selection of an appropriate set of reference values is a function of the patient population, age, height, weight, sex, and physical activity and may vary from laboratory to laboratory (3, 43, 269) (see Section V: REFERENCE VALUES). Prediction equations usually do not take physical activity into consideration; accurate interpretation certainly requires

TABLE 16. INTEGRATIVE APPROACH TO THE INTERPRETATION OF CARDIOPULMONARY EXERCISE TESTING RESULTS

1. Determine reason(s) for CPET
2. Review pertinent clinical and laboratory information (clinical status)
3. Note overall quality of test, assessment of subject effort, and reasons for exercise cessation
4. Identify key variables: initially $\dot{V}O_2$, and then HR, $\dot{V}E$, Sa_{O_2} , and other measurements subsequently
5. Use tabular and graphic presentation of the data
6. Pay attention to trending phenomena: submaximal through maximal responses
7. Compare exercise responses with appropriate reference values
8. Evaluate exercise limitation: physiologic versus nonphysiologic
9. Establish patterns of exercise responses
10. Consider what conditions/clinical entities may be associated with these patterns
11. Correlate CPET results with clinical status
12. Generate CPET report

Definition of abbreviations: CPET = cardiopulmonary exercise testing; HR = heart rate; Sa_{O_2} = arterial oxygen saturation; $\dot{V}E$ = minute ventilation; $\dot{V}O_2$ = oxygen uptake.

Adapted by permission from Reference 1.

such knowledge. For example, very fit individuals and athletes may experience significant reductions in their peak $\dot{V}O_2$ as a result of pulmonary, cardiac, or (peripheral) muscle illness and still be within the normal confidence interval for sedentary subjects. Because most exercise variables may vary with work rate/metabolic rate, observed data should be compared with these values predicted at the same work rate or metabolic rate if available. Limited submaximal reference value data are available (see Section V: REFERENCE VALUES). Peak or maximal exercise values are most often used for comparison, because the greatest number of reference values is available for maximal exercise variables. However, exclusive reliance on peak exercise results should be avoided. Different sets of maximal (or peak) reference values can have significant impact on interpretation of CPET results (276).

3.4. Measurements and graphic interrelationships. An impressive number of primary and secondary (derived) variables can be measured during CPET. The number of variables to be measured in any one situation will depend on the reasons for which CPET was requested. Key measurements obtained during CPET and the plots of important graphic interrelationships between these measurements appear in Tables 10 and 11, respectively (see Section IV: CONCEPTUAL AND PHYSIOLOGIC BASIS OF CARDIOPULMONARY EXERCISE TESTING MEASUREMENTS). Although the conceptual basis and clinical use/limitation for these measurements have been discussed previously, additional salient comments relevant to interpretation will be noted. Although the measurements in Table 10 are grouped into categories, abnormality of a variable does not necessarily define exercise limitation in that category. Also, in Table 10, the measurements are represented as noninvasive or invasive (i.e., arterial sampling intervention); decision analysis for obtaining invasive determinations is discussed in Section III (METHODOLOGY).

The measurements in Table 10 were selected because of their clinical utility and because of the way they impact the clinical decision-making process by (1) determining whether exercise capacity was reduced and establishing the most likely source(s) of exercise limitation, (2) aiding in detecting clinically occult disease, (3) helping to distinguish between clinical entities, and (4) assessing response to treatment. Finally, the measurements included in Table 10 are not intended to be exhaustive and will likely change in the future as experience with new methodologies (i.e., exercise tidal flow-volume loops) and variables (EELV) evolve (288, 372, 374, 378, 450, 451).

3.5. Symptoms. The quantification and characterization of symptoms during exercise are increasingly being utilized for clinical decision making (82, 411, 452). This is because measurement tools are available, are more rigorously applied, and relationships (of symptoms, especially dyspnea) to physiologic variables are more firmly established (4, 75, 83, 97, 416). Furthermore, as many patients with cardiopulmonary disorders are symptom limited rather than physiologically limited, quantitating and interrelating a symptom to physiologic variables are practical and helpful (5, 310). The most commonly evaluated symptoms are chest pain, exertional breathlessness, general fatigue, and leg fatigue. The modified Borg Scale is the most widely used in providing a rating of perceived exertion (414); its reproducibility for the measurement of dyspnea during exercise is good (85, 256, 453) (see Section IV, 11: PERCEPTUAL ASSESSMENT).

3.6. Data presentation. Graphic representations of these variable interrelationships are routinely provided by automated exercise systems and are helpful. However, selection of the most appropriate format for data display is important for discriminating patterns of abnormality in the exercise response. Suggested forms for tabular and graphic reports of the results of incremen-

tal CPET in a normal middle-aged male appear in Table 19 and Figure 11, respectively. The trending phenomena as work rate progresses from submaximal to peak exercise provided in these graphs enhance interpretation so that the entire exercise response may be appreciated in addition to the maximal values, which are also usually presented in tabular form (see Table 19). Although underutilized, these submaximal graphic data are revealing and can often be diagnostic (49). Optimal interpretation requires that CPET results be evaluated on the basis of both tabular and graphic expressions of the data, with careful attention given to trending phenomena. In addition, the use of the appropriate corresponding reference values for each plot greatly enhances interpretation and is recommended (1, 276, 454, 455). Interpretation is facilitated if both the tabular and graphic data reflect interval-averaged data (30–60 seconds) rather than breath-by-breath data so that “noise” is minimized (see Section III: METHODOLOGY). The appropriateness or inappropriateness of the response of a variable, compared with the corresponding reference value, is the basis for determining normal or abnormal exercise responses and exercise limitation. Table 17 contains CPET variable responses and suggested “normal” guideline values often used in the interpretation of CPET results. Additional work is required to define normal values (see Section V: REFERENCE VALUES and Section IX: RECOMMENDATIONS FOR FUTURE STUDIES).

3.7. Assessment of patient effort. Knowledge of patient effort and motivation is necessary for the accurate interpretation of a maximal CPET. This is especially true when maximal exercise capacity is reduced. The reproducibility of maximal exercise capacity in normal subjects and patients with cardiac or pulmonary disease is well established (263, 264, 266, 267). Some studies have shown that measured $\dot{V}O_2$ is more reproducible on repeat testing when compared with peak work rate (see Table 6). Consequently, this suggests that patient effort is usually maximal or that it does not vary significantly with time. Patient effort can be optimized by familiarization before and encouragement during CPET (see Section III, 3: EXERCISE TESTING PROTOCOLS). Submaximal efforts may interfere with the interpretation of CPET results and, in turn, patient management. If a subject’s effort appears submaximal, it should be stated in the report. Patient effort becomes an important consideration when $\dot{V}O_{2peak}$ is reduced and physiologic limitation is not achieved. Questions then include the following: was the patient symptom limited? Was it poor effort, or possibly some other factor(s)? Another very important question: what is the impact on clinical decision making? Work has underscored this issue in patients with heart failure being evaluated for cardiac transplantation, as $\dot{V}O_{2peak}$ is so critical in clinical decision analysis (456).

There is considerable variability in the objective markers used for the determination of a “maximal” exercise test. These markers include heart rate achieved, lactate level, plateau in oxygen uptake, bicarbonate or pH drop, and RER (457). Currently, however, there is no gold standard for the assessment of maximal effort. Patient effort is usually considered to be maximal if one or more of the following occur:

1. The patient achieves predicted peak oxygen uptake and/or a plateau is observed.
2. Predicted maximal work rate is achieved.
3. Predicted maximal heart rate is achieved.
4. There is evidence of ventilatory limitation, that is, peak exercise ventilation approaches or exceeds maximal ventilatory capacity.
5. Although no one RER value defines maximal effort, values greater than 1.15 are more likely to be associated with near maximal or maximal effort (277).

TABLE 17. SUGGESTED NORMAL GUIDELINES FOR INTERPRETATION OF CARDIOPULMONARY EXERCISE TESTING RESULTS*

Variables	Criteria of Normality
$\dot{V}O_{2\max}$ or $\dot{V}O_{2\text{peak}}$	> 84% predicted
Anaerobic threshold	> 40% $\dot{V}O_{2\max}$ predicted; wide range of normal (40–80%)
Heart rate (HR)	HRmax > 90% age predicted
Heart rate reserve (HRR)	HRR < 15 beats/min
Blood pressure	< 220/90
O ₂ pulse ($\dot{V}O_{2\text{p}}/\text{HR}$)	> 80%
Ventilatory reserve (VR)	MVV – $\dot{V}emax$: > 11 L or $\dot{V}emax/MVV \times 100$: < 85%. Wide normal range: $72 \pm 15\%$
Respiratory frequency (fr)	< 60 breaths/min
$\dot{V}E/\dot{V}CO_2$ (at AT)	< 34
V_D/V_T	< 0.28; < 0.30 for age > 40 years
Pa _{O₂}	> 80 mm Hg
P(A–a)O ₂	< 35 mm Hg

Adapted by permission from References 1, 3, 43, 235, 292, and 545.

* Maximum or peak cardiopulmonary responses except for anaerobic threshold and $\dot{V}E/\dot{V}CO_2$ at AT.

6. Patient exhaustion/Borg Scale rating of 9–10 on a 0-to-10 scale.

It should be emphasized that a fall in Pa_{O₂} or Sa_{O₂}/Sp_{O₂} (less than 55 mm Hg or less than 88%, respectively) does not necessarily indicate that a patient's effort was maximal, as such falls can be observed during submaximal exercise in several clinical entities including ILD and PVD. Although chest pain, ischemic ECG changes, and heart rate and BP drops may be indications for stopping an exercise test, these events may occur before maximal exercise and, therefore, are not good measures of maximal effort.

Quantification of intensity of symptoms during exercise, using either the Borg Scale or Visual Analog Scale, for ratings of perceived exertion may assist in the assessment of motivation or effort; at present they are useful adjuncts to physiologic data in determining adequacy of effort (*see* Section VIII,3.5: SYMPTOMS). Only a minority of (apparently) well-motivated normal subjects or patients with chronic respiratory disease rate dyspnea or sensation of leg effort as maximal (10 on the modified Borg Scale) when they stop exercise (458). Work has noted that the Borg Scale dyspnea target intensity scores correlate with $\dot{V}O_{2\text{peak}}$ in patients with COPD (452). In the final analysis, the assessment of subject motivation and effort requires attention to several factors including physiologic variables, observation of the patient, and quantification of symptom(s).

3.8. Reasons for stopping. Reason(s) for stopping the exercise test, using the modified Borg Scale or VAS and the subject's own words, should be included and reported with the variable responses. In addition, the observations of the individual monitoring the exercise test, including other occurrences during the test and condition of the subject at the point of discontinuing exercise, should also be noted as they may impact interpretation. Relevant comments would be, for instance, patient appeared exhausted, not obviously stressed, too breathless to talk, ataxic, sweating, pale, and so on.

4. Patterns of Exercise Response in Different Clinical Entities

Typical CPET response patterns for several clinical entities are summarized in Table 18. The following narrative provides an expanded and more detailed discussion of these and some additional clinical entities. The normal exercise response pattern has been discussed previously (*see* Section VI: NORMAL INTEGRATIVE EXERCISE RESPONSE; and Figure 11). Table 18 is admittedly oversimplified and does not permit the wide range of responses that may be seen within a full spectrum (mild to severe) of patients

with lung, heart, or metabolic (muscle) disease or in patients with combined diseases. It must be clearly appreciated that significant overlap exists in the exercise responses of patients with different respiratory and cardiac diseases. Furthermore, wide confidence intervals for exercise responses in normal subjects are also noted (356). In addition, patients often have coexisting conditions (obesity, diabetes, deconditioning, etc.) and a multifactorial etiology to exercise intolerance. Usually, however, one or more variable response(s) predominate(s), permitting prioritization of contributing factors. Accurate interpretation requires appreciation of such overlap and variability.

4.1. Heart failure. Multiple factors contribute to exercise intolerance in patients with cardiovascular disease (459). These include inadequate O₂ delivery due to variably severe abnormalities in heart rate response, systolic and diastolic dysfunction, and abnormalities in the distribution and impedance of blood flow in the peripheral circulation; abnormal pulmonary vascular responses, as well as skeletal muscle abnormalities including deconditioning (i.e., O₂ utilization and muscle metabolism); and abnormal ventilatory responses (12, 36, 62, 141, 310, 459–467). In consequence, a reduced peak work rate and peak $\dot{V}O_2$ compared with normal subjects, owing to one or several of these factors, is usually observed. Functional classification of severity of heart failure, prognosis, and selection for transplantation (*see* Section II: INDICATIONS FOR CARDIOPULMONARY EXERCISE TESTING) is currently based on $\dot{V}O_{2\max}$ (36, 44, 59–61).

The ratio of increase in $\dot{V}O_2$ to increase in external work ($\Delta\dot{V}O_2/\Delta\text{WR}$) has been reported to be decreased in patients with heart disease (195, 468), although this has not been consistently observed. Early onset of metabolic acidosis is manifested by a reduced anaerobic threshold and early fall in Pa_{CO₂}. The O₂ pulse is usually low, with an abnormally “flattened” appearance compared with the normally “flattened” appearance (*see* Section IV: CONCEPTUAL AND PHYSIOLOGIC BASIS OF CARDIOPULMONARY EXERCISE TESTING MEASUREMENTS, for comments concerning the constellation of factors that can impact O₂ pulse and for a discussion of the relationship of O₂ pulse to stroke volume).

Higher HR responses at submaximal levels of $\dot{V}O_2$ are observed; the steepness (rate of rise of HR relative to $\dot{V}O_2$) and deviation from linearity of the normal HR– $\dot{V}O_2$ relationship is highly variable. Patients with mitral valvular disease (469) and angina, for instance, may have impressive increases in slope. However, so do some patients with metabolic myopathy (54); a (mildly) abnormal HR– $\dot{V}O_2$ relationship is usually also seen in deconditioning. In general, patients with heart failure manifest

TABLE 18. USUAL CARDIOPULMONARY EXERCISE RESPONSE PATTERNS

Measurement	Heart Failure	COPD	ILD	Pulmonary Vascular Disease	Obesity	Deconditioned
$\dot{V}O_2$ max or $\dot{V}O_2$ peak	Decreased	Decreased	Decreased	Decreased	Decreased for actual, normal for ideal weight	Decreased
Anaerobic threshold	Decreased	Normal/decreased/indeterminate	Normal or decreased	Decreased	Normal	Normal or decreased
Peak HR	Variable, usually normal in mild	Decreased, normal in mild	Decreased	Normal/slightly decreased	Normal/slightly decreased	Normal/slightly decreased
O_2 pulse ($\dot{V}_E/MVV) \times 100$	Decreased	Normal or decreased	Normal or decreased	Decreased	Normal	Decreased
$\dot{V}_E/\dot{V}CO_2$ (at AT)	Normal or decreased	Increased	Normal or increased	Normal	Normal or increased	Normal
$\dot{V}_E/\dot{V}CO_2$ (at AT)	Increased	Increased	Increased	Increased	Normal	Normal
V_D/V_T	Increased	Increased	Increased	Increased	Normal	Normal
Pa_{O_2}	Normal	Variable	Decreased	Decreased	Normal/may increase	Normal
$P(A-a)O_2$	Usually normal	Variable, usually increased	Increased	Increased	May decrease	Normal

Definition of abbreviations: AT = Anaerobic threshold; COPD = chronic obstructive pulmonary disease; HR = heart rate; ILD = interstitial lung disease; MVV = maximal voluntary ventilation; $P(A-a)O_2$ = alveolar-arterial difference for oxygen pressure; V_D/V_T = ratio of physiologic dead space to tidal volume; \dot{V}_E = minute ventilation; $\dot{V}CO_2$ = carbon dioxide output; $\dot{V}O_2$ max = maximal oxygen uptake; $\dot{V}O_2$ peak = peak oxygen uptake.

Adapted by permission from References 3, 49, and 72.

* Decreased, normal, and increased are with respect to the normal response.

impaired heart rate responses to exercise with greater HR response to any given $\dot{V}O_2$ and with peak HR reduced as disease severity progresses (36, 470). Consequently, there is usually little or no heart rate reserve (HRR) in patients with mild heart failure, mitral valvular disease, or angina; there is usually greater HRR observed in patients with more severe heart failure. Patients with ischemic heart disease may also have an impaired HR response to exercise due to chronotropic incompetence. Abnormal heart rate recovery is an independent predictor of mortality in patients referred for exercise electrocardiography (471). The predictor value of heart rate recovery after cycle ergometry requires further evaluation. ECG and blood pressure abnormalities may also be observed (9, 10, 12).

Patients with cardiovascular diseases will often have abnormal exercise ventilatory responses, including increased \dot{V}_E at submaximal $\dot{V}O_2$ due to early and usually more severe onset of metabolic acidosis, abnormal ventilation-perfusion relationships due to low cardiac output for the metabolic rate, subclinical interstitial pulmonary edema (leading to decreased lung compliance), diastolic dysfunction, increased airway resistance (see below), and stimulation of chest wall and/or lung mechanoreceptors. Patients with chronic heart failure are more likely to experience abnormal ventilatory responses compared with patients with coronary artery disease, reflecting that chronicity rather than acute flow changes may be responsible (472).

Increased respiratory frequency and reduced V_T are frequently seen. Early exercise cessation and reduced $\dot{V}O_2$ peak are associated with a reduced peak \dot{V}_E but usually with considerable ventilatory reserve (\dot{V}_E peak/MVV). Patients with heart failure have increased airway resistance (383), breathe at rest near residual volume, and are flow limited at low work rates (Figure 8) (288, 473). Breathing at low lung volumes may lead to dynamic compression of airways and may contribute to the increased dyspnea associated with exercise. Whether inspiratory muscle weakness or increased respiratory drive and activation of expiratory muscles or some other mechanism is responsible for the adoption of this breathing strategy remains uncertain and requires more investigation (288, 473).

Importantly, there is usually no arterial desaturation or drop in Pa_{O_2} and normal $P(A-a)O_2$ in response to exercise (463). However, patients with combined cardiovascular and pulmonary disease may demonstrate abnormal $P(A-a)O_2$ and Pa_{O_2} responses (276, 443). Increases in V_D/V_T and $\dot{V}_E/\dot{V}CO_2$ due to reduced cardiac output for the metabolic rate and consequent \dot{V}/\dot{Q} abnor-

malities are frequently observed, especially in moderate to severe heart failure (62, 460, 463, 474). An abnormal $\dot{V}_E/\dot{V}CO_2$ slope (greater than 34) during exercise has been suggested as an independent predictor of mortality in patients with heart failure and often as a correlate for advanced disease (62). Interestingly, abnormal $\dot{V}_E/\dot{V}CO_2$ responses return to normal after cardiac transplantation (475). The ratio of tidal volume at peak exercise to vital capacity is usually normal. Periodic breathing during exercise has been reported in some patients (476). In general, for patients with heart failure, respiratory abnormalities, although variably contributory to exercise intolerance, are usually not exercise limiting (477). The presence of \dot{V}_E/MVV ap-

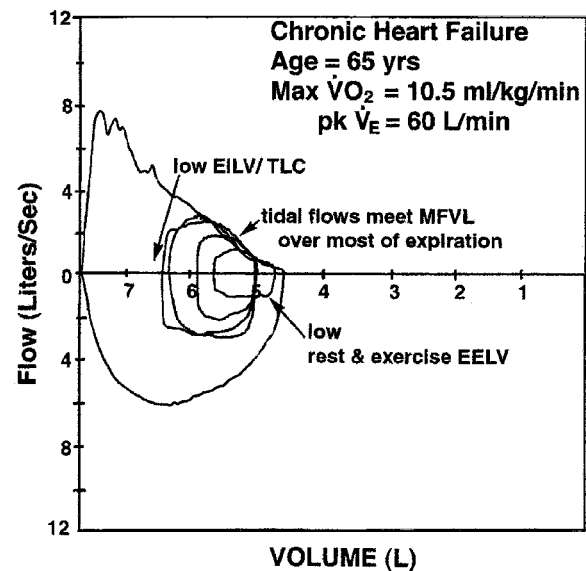

Figure 8. Example of a patient with stable congestive heart failure (New York Heart Association Class III). Shown are rest, mild, moderate, and peak exercise tidal flow-volume loops plotted within the maximal flow-volume loop. EELV is reduced at rest and remains near RV throughout exercise despite significant expiratory flow limitation and apparent room to increase EELV to avoid the flow limitation (288). EELV = end-expiratory lung volume; EILV = end-inspiratory lung volume; MFVL = maximal flow-volume loop; TLC = total lung capacity.

proaching or exceeding 100% of predicted (reduced ventilatory reserve) suggests concurrent pulmonary disease and may signal the presence of combined cardiovascular and respiratory limitation (276, 443). However, this requires additional study.

4.2. Pulmonary vascular disease. Patients with pulmonary vascular disease (primary pulmonary hypertension, pulmonary embolism, chronic thromboembolic disease, pulmonary vasculitis, etc.) will often have a reduced peak work rate and peak $\dot{V}O_2$ and are usually (but not invariably) cardiovascular limited (102, 104–106, 478, 479). The development of pathologic cardiovascular limitation may depend on several factors including extent of pulmonary vascular involvement, underlying pulmonary vascular pathology, the time course of disease progression, and, ultimately, the heart's inability to maintain adequate cardiac output in the face of increased pulmonary vascular resistance and consequent RV afterload (36, 102, 300). There is usually an early-onset metabolic acidosis. The HR– $\dot{V}O_2$ relationship is left shifted with submaximal HR values trending higher than normal and peak HR responses usually (near) normal, although low peak HR responses are seen (little/no heart rate reserve). Peak O_2 pulse is usually reduced.

The \dot{V}_E – $\dot{V}O_2$ relationship usually demonstrates increased levels of submaximal ventilation, although there is usually ventilatory reserve at peak exercise. The slope of the \dot{V}_E – $\dot{V}CO_2$ relationship is clearly abnormal. An abnormal breathing pattern of reduced V_T and increased respiratory frequency is usually observed throughout exercise in response to a spectrum of pulmonary gas exchange abnormalities including evidence of inefficient ventilation (increased $\dot{V}_E/\dot{V}CO_2$) due to increased dead space ventilation (abnormal V_D/V_T) and arterial hypoxemia with reductions in Pa_{O_2} and abnormal widening of the $P(A-a)O_2$. Respiratory frequency increases as a result of mechanical stimulation of J receptors (169). Patients with pulmonary vascular disease and elevated right-sided heart pressures may also experience hypoxemia due to right-to-left shunting across a patent foramen ovale, which occurs in about 20% of patients.

4.3. Deconditioning. Reference values for normal subjects should be obtained from relatively sedentary persons who walk a modest amount in the course of their daily life, but who do not participate in regular aerobic exercise. Thus, fit athletes as well as those who are regular joggers or cyclists may achieve peak $\dot{V}O_2$ and anaerobic threshold values that are well above predicted. Peak $\dot{V}O_2$ is often low or at the lower limit of normal in subjects who are very deconditioned but otherwise normal. There is early-onset metabolic acidosis (low AT). There is often a left-shifted HR– $\dot{V}O_2$ relationship (increased submaximal HR responses) with a normal slope and a normal peak HR and, consequently, little or no heart rate reserve (480, 481). Peak O_2 pulse is reduced. The ventilatory response to low levels of exercise is usually normal. However, increased submaximal \dot{V}_E is observed at any level of $\dot{V}O_2$ above AT as a reflection of increased metabolic acidosis compared with normal subjects. There is usually significant ventilatory reserve. Pa_{O_2} and V_D/V_T responses are usually normal. Although $\dot{V}_E/\dot{V}CO_2$ responses may be elevated at a given $\dot{V}O_2$ above the AT because of alveolar hyperventilation, peak $\dot{V}_E/\dot{V}CO_2$ is usually normal, as is the slope of the \dot{V}_E – $\dot{V}CO_2$ relationship.

Deconditioning (relative unfit) is often difficult to distinguish from early or mild heart disease (28, 42, 48). Clinical history is extremely helpful in making this distinction, as are the changes in CPET responses to an aerobic training program with monitoring of responses ($\dot{V}O_2$, O_2 pulse, AT, HR), which may help to distinguish between these clinical entities. Deconditioning is often associated with chronic illness and should be considered as a contributing factor to exercise intolerance (138, 139, 145, 310). Deconditioning is also an important factor contributing to a

reduced $\dot{V}O_{2peak}$ and exercise intolerance in patients with mitochondrial myopathy (55, 56). Work has demonstrated that training significantly improves many exercise variables and overall exercise performance in these patients, although not to normal levels. It appears that they are deconditioned most probably because of the mitochondrial myopathy (56, 482, 483).

4.4. COPD. A spectrum of exercise response patterns can be seen in patients with COPD. Patients with moderate to severe COPD will usually experience exercise intolerance and have a reduced peak work rate and peak $\dot{V}O_2$, whereas patients with mild COPD will often have an exercise response pattern and peak $\dot{V}O_2$ similar to normal. However, altered CPET responses have been noted in some patients with mild COPD (290, 484, 485). Abnormal exercise tidal flow–volume loops with expiratory flow limitation despite otherwise “normal” CPET responses have also been reported in mild COPD (450). The slope of the $\dot{V}O_2$ –WR relationship is usually normal (486, 487).

One of the distinguishing features of many patients with moderate to severe COPD is a reduced ventilatory reserve (\dot{V}_E/MVV approaching or exceeding 100%), signaling a significant ventilatory contribution to exercise limitation (*see* Section IV,7: VENTILATION). The breathing strategy adopted by patients with moderate to severe COPD during exercise includes a respiratory frequency that is higher and a V_T that is lower compared with normal subjects at the same \dot{V}_E , an increase in EELV due to dynamic hyperinflation, and a resultant reduction in inspiratory capacity ($TLC - EELV = IC$) (Figure 7) (45, 82, 87, 288, 488, 489). Consequently, inspiratory muscle dysfunction due to the increased elastic load resulting from dynamic hyperinflation may further compromise ventilatory capacity and neuroventilatory coupling (45, 82). Blunted tidal volume and inspiratory capacity responses due to dynamic hyperinflation are associated with increased work of breathing and dyspnea (45, 75, 76, 81, 85, 87, 489). Hyperoxia ($F_{I_{O_2}} = 60\%$) has been shown to improve exercise endurance in patients with severe COPD ($FEV_1 = 31\%$), purportedly by reducing ventilatory demand, reducing end-expiratory lung volume, and relieving dyspnea (490). Importantly, exercise cessation due to leg fatigue is reported in a notable number of patients with severe COPD, along with evidence of significant ventilatory constraint (4, 5). Exercise limitation is usually multifactorial.

Although patients with moderate to severe COPD will have increased submaximal HR responses (441), peak HR is usually reduced compared with normal subjects. There is usually significant heart rate reserve, a reflection that the cardiovascular system has been relatively unstressed. In a retrospective study of patients with COPD categorized as mild, moderate, or severe, it was demonstrated that as disease severity progressed, $\dot{V}O_{2max}$ and ventilatory reserve decreased and heart rate reserve increased (491). O_2 pulse is usually (but not invariably) proportionately reduced to $\dot{V}O_{2peak}$ and may be due to a combination of factors—ventilatory limitation, deconditioning, and, possibly, hypoxemia. A reduced O_2 pulse has also been suggested as possibly reflecting the hemodynamic consequences of dynamic hyperinflation (492).

Other respiratory abnormalities include a trending of increased submaximal \dot{V}_E and inefficiency of ventilation (increased $\dot{V}_E/\dot{V}CO_2$) due to the increased dead space ventilation with abnormal V_D/V_T responses. A reduced level of alveolar ventilation due to a blunted ventilatory response to metabolic acidosis, manifested by no change or increase in Pa_{CO_2} , may be seen with moderate to severe COPD (404). It has been suggested that in advanced COPD, the likelihood of developing hypercapnia during exercise with marked \dot{V}_A/\dot{Q} abnormalities primarily reflects severe mechanical constraints on ventilation due to dynamic hyperinflation (493, 494).

In COPD, the AT response may be normal, low, or indeterminate (cannot be identified but does not mean that a metabolic acidosis is precluded) by noninvasive gas exchange criteria (see Section IV,4: ANAEROBIC THRESHOLD). Blood samples for standard bicarbonate or lactate help avoid false-positive noninvasive AT determinations that have been reported in COPD (330). Most patients with mild to moderate COPD can achieve a metabolic acidosis (316, 319) whereas others with severe COPD cannot (38, 161). A low AT may reflect deconditioning due to physical inactivity and/or skeletal muscle dysfunction (73, 159, 445) including alterations in exercise-related glutamate levels (89, 90), concomitant pulmonary vascular disease, cor pulmonale, or occult left ventricular dysfunction. Consequently, a low AT may have limited discriminatory value for interpretative purposes (i.e., distinguishing heart versus lung) in patients with COPD.

Patients with COPD usually have low P_{aO_2} values at rest. During exercise P_{aO_2} may increase, decrease, or remain the same but is more likely to be reduced in patients with moderate to severe COPD (42) (see Section IV,10: PULMONARY GAS EXCHANGE); $P(A-a)O_2$ usually increases abnormally, especially when P_{aO_2} decreases (405). Exercise desaturation occurs more frequently in patients with predominantly emphysema (495, 496) than in those with predominantly chronic bronchitis, in whom increases in P_{aO_2} may occur (405). Several mechanisms may be responsible for the arterial desaturation and increases in $P(A-a)O_2$ seen during exercise in patients with COPD. These include the impact of a fall in mixed venous O_2 on low \dot{V}/\dot{Q} lung units and shunts and hypoventilation in some patients with COPD (497) as well as diffusion limitation in some severe cases (FEV_1 , 36% predicted) (498). Arterial desaturation has been shown to be correlated to reduced diffusing capacity (271, 405). In turn, COPD patients with P_{aO_2} values that either improve or remain the same with exercise have demonstrated improvement in \dot{V}/\dot{Q} relationships (498, 499).

4.5. ILD. In interstitial lung disease a spectrum of respiratory (mechanical and pulmonary gas exchange) and cardiovascular abnormalities may be observed, which may reflect differences in disease severity and/or differences in ILD types (see below). Peak \dot{V}_{O_2} and peak WR are usually reduced in ILD (94). The $\dot{V}_E-\dot{V}_{O_2}$ relationship reveals an often impressive increase in submaximal \dot{V}_E resulting from many stimuli but largely caused by increased levels of dead space ventilation. The slope of the $\dot{V}_E-\dot{V}_{CO_2}$ relationship is also increased. A reduced ventilatory reserve (high \dot{V}_E/MVV) and ventilatory limitation to exercise are often seen, primarily reflecting deranged pulmonary mechanics (see Figure 14). In addition, many factors contribute to the increased ventilatory demand in patients with ILD including increased dead space ventilation (V_D/V_T), inefficient ventilation (\dot{V}_E/\dot{V}_{CO_2}), hypoxemia, early onset metabolic acidosis, pulmonary hypertension, lung receptors, and increased central drive (98, 99). Because of mechanical constraints on tidal volume expansion, an abnormal breathing pattern consisting of increased respiratory frequency, reduced V_T , and minimal change in EELV is seen (94, 97–99, 378, 500, 501). In severe ILD, V_T approaches IC early in exercise and thereafter \dot{V}_E increases, mostly due to fr increases alone (3, 97–99).

Exercise tidal flow–volume loop analysis in those ILD patients who stop exercise because of dyspnea reveals significant expiratory flow limitation, increased EELV, abnormal inspiratory flow loops, and less arterial desaturation compared with those who stop because of leg fatigue (Figure 9) (378). These observations require additional study (378). Dyspnea appears primarily due to blunted tidal volume expansion rather than to indices of inspiratory effort (97) compared with normal subjects. Peak V_T/VC is usually, although not invariably, normal (502, 503).

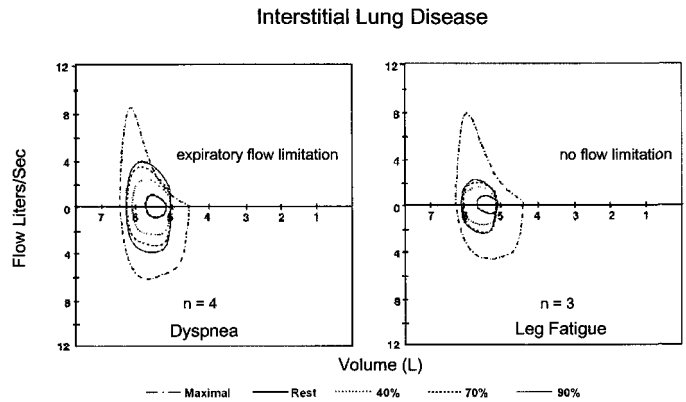

Figure 9. Maximal and extFVL in patients with ILD. *Left:* Patients who stopped secondary to dyspnea. *Right:* Patients who stopped due to leg fatigue. Minimal change was observed in EELV in either group, with the group complaining of dyspnea demonstrated significant expiratory flow limitation (modified from Marciniuk and coworkers [378]). EELV = end-expiratory lung volume; ExtFVL = exercise tidal flow–volume loop; ILD = interstitial lung disease.

At rest, patients with ILD will usually have either normal or various levels of reduced P_{aO_2} . During exercise, in most patients with significant ILD, impressive arterial desaturation and abnormal increases in $P(A-a)O_2$ are observed (29, 31, 94, 95, 504, 505). Multiple mechanisms, including \dot{V}_A/\dot{Q} mismatching, O_2 diffusion limitation, and low mixed venous P_{O_2} , have been shown to contribute to the abnormally increased $P(A-a)O_2$ (497, 504). Patients with ILD may also experience hypoxemia as a consequence of right-to-left intracardiac shunting. Arterial desaturation has been shown to be correlated with resting DL_{CO} measurements in patients with ILD (506). Although the prediction of exercise desaturation from resting DL_{CO} measurements in patients with ILD may not be consistently reliable (95, 507), patients with DL_{CO} less than 70% are more likely to desaturate (95).

Work has suggested that hypoxemia, not respiratory mechanics, appears to be the predominant factor contributing to exercise limitation during incremental exercise in patients with ILD (93, 508). In these studies, despite improvement of mean \dot{V}_{O_2} peak by about 20% with supplemental O_2 , \dot{V}_{O_2} peak was still only 67% of predicted, suggesting that exercise limitation was indeed multifactorial (93).

Inefficient ventilation (increased \dot{V}_E/\dot{V}_{CO_2} responses) due primarily to increased V_D/V_T and also hyperventilation due to hypoxemia and mechanoreceptor stimulation are usually observed throughout exercise. Hypoxemia not only contributes to the exaggerated ventilatory response, but may also contribute to reduce O_2 delivery primarily through a reduced O_2 content and also via hypoxic vasoconstriction (and the attendant increase in right ventricular afterload). P_{aCO_2} may increase, decrease, or remain the same (94). Pulmonary gas exchange abnormalities including increased V_D/V_T , reduced P_{aO_2} , and widened $P(A-a)O_2$ occur even in mild disease and may be a useful diagnostic tool for detection of early disease (48, 49).

Cardiovascular abnormalities are common and reflect pulmonary vascular and right ventricular dysfunction. The $HR-\dot{V}_{O_2}$ relationship reveals higher HR at submaximal levels of \dot{V}_{O_2} compared with normal subjects. Low peak HR responses are usually observed, especially in more severe disease. Consequently, heart rate reserve may be increased or normal. The O_2 pulse is reduced. The AT response can be normal, although a low AT commonly occurs and may be due to pulmonary circulatory and/or RV

dysfunction (O_2 delivery) and/or skeletal muscle dysfunction and deconditioning (O_2 utilization) (352).

Differences in CPET response(s) are found between different specific ILD types (31, 509). Patients with interstitial pulmonary fibrosis (IPF) experience a greater degree of arterial desaturation and abnormal pulmonary gas exchange during exercise than do patients with sarcoidosis (510) and patients with cryptogenic fibrosing alveolitis-scleroderma type (511, 512). Some investigators have suggested that patients with sarcoidosis may have disproportionate cardiovascular abnormalities due to associated left- and right-sided myocardial involvement (513–515). Additional investigation is necessary. Although patients with ILD have been traditionally thought to be ventilatory limited, a retrospective analysis has suggested that circulatory factors may be primarily exercise limiting (352). It would appear that patients with IPF (516, 517) are more likely to be circulatory limited than are those with scleroderma (478). However, this provocative concept requires additional work for IPF and for other ILD entities. The coexistence of a high \dot{V}_E/MVV (no ventilatory reserve) and cardiovascular abnormalities and limitations may signal the presence of combined exercise limitation (1).

4.6. Obesity. A spectrum of exercise responses can be seen, depending mostly on the severity of the obesity. $\dot{V}O_{2peak}$ may be reduced when expressed per kilogram of actual body weight or normal when expressed per kilogram of ideal body weight (*see* Section IV,1: OXYGEN UPTAKE). There is an excessive metabolic requirement (i.e., $\dot{V}O_2$ may be increased for a given work rate) but with a normal slope ($\Delta\dot{V}O_2/\Delta WR$) (301, 302). Resting $\dot{V}O_2$ is not appreciably different in obese subjects compared with normal subjects of the same ideal or lean weight, reflecting the relatively low metabolic rate of the adipose tissue. During cycle exercise at unloaded (0 W) pedaling $\dot{V}O_2$ increases excessively (190). The excessive metabolic requirement reflects the high-energy cost of moving the weight of the legs. Obese subjects generally cannot attain the same work rates compared with normal subjects. In the moderately obese subject, although work capacity is impaired, $\dot{V}O_{2peak}$, peak O_2 pulse, and the AT are usually normal, reflecting the “training effect” induced consequent to the demands of performing their habitual activities while “loaded” with a greater body mass. Increased HR at submaximal work rates with attainment of a (near) normal peak HR usually results in little/no heart rate reserve. Work (518) comparing obese patients with normal subjects demonstrated that the AT was reduced and that noninvasively determined cardiac index (CO_2 -rebreathing method) during exercise below the AT was lower in obese patients as compared with normal subjects. The authors postulated that obese patients might have relatively less efficient cardiac performance, relying on greater tissue extraction during exercise compared with normal subjects. In another interesting study (519), indices of left ventricular diastolic filling were measured by pulse Doppler–echocardiography in asymptomatic, morbidly obese patients and in a matched lean control group. Fifty percent of the obese patients had left ventricular diastolic filling abnormalities. The authors concluded that abnormalities of diastolic function occur frequently in asymptomatic, morbidly obese patients and that this may represent a subclinical form of cardiomyopathy.

As a result of the increased metabolic requirement, \dot{V}_E at a given external work rate is higher for obese subjects. \dot{V}_E/MVV (measured) is usually normal but may be increased in extreme obesity. However, if MVV is calculated as $FEV_1 \times 40$, the \dot{V}_E/MVV ratio may be low. This may be misleading and underestimate true ventilatory limitation. Exercise tidal flow–volume loop analysis suggests that there is (variable) ventilatory constraint due to breathing at low lung volumes and inability to increase EELV sufficiently during exercise (presumably secondary to

the increased inspiratory load), which results in expiratory flow limitation (288, 520). A “pseudo-asthma” syndrome in obese patients has been described (521).

In obesity, a breathing pattern during exercise characterized by increased respiratory rate and reduced V_T compared with normal subjects has been reported (522). This may represent an attempt to minimize the work of breathing due to the increased elastic load of excess adipose tissue. Abnormal resting Pa_{O_2} and $P(A-a)O_2$ resulting from the decrease in chest wall and lung compliances and basilar atelectasis occur (523); these abnormalities may improve as V_T increases with exercise and overall \dot{V}/\dot{Q} relationships improve. The increased \dot{V}_E and normal V_D/V_T responses may result in alveolar hyperventilation and a reduced Pa_{CO_2} with exercise. Obesity often coexists with other conditions in impacting exercise capacity. For interpretative purposes, there is value in having peak $\dot{V}O_2$ referenced to both ideal and actual body weight (*see* Section IV,1: OXYGEN UPTAKE); a significant difference would suggest that obesity may be an important contributing factor to exercise intolerance.

4.7. Psychogenic disorders: anxiety, hyperventilation syndrome. Subjects with psychogenic disorders (anxiety reactions, hysteria, panic disorders, obsessional behavior, hyperventilation syndrome, etc.) may complain of several symptoms including exertional dyspnea, chest pain, and light-headedness. These symptoms may represent unrecognized hyperventilation due to anxiety and stress (524). Often, however, there may be no apparent psychopathology (525).

Subjects with hyperventilation syndrome will often have a normal or near normal $\dot{V}O_{2peak}$ and WR. Occasionally, reduced peak $\dot{V}O_2$ and WR are observed and may reflect some other, concurrent etiology. Most importantly, abnormal breathing patterns at rest and during exercise may be revealing and, in some circumstances, almost diagnostic. CPET in these subjects often reveals impressive hyperventilation as evidenced by abnormal increases in \dot{V}_E , $\dot{V}_E/\dot{V}CO_2$, and respiratory frequency, and respiratory alkalosis (decreased PET_{CO_2} and Pa_{CO_2}) (526, 527). As an increased $\dot{V}_E/\dot{V}CO_2$ may reflect inappropriate ventilation due to either hyperventilation or excessive dead space, simultaneous arterial P_{CO_2} sampling is recommended. In contrast to the usual gradual increase in respiratory frequency seen during progressive exercise, subjects with psychogenic disorders may have an abrupt “turned on” onset of regular, rapid, shallow breathing disproportionate to the metabolic stress (49). Chronic respiratory alkalosis with a downregulated Pa_{CO_2} set point may also be observed at rest before exercise. Other symptoms (*see above*) due to respiratory alkalosis may also be elicited. Hyperventilation during exercise has been associated with ECG changes resembling ischemia in subjects with normal coronary arteries (528).

Irregular exercise breathing patterns punctuated by breath holding (noted by changes in PET_{CO_2}) and sighing have been noted in hysteria (*see* comments on nonphysiologic respiratory patterns in Section VIII,4.8: POOR EFFORT AND MALINGERING). A complete, careful history and review of systems are essential for accurate interpretation. Identification of hyperventilation syndrome is important because appropriate treatment is usually successful (524).

4.8. Poor effort and malingering. Poor effort may be suspected with early cessation of exercise and a reduced $\dot{V}O_{2peak}$, a normal or unattained AT, a low R value at exercise cessation, and substantial heart rate reserve and ventilatory reserve with no readily apparent peripheral abnormality. Malingering may be suspected when irregular, often erratic breathing patterns with intermittent hyperventilation and hypoventilation and irregular respiratory rates are noted with fluctuation in PET_{CO_2} and Pa_{CO_2} , which are unrelated to work rate. Other abnormal

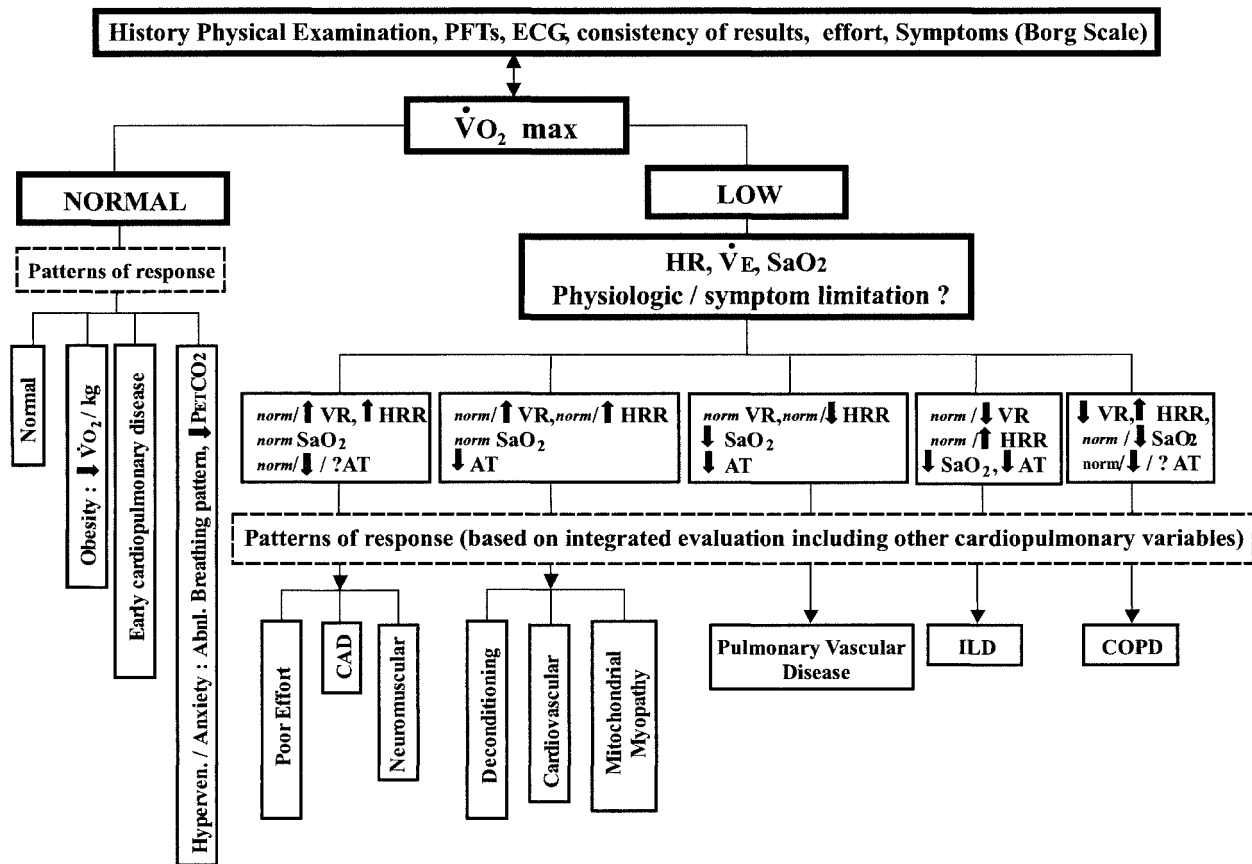

Figure 10. Basic strategy for the interpretation of peak CPET results begins with consideration of patient information and reasons for testing and with analysis of $\dot{V}O_2$ max and subsequently simultaneous assessment of HR, \dot{V}_E , and SaO_2 . The AT may be helpful at this point. Determination of physiologic limitation is accomplished by analysis of ventilatory reserve (\dot{V}_E/MVV) and heart rate reserve (HRR). Additional CPET measurements and patterns of response are established and (likely) associated clinical entities are considered, resulting in more specific diagnostic pathways (28). CAD = coronary artery disease.

respiratory pattern responses characterized by frequent sighing, panting, erratic timing, and changing FRC may be associated with intentional malingering, anxiety, and swallowing or inappropriate attempts at vocalization. Such events are common but poorly characterized in the literature. The nonphysiologic respiratory patterns are important to recognize, because they may result in inaccurate characterization of exercise variables including $\dot{V}O_2$, AT, and V_D/V_T (see discussion in Section IV: CONCEPTUAL AND PHYSIOLOGIC BASIS OF CARDIOPULMONARY EXERCISE TESTING MEASUREMENTS). Patient symptom scores may be totally disproportionate to the level of effort and exhaustion noted by the person monitoring the test. Knowledge of secondary gain is critical. In both conditions, repeat testing may be helpful in demonstrating the lack of consistent response during exercise.

5. Important Questions

With the important preliminary issues addressed, the focus is directed at key measurements, first $\dot{V}O_2$; then HR, \dot{V}_E , and SaO_2 ; and then other variables and exercise-limiting factors (cardiovascular, ventilatory, peripheral) through a series of questions aimed at providing an integrated analysis of CPET results (Figure 10). The first question is the usual starting point for interpretation.

5.1. Is aerobic capacity ($\dot{V}O_{2max}/\dot{V}O_{2peak}$) normal? A reduced $\dot{V}O_{2peak}$ has many possible causes (see Section IV,1: OXYGEN UPTAKE and Table 18), which are evaluated through re-

sponses to subsequent questioning. In turn, a normal $\dot{V}O_{2peak}$ reflects a normal aerobic capacity and provides reassurance that no significant functional impairment exists. However, in athletes and very fit subjects, a normal $\dot{V}O_{2peak}$ may be noted despite an actual significant reduction, which would not be appreciated without a previous $\dot{V}O_{2peak}$ for comparison. Clinical history including baseline physical activity determination would be helpful. A normal $\dot{V}O_{2peak}$ when referenced to ideal body weight but at a lower peak WR may also be reported in obesity (see Section VIII,4.6: OBESITY). Also, patients with early or mild heart disease and lung disease may have a normal or borderline normal $\dot{V}O_{2peak}$. Patients with gastroesophageal reflux disease may also have a normal CPET. Furthermore, although patients with psychogenic dysfunction will often have a normal or near normal $\dot{V}O_{2peak}$, CPET may reveal other abnormalities (i.e., abnormal breathing patterns) that may be of diagnostic value (49).

5.2. Is metabolic rate appropriate during exercise? The $\dot{V}O_2$ -WR relationship may reveal a metabolic requirement during exercise that is excessive (i.e., a greater amount of $\dot{V}O_2$ per given WR). A high or left-shifted $\dot{V}O_2$ -WR relationship may be seen in obesity, poor exercise technique, and hyperthyroidism (301). The resulting “exercise inefficiency,” especially with coexisting cardiopulmonary disease, frequently contributes to exercise intolerance. However, a left-shifted $\dot{V}O_2$ -WR relationship may not be readily apparent without the appropriate corresponding reference values plotted and these are therefore strongly

recommended. Although a reduced ratio of increase in \dot{V}_{O_2} to increase in work rate ($\Delta\dot{V}_{O_2}/\Delta WR$) is reported to occur in cardiovascular disease, as noted previously, this has not been consistently observed in patients with known cardiovascular disease (195) and may also be seen in some patients with mitochondrial myopathy (54) and in patients with cystic fibrosis (110). Therefore, a low $\Delta\dot{V}_{O_2}/\Delta WR$ may be useful in identifying an abnormal relationship but relatively nonspecific in establishing etiology (i.e., O_2 delivery versus O_2 utilization dysfunction). This is important for interpretative purposes in appropriate clinical scenarios (i.e., unexplained exertional dyspnea) (51). Additional work is required to establish the sensitivity and specificity of $\Delta\dot{V}_{O_2}/\Delta WR$ and its discriminatory ability.

5.3. Does cardiovascular function contribute to exercise limitation? Achievement of age-predicted values for maximal HR during exercise is often used as a reflection of maximal or near maximal effort, presumably signals attainment of \dot{V}_{O_2max} and maximal cardiac output, and, furthermore, suggests that cardiovascular function contributes to exercise limitation. This is the usual situation in normal subjects when \dot{V}_{O_2max} predicted is achieved (see Section VI: NORMAL INTEGRATIVE EXERCISE RESPONSE). However, when exercise stops at a low \dot{V}_{O_2} but with a normal predicted HR, abnormal cardiovascular function and/or O_2 content factor (anemia, hypoxemia, or carboxyhemoglobin) and/or O_2 utilization (skeletal muscle dysfunction) is contributing to exercise limitation. This low peak \dot{V}_{O_2} –normal peak heart rate pattern may be seen in several different clinical entities including early or mild heart disease, mitral valve disease, pulmonary vascular disease, coronary artery disease, deconditioning, obesity, early/mild lung disease with or without hypoxemia, and mitochondrial myopathy.

Clearly, determining which of these entities is most likely requires the integration of additional exercise responses, both normal and abnormal, so that patterns of responses can be established and, when considered within a clinical setting framework, linked to appropriate clinical entities. For instance, an accompanying abnormal ECG, chest pain, and abnormal BP responses would favor coronary artery disease.

In a physically active individual with relatively recent onset exertional dyspnea, normal PFTs including a negative methacholine challenge, an unremarkable ECG, normal baseline laboratory studies, and reduced exercise tolerance, a low peak \dot{V}_{O_2} –normal peak HR pattern when accompanied by a low AT, low O_2 pulse, and a normal \dot{V}_E/MVV might be more suggestive of early/mild cardiovascular disease rather than deconditioning. However, without the clinical history, it would be more difficult to distinguish between these two entities. The differential diagnosis would most probably also include consideration of much less commonly encountered entities, that is, some mitochondrial myopathy in which a hyperdynamic, hyperventilatory pattern with a low O_2 pulse and low AT may also be seen (52, 54, 55). Although the AT is often low in patients with cardiovascular disease, it has limited discriminatory ability, as it is also low in deconditioning, mitochondrial myopathy, as well as other conditions. The AT is useful, however, in providing internal consistency to the integrated exercise responses.

A low peak \dot{V}_{O_2} –normal peak HR pattern would also include pulmonary vascular disease (PVD). Compared with early/mild cardiovascular disease and deconditioning, pulmonary vascular disease is more likely associated with abnormal \dot{V}_E/\dot{V}_{CO_2} , V_D/V_T , Pa_{O_2} , and $P(a-a)O_2$ responses. Although abnormal \dot{V}_E/\dot{V}_{CO_2} and V_D/V_T responses without desaturation are seen in patients with moderate to severe heart failure, the peak HR response in heart failure is highly variable, usually decreasing as disease severity increases (36). In turn, early or mild heart disease usually is associated with near normal peak HR.

If predicted peak HR is not achieved and the \dot{V}_{O_2} is low, cardiac limitation due to coronary artery disease, peripheral vascular disease, chronotropic dysfunction, or noncardiovascular limitation to exercise is possible. The noncardiovascular causes include poor effort, lung disease, drug-induced (β -blockers) and peripheral factors related to muscles, and neuromuscular or arthritic abnormalities.

5.4. Does ventilatory function (respiratory mechanics) contribute to exercise limitation? One of the most challenging tasks in the interpretation of CPET result relates to the assessment and influence of ventilatory limitation (or constraint) on exercise limitation. Assessing the degree of ventilatory constraint (limitation) has traditionally been based on the “ventilatory reserve,” defined as peak \dot{V}_E/MVV or peak $\dot{V}_E - MVV$, or as the relation between ventilatory demand represented by \dot{V}_{Epeak} and ventilatory capacity estimated by MVV . Significant controversy, however, surrounds this practice in part because of a lack of definitive measurement of ventilatory capacity (see extensive discussion in Section IV,7: VENTILATION). Although emerging technologies, in particular exercise tidal flow–volume loops referenced to maximal flow–volume loops, have provided additional valuable insight into how mechanical constraints limit exercise (Figures 5–9), clinical validation in different clinical settings is required (288). For the future, continued use of \dot{V}_E/MVV and the unique visual assessment provided by extFVL/MFVL may be useful together. Alternatively, the role of negative expiratory pressure applied while monitoring the exercise tidal flow–volume loops may provide additional insight (380). Additional investigation is required.

Consequently, peak \dot{V}_E/MVV , as an indirect index of ventilatory constraint, is practical and empirically useful. A high peak \dot{V}_E/MVV (or low/no ventilatory reserve) typically, but not invariably (see below), signals the presence of a pulmonary problem (485). In severe COPD, the peak \dot{V}_E/MVV usually approaches or exceeds 100%, whereas in mild COPD, it may be normal with significant ventilatory constraint apparent only with extFVL/MFVL analysis (450, 491). In moderate COPD, the peak \dot{V}_E/MVV may approximate the upper normal 95% CI (about 85%), but may not approach 100%. Ventilatory constraint contributing to exercise limitation may be clinically suspected if other respiratory abnormalities known to increase ventilatory requirements during exercise are present (see Section VIII,4.4: COPD). In this situation, extFVL/MFVL analysis might be helpful (Figure 7). In patients with ILD, the peak \dot{V}_E/MVV is usually higher than normal but usually not as high as in COPD (378). Ventilatory constraint to exercise limitation due primarily to mechanical derangements and other factors increasing ventilatory requirements may be a function of type and severity of ILD (see Section VIII,4.5: ILD). Active investigation of this topic is underway presently.

Importantly, the peak \dot{V}_E/MVV is usually normal in cardiovascular disease and, as such, is helpful in distinguishing heart from lung disease in patients with both abnormal cardiovascular and respiratory exercise responses. In patients with a low \dot{V}_{O_2} , low O_2 pulse, low AT, and either a normal or reduced heart rate reserve, the associated findings of abnormal ECG changes, no drop in Pa_{O_2} or Sa_{O_2} , and a normal peak \dot{V}_E/MVV reinforce the likelihood of a cardiovascular etiology (see Section VIII,4.1: HEART FAILURE). In turn, the presence of a reduced or absent ventilatory reserve (peak $\dot{V}_E/MVV > 100\%$) in patients with a clinical profile and exercise response pattern containing cardiovascular and respiratory abnormalities may signal the presence of combined cardiovascular and ventilatory limitation (276, 443). Likewise, patients with ILD can have exercise response patterns reflecting combined pulmonary vascular and ventilatory limitation to exercise (\dot{V}_E/MVV , about 90–100%). Interval evaluation

for disease progression may establish the prevailing predominant exercise-limiting factor (1).

The peak \dot{V}_E/MVV is usually normal in deconditioning but may exceed or approach 100% in athletes, a reflection that \dot{V}_{O_2} max predicted has been reached or exceeded (529). In contrast, when peak \dot{V}_E/MVV is greater or equal to 100% in patients, the \dot{V}_{O_2} peak is usually reduced. Measured ventilatory reserve is usually normal or increased (peak \dot{V}_E/MVV is normal or low) in patients with neuromuscular disorders. Often, however, the calculated MVV ($FEV_1 \times 40$) is significantly greater than the actual measured MVV. The disparity in ventilatory reserve should raise suspicion for neuromuscular disease. The spectrum of neuromuscular abnormalities, however, may be wide, reflecting different pathophysiologies (42, 530). Patients with apparent predominantly peripheral exercise limitation (e.g., status post lung and heart–lung transplantation) will have a low \dot{V}_{O_2} , low O_2 pulse, low AT, low R, and significant ventilatory reserve (low peak \dot{V}_E/MVV) and HRR at end exercise (138, 139, 145). Finally, poor effort is suspected when reduced \dot{V}_{O_2} peak is associated with high ventilatory reserve (low \dot{V}_E/MVV) and HRR and a low R without apparent peripheral problems (see Section VIII,4.8: POOR EFFORT AND MALINGERING).

5.5. Does pulmonary gas exchange (hypoxemia, inefficient ventilation, increased dead space ventilation) contribute to exercise limitation? Exercise hypoxemia most often reflects intrinsic lung disease, pulmonary vascular disease, and, less frequently, intracardiac left-to-right shunts (see Section IV,10: PULMONARY GAS EXCHANGE; Section VIII,4.2, PULMONARY VASCULAR DISEASE; Section VIII,4.4, COPD; and Section VIII,4.5: ILD). A fall in Sa_{O_2} (ΔSa_{O_2}) of $\geq 4\%$, $Sa_{O_2} \leq 88\%$, or $Pa_{O_2} \leq 55$ mm Hg during CPET is usually considered clinically significant (13, 25). As such, exercise desaturation occurs in most patients with ILD, pulmonary vascular disease, in many patients with COPD, and in elite athletes (396). Furthermore, supplemental O_2 administered during exercise has been shown to significantly improve exercise performance in these patients (74, 93). Although the exact mechanism of action of O_2 in improving exercise performance in these populations is not yet fully understood (i.e., increased transport of O_2 to the exercising muscles, reduced hypoxic drive to breathe, reduced dyspnea, improved cardiovascular function), it is apparent that hypoxemia significantly contributes to limit exercise performance in those patients who become hypoxemic during exercise.

Hypoxemia is a significant contributor to exercise limitation in both pulmonary vascular disease and ILD. However, the distinction between ILD and pulmonary vascular disease is often difficult, as there may be significant overlap in several cardiovascular, metabolic, ventilatory, and pulmonary gas exchange exercise responses (see Table 18). The clinical profile (history, physical examination, chest X-ray, high-resolution and/or spiral computed tomography scan, etc.) is often critical. Importantly, hypoxemia is usually not seen in patients with anemia, carboxyhemoglobin, deconditioning, obesity, heart failure, or mitochondrial myopathy.

Inefficiency of ventilation as reflected in abnormal \dot{V}_E/\dot{V}_{CO_2} responses during exercise results from either increased dead space ventilation (V_D/V_T) due to ventilation–perfusion imbalance and/or relative alveolar hyperventilation. The latter can be caused by increased central drive, increased mechanoreceptor activity, or hypoxemia and is evidenced by a reduced Pa_{CO_2} . Patients may be subject to each of the two major causes, with the predominant effect usually defined by the Pa_{CO_2} . Abnormal exercise \dot{V}_E/\dot{V}_{CO_2} responses are observed in patients with cardiovascular disease, respiratory disease, and mitochondrial myopathy, and in subjects with psychogenic dysfunction (hyperventilation syndrome, anxiety, etc.).

Importantly, an abnormal \dot{V}_E/\dot{V}_{CO_2} response may signal the need to obtain arterial blood gases during exercise, so that Pa_{CO_2} and V_D/V_T can be determined directly (see Section III,3: EXERCISE TEST WITH ARTERIAL BLOOD SAMPLING). This may be helpful in more definitively establishing hyperventilation without intrinsic lung disease versus abnormal dead space ventilation.

Although abnormal \dot{V}_E/\dot{V}_{CO_2} responses are found in several clinical entities, it is likely that in COPD and ILD its impact on exercise limitation is most directly realized. In patients with COPD, abnormal \dot{V}_E/\dot{V}_{CO_2} responses are usually due to increased V_D/V_T , although other causes—hypoxemia, mechanoreceptor stimulation, cor pulmonale, and so on—and other abnormal respiratory exercise responses may coexist. These factors all contribute to an increased ventilatory requirement for exercise, which adversely affects the ventilatory demand/capacity relationship and may result in a reduced ventilatory reserve. The slope of the \dot{V}_E – \dot{V}_{CO_2} relationship is an independent prognostic indicator of poor outcome in patients with heart failure (62).

5.6. Is there premature metabolic acidosis? Early onset metabolic acidosis manifested by a low AT is commonly seen in patients with COPD, ILD, pulmonary vascular disease, heart failure, mitochondrial myopathy, and deconditioning. Because finding a low AT is not specific to any one disease or group of diseases, its role as a discriminatory variable is limited. However, the AT may be useful in interpretative schemes when used in conjunction with other variables to corroborate patterns of response with different clinical entities and to establish consistency among the measurements. Finding a low AT is evidence of abnormal oxygen delivery to working muscles and/or intrinsic muscle abnormalities. In situations in which the AT measured noninvasively is undetermined or questionable (see Section IV,4: ANAEROBIC THRESHOLD) and the detection or quantification of metabolic acidosis is needed, blood samples for lactate or standard bicarbonate are recommended (269, 330).

6. Putting It All Together

The final portion of the integrative approach to CPET interpretation involves identifying patterns of exercise responses and limitations, consideration of which clinical entities may be associated with these patterns (see Table 18 and Figure 10), and correlating these results with the patient's clinical status profile. Interpretation of CPET results is more complex than the earlier simplistic explanations and schemes would have us believe. However, the approach described herein should provide the basis for more rigorous clinically tested interpretative schemes for the future. For instance, although a “patterns-based” approach is flexible and theoretically attractive, relatively few studies have evaluated the sensitivity, specificity, and positive predictive value of patterns of exercise responses in diagnosing and distinguishing different clinical entities. Moreover, the impact of this approach on clinical decision making in well-established clinical entities remains incompletely characterized. For the future, studies addressing the use of likelihood ratios (531) might be even more useful to clinicians. The application of Bayesian analysis to CPET results, similar to approaches used for coronary artery disease and, more recently, in bronchoprovocation testing, may also prove to be helpful (24). To the extent possible, the paradigm shift to an evidenced-based approach (532) for CPET interpretation will, hopefully, provide important answers to clinically relevant questions that are not immediately available.

7. Case Studies

The integrative approach to the interpretation of CPET results is highlighted in the following case studies. The cases that have been selected reflect common clinical situations. In addition to the exercise response data, appropriate baseline clinical and

TABLE 19. RESULTS OF MAXIMAL CARDIOPULMONARY EXERCISE TESTING FOR A HEALTHY PERSON

62-year-old male; white; height, 175 cm; weight, 84 kg; ideal weight, 78 kg
 Clinical Dx: Exertional dyspnea
 Medications: None
 Reason for testing: Shortness of breath on exertion

Resting Pulmonary Function Tests					
Variable	Actual	% Pred	Variable	Actual	% Pred
FVC, L	4.50	99	TLC, L	6.52	103
FEV ₁ , L	3.10	88	RV, L	2.54	109
FEV ₁ /FVC, %	69		DL _{CO} , ml/min per mm Hg	26.3	91
MVV, L/min	124				

Cardiopulmonary Exercise Test					
Protocol: Maximal, symptom limited, incremental cycle ergometry, 30 W/min					
P _B , 722 mm Hg; P _{I_{O₂}, 142 mm Hg}					
Variable	Peak	% Pred	Variable	Rest	Peak
Work rate, W	170	109	Sa _{O₂} , %		
\dot{V} O ₂ , L/min	2.1	98	Sp _{O₂} , %	95	96
\dot{V} O ₂ , ml/kg per min	25.6	91	Pa _{O₂} , mm Hg		
AT, L/min	1.05	N (> 0.86)	Pa _{CO₂} , mm Hg		
$\Delta\dot{V}$ O ₂ / Δ WR, ml/min/W	10.3	N (> 8.6)	pH		
HR, beats/min	166	98	HCO ₃ ⁻ , mEq/L		
O ₂ pulse, ml/beat	12.6	100	P(A-a)O ₂ , mm Hg		
BP, mm Hg	176/90		V _D /V _T		
\dot{V} E, L/min	90.7	73	Lactate, mEq/L		
fr, breaths/min	33	N			
\dot{V} E/ \dot{V} CO ₂ , at AT	34	N			
RER	1.21				

Stop: Dyspnea, 7/10; leg fatigue, 5/10

Definition of abbreviations: AT = anaerobic threshold; BP = blood pressure; DL_{CO} = diffusing capacity of the lung for CO; fr = respiratory frequency; H = high; HR = heart rate; L = low; MVV = maximal voluntary ventilation; N = normal; P(A-a)O₂ = alveolar-arterial difference for oxygen pressure; RER = respiratory exchange ratio; RV = residual volume; Sa_{O₂} = arterial oxygen saturation; Sp_{O₂} = arterial oxygen saturation as indicated by pulse oximetry; TLC = total lung capacity; \dot{V} CO₂ = carbon dioxide output; V_D/V_T = ratio of physiologic dead space to tidal volume; \dot{V} E = minute ventilation; \dot{V} O₂ = oxygen uptake; WR = work rate.

laboratory data are presented to enhance the physiologic-clinical correlation. For practical purposes, interpretation of these case studies was accomplished with information provided in Tables 10, 11, and 14-18 and Figure 10.

The contribution of the exercise results in the clinical decision-making process is emphasized. The data are formatted for both tabular and graphic analysis as previously described (see Section VIII,3.4: MEASUREMENTS AND GRAPHIC INTERRELATIONSHIPS and Section VIII,3.6: DATA PRESENTATION), using maximal predicted values from one of the more widely used sets of reference standards (235) (Table 15). Multiple sources (43, 190, 235, 455) were used to provide the comparative normal responses for the graphic representation of the submaximal exercise. A cautionary note is offered, as this remains rather empiric. The selection of a particular method of analysis for each variable, however, was consistently applied in all patients. Suggested criteria for normal maximal values for interpretation of CPET results obtained from several sources appear in Table 17. The reader is cautioned that Table 17 is intended to provide guideline values that are (at least for some variables) approximations of normality. Evidence-based criteria are necessary. The case reports provide component features necessary (or helpful) for inclusion in the final exercise report. Exercise interpretation is limited to CPET results generated during maximal incremental cycle ergometry.

Finally, the reader is reminded that for the interpretation of pulmonary gas exchange, cases 1 and 4 were performed at sea level (P_{I_{O₂} = 142 mm Hg) and cases 2, 3, and 5 were performed with a mean barometric pressure of 656 mm Hg (P_{I_{O₂} = 128 mm Hg).}}

Case study 1: normal CPET response.

Clinical history. A 62-year-old white male, lifelong non-smoker with an unremarkable past medical history and physical examination, normal chest X-ray, resting electrocardiogram, and screening laboratory work, was referred for CPET because although physically active, he perceives that he has been experiencing increased exertional shortness of breath over the last 6 months. A friend recently died of a heart attack. Anthropomorphic data, PFTs, and peak exercise results appear in Table 19 with graphic data appearing in Figure 11.

Interpretation. PFTs are within normal limits.

Exercise. Maximal effort was evidenced by work rate, \dot{V} O₂, and O₂ pulse responses approaching/exceeding maximal predicted values and RER = 1.21. Exercise stopped due to leg fatigue (7/10) and dyspnea (5/10). There was normal aerobic capacity and a normal \dot{V} O₂-WR relationship (Figure 11A). The HR- \dot{V} O₂ relationship was within normal limits (WNL) (Figure 11B); there was no heart rate reserve at peak exercise, consistent with a normal cardiovascular limitation to exercise (Figure 11B). The O₂ pulse plateaued appropriately (Figure 11B). Twelve-lead ECG and blood pressure responses were WNL. In general, cardiovascular responses to exercise were WNL. The anaerobic threshold was normal using either the V-slope method (Figure 11C) or ventilatory equivalents method (Figures 11F, 11I). The \dot{V} E- \dot{V} O₂ relationship was within normal limits with normal ventilatory reserve (peak \dot{V} E/MVV) at peak exercise (Figure 11G). An overall normal pattern of respiratory responses, including normal responses of V_T and fr, was observed (Figure 11E). The slope of the \dot{V} E- \dot{V} CO₂ relationship was WNL (Figure 11D). PET_{CO₂}

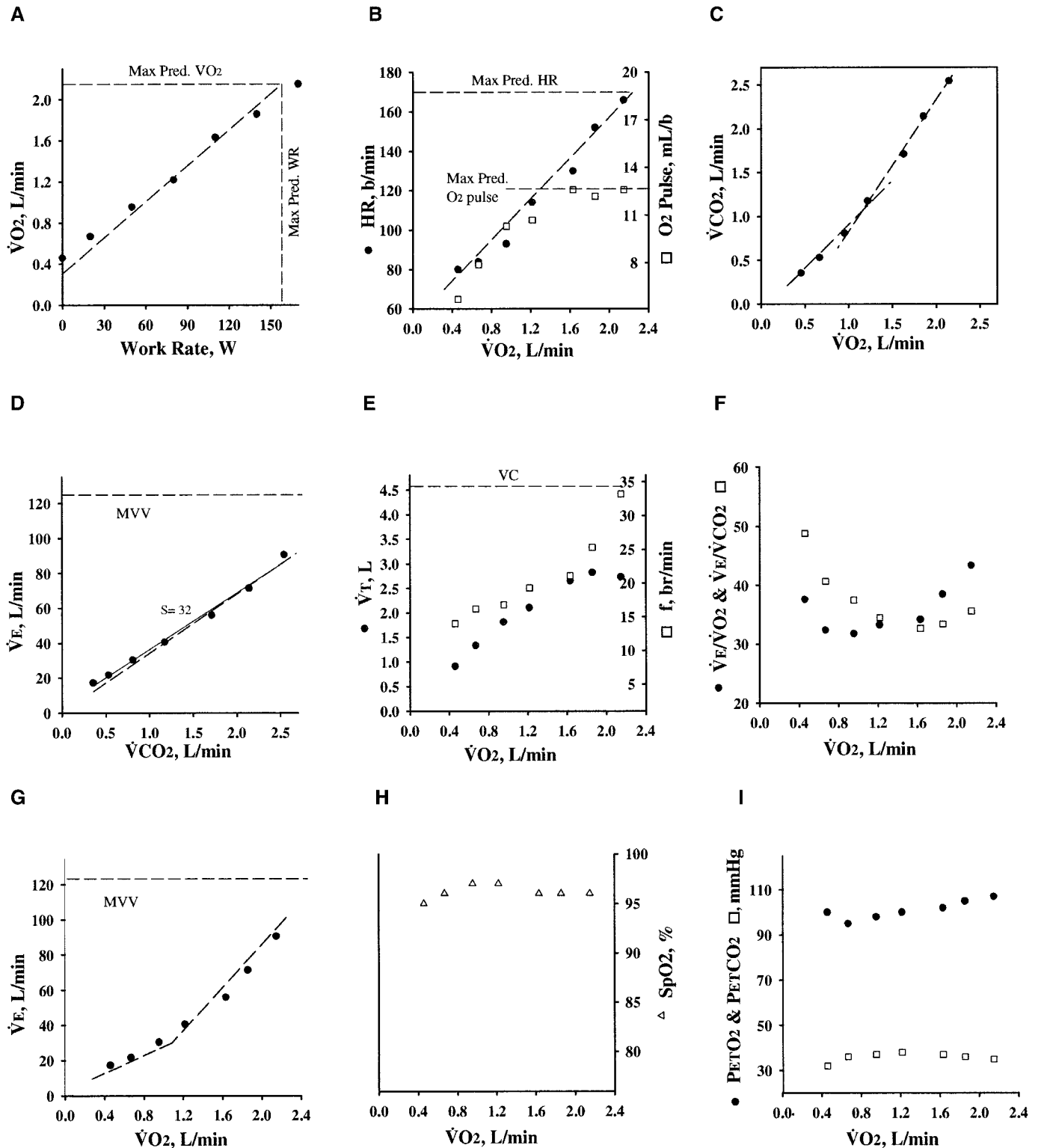

Figure 11. Graphic representation of the maximal, incremental, cardiopulmonary exercise response of a healthy aged person. These graphic data are averaged over an interval of 1 minute. The results (symbols) are compared with calculated reference values obtained from several sources (dashed lines). (A) Oxygen uptake ($\dot{V}O_2$) versus work rate; (B) heart rate (HR) and O₂ pulse versus $\dot{V}O_2$; (C) indirect determination of the anaerobic threshold (AT), using the modified V-slope method, in which carbon dioxide production ($\dot{V}CO_2$) is plotted versus $\dot{V}O_2$; (D) minute ventilation (\dot{V}_E) versus carbon dioxide output ($\dot{V}CO_2$); (E) tidal volume (\dot{V}_T) and respiratory frequency (f_R) versus $\dot{V}O_2$; (F) ventilatory equivalent for O₂ ($\dot{V}_E/\dot{V}O_2$), ventilatory equivalent for CO₂ ($\dot{V}_E/\dot{V}CO_2$) versus $\dot{V}O_2$; (G) minute ventilation (\dot{V}_E) versus $\dot{V}O_2$; (H) pulse oximetry (SpO₂) versus $\dot{V}O_2$; (I) end-tidal pressure for O₂ (PET_{O₂}) and end-tidal pressure for CO₂ (PET_{CO₂}) versus $\dot{V}O_2$. Graphs F and I are also used for the determination of the AT using the ventilatory equivalents method. (Case courtesy of Darcy Marciniuk, M.D.)

TABLE 20. RESULTS OF MAXIMAL CARDIOPULMONARY EXERCISE TESTING FOR A PATIENT WITH CARDIOMYOPATHY*

49-year-old female; white; height, 163 cm; weight, 52.6 kg; ideal weight, 63.1 kg
 Clinical Dx: Severe dilated cardiomyopathy
 Medications: Carvedilol, lisinopril, Lasix, KCl, Coumadin, Paxil, cerivastatin, Premarin, Pepcid
 Reason for testing: Evaluation for heart transplantation.

Resting Pulmonary Function Tests					
Variable	Actual	% Pred	Variable	Actual	% Pred
FVC, L	3.44	96	TLC, L	5.08	100
FEV ₁ , L	2.39	85	RV, L	1.61	102
FEV ₁ /FVC, %	70		DL _{CO} , ml/min per mm Hg	10.5	46
MVV, L/min	129	128			

Cardiopulmonary Exercise Test					
Protocol: Maximal, symptom limited, incremental cycle ergometry, 20 W/min					
P _B , 656 mm Hg; P _{lO₂} , 128 mm Hg					
Variable	Peak	% Pred	Variable	Rest	Peak
Work rate, W	80	88	Sa _{O₂} , %	96	95
$\dot{V}O_2$, L/min	0.83	60	Sp _{O₂} , %	95	85
$\dot{V}O_2$, ml/kg per min	15.8	60	Pa _{O₂} , mm Hg	77	84
AT, L/min	0.60	L (> 0.76)	Pa _{CO₂} , mm Hg	35	30
$\Delta\dot{V}O_2/\Delta WR$, ml/min/W	5.1	L (> 8.6)	pH	7.451	7.346
HR, beats/min	166	94	HCO ₃ ⁻ , mEq/L	24	17
O ₂ pulse, ml/beat	5.0	64	P(A-a)O ₂ , mm Hg	13	20
BP, mm Hg	174/87		V _D /V _T	0.43	0.33
\dot{V}_E , L/min	47	36	Lactate, mEq/L	0.7	7.9
f _R , breaths/min	37	N			
$\dot{V}_E/\dot{V}CO_2$, at AT	37	H			
RER	1.28				

Stop: Dyspnea, 3/10; leg fatigue, 4–5/10

Definition of abbreviations: See Table 19.

and PET_{O₂} responses were also WNL (Figure 11I). Sp_{O₂} trended normally during exercise (Figure 11H). $\dot{V}_E/\dot{V}O_2$ and $\dot{V}_E/\dot{V}CO_2$ responses were normal (Figure 11F).

Conclusion. Normal cardiovascular limitation to exercise. Normal aerobic capacity and level of fitness.

Comment. The patient was reassured that there were no functional abnormalities that could be detected. Subsequent follow-up has confirmed the absence of any significant pathology.

Case contributed by Darcy Marciniuk, M.D.

Case study 2: CPET in a patient with dilated cardiomyopathy.

Clinical history. A 49-year-old white female with recently diagnosed severe dilated cardiomyopathy and nonobstructive coronary arteries, with left ventricular ejection fraction of less than 25%, apical left ventricular thrombus, severe left ventricular hypokinesis, and moderate to severe pulmonary hypertension (systolic/diastolic, 68/32 mm Hg; mean, 45 mm Hg) was referred for CPET as part of a cardiac transplantation evaluation. In the previous 8–12 months, she had experienced increasing dyspnea on exertion, progressive generalized weakness/fatigue, and a 9-kg weight loss. She denied chest pain. Review of systems was positive for a history of gastroesophageal reflux and hypercholesterolemia. There was a 45 pack-year smoking history and alcohol ingestion of three to four drinks nightly that stopped 5 months previously. Present medications included the following: lisinopril (20 mg), furosemide (Lasix; 40 mg), carvedilol (6.25 mg), warfarin (Coumadin; 4.5 mg), cerivastatin (4 mg), Premarin (1.25 mg), Pepcid (40 mg), Paroxetine (20 mg), and KCl (10 mEq). Anthropomorphic data, PFTs, and peak exercise results appear in Table 20 with graphic data appearing in Figure 12.

Interpretation. Spirometry and lung volumes are WNL. DL_{CO} is severely reduced. This has been previously reported in patients with cardiovascular disease.

Exercise. Because of the 45-pack-year smoking history, severely reduced DL_{CO}, and uncertain reliability of pulse oximetry

in patients with heart failure, an invasive CPET (indwelling arterial line) was performed. Maximal effort was evidenced by achieving a peak HR of 94%, an RER of 1.28, and clinically looking truly exhausted at peak exercise. Exercise stopped because of leg fatigue (5/10) and dyspnea (3/10). There was a moderate reduction in $\dot{V}O_{2peak}$, which was associated with several other abnormalities including early plateauing of the $\dot{V}O_2$ -work rate relationship (Figure 12A), low $\Delta\dot{V}O_2/\Delta WR$ (Figure 12A), and a reduced O₂ pulse (Figure 12B); the O₂ pulse- $\dot{V}O_2$ relationship suggested an “early plateau” effect (Figure 12B). The HR- $\dot{V}O_2$ relationship was left shifted (rise in HR at submaximal $\dot{V}O_2$) (Figure 12B). Exercise was cardiovascular limited as there was no heart rate reserve (less than 15 beats) at peak exercise. There were no abnormal blood pressure responses, with nonspecific ST-T changes noted on ECG. Early onset metabolic acidosis was evidenced by a low anaerobic threshold graphically determined (for didactic purposes) by three different methods: measurements of arterial lactate (Figure 12I), V-slope (Figure 12C), and ventilatory equivalents (Figure 12F). This pattern of abnormalities is consistent with patients with cardiovascular disease. Early onset metabolic acidosis (low AT) in this patient is consistent with decreased O₂ delivery due to cardiovascular disease but could also reflect deconditioning and/or skeletal muscle dysfunction.

There was plenty of ventilatory reserve at peak exercise ($\dot{V}_E/MVV = 36\%$) (Figure 12D). Abnormal ventilatory responses were observed including excessive ventilation for the metabolic requirement throughout exercise as manifested by an abnormal slope of the \dot{V}_E -versus- $\dot{V}CO_2$ relationship (slope = 44, 95% CI < 34) (Figure 12D), an abnormal \dot{V}_E -versus- $\dot{V}O_2$ relationship (not shown) and increased values for $\dot{V}_E/\dot{V}CO_2$ and $\dot{V}_E/\dot{V}O_2$ throughout exercise (Figure 12F). Multiple factors are presumably responsible for increased submaximal ventilation including early onset metabolic acidosis, inefficient ventilation, increased dead space

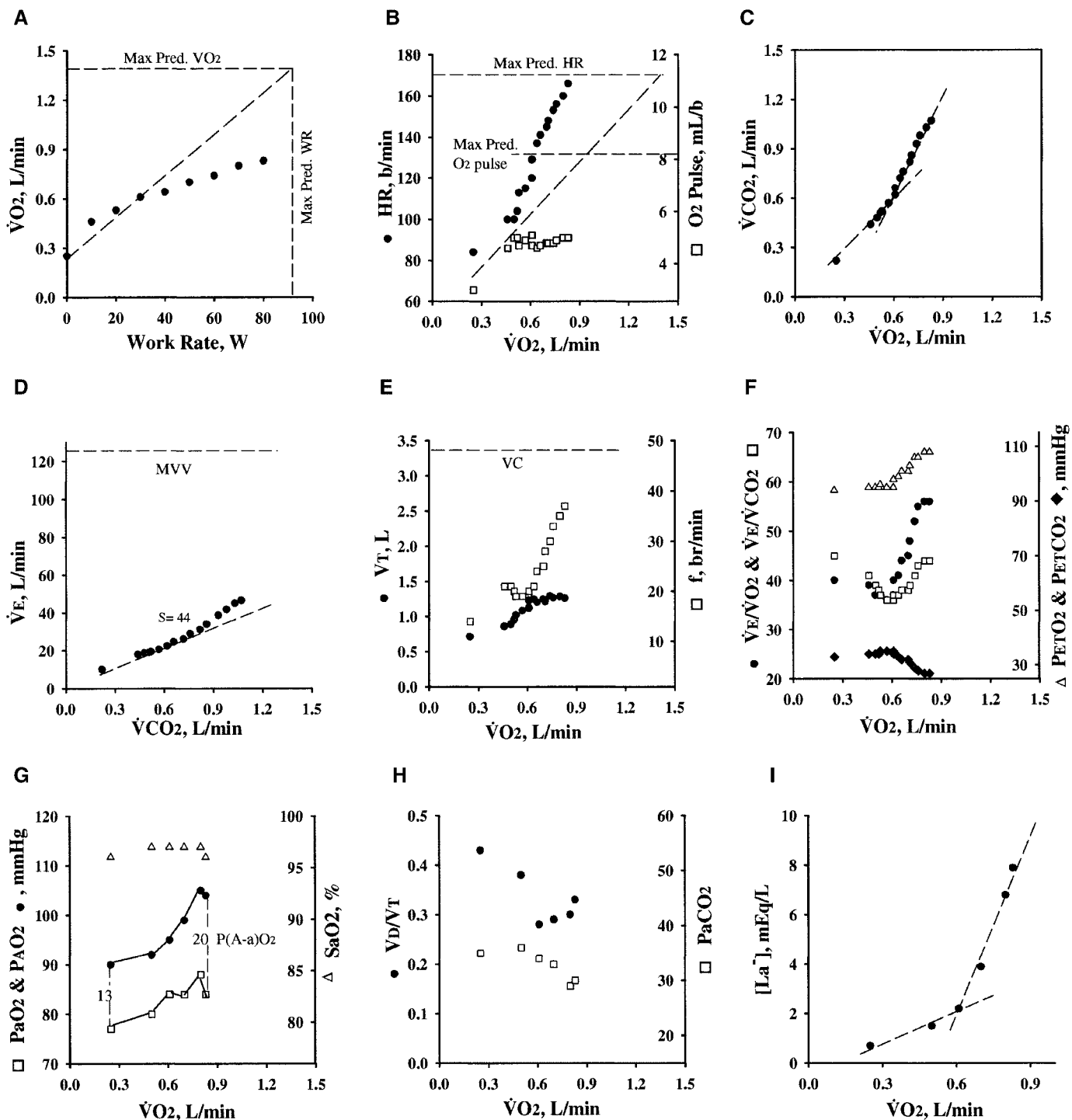

Figure 12. Graphic representation of the maximal, incremental, cardiopulmonary exercise response of a patient with cardiomyopathy. These graphic data are averaged over an interval of 30 seconds. The results (symbols) are compared with calculated reference values obtained from several sources (dashed lines). (A) Oxygen uptake ($\dot{V}O_2$) versus work rate; (B) heart rate (HR) and O₂ pulse versus $\dot{V}O_2$; (C) indirect determination of the anaerobic threshold (AT), using the modified V-slope method, in which carbon dioxide production ($\dot{V}CO_2$) is plotted versus $\dot{V}O_2$; (D) minute ventilation ($\dot{V}E$) versus carbon dioxide output ($\dot{V}CO_2$); (E) tidal volume (V_T) and respiratory frequency (fr) versus $\dot{V}O_2$; (F) ventilatory equivalent for O₂ ($\dot{V}E/\dot{V}O_2$), ventilatory equivalent for CO₂ ($\dot{V}E/\dot{V}CO_2$), end-tidal pressure for O₂ (PET_{O₂}), and end-tidal pressure for CO₂ (PET_{CO₂}) versus $\dot{V}O_2$. Graph F is also used for the determination of the AT, using the ventilatory equivalents method. (G) Alveolar O₂ pressure (PA_{O₂}), arterial O₂ pressure (Pa_{O₂}), alveolar-arterial O₂ pressure difference [P(A-a)O₂], and arterial O₂ saturation (Sa_{O₂}) versus $\dot{V}O_2$; (H) physiologic dead space-to-tidal volume ratio (V_D/V_T) and arterial CO₂ tension (PaCO₂) versus $\dot{V}O_2$; (I) determination of the AT using the plot of arterial lactate versus $\dot{V}O_2$. (Case courtesy of Idelle M. Weisman, M.D.)

TABLE 21. RESULTS OF MAXIMAL CARDIOPULMONARY EXERCISE TESTING FOR A PATIENT WITH CHRONIC OBSTRUCTIVE PULMONARY DISEASE

66 year-old male; white; height, 175 cm; weight, 61 kg; ideal weight,: 77.5 kg
 Clinical Dx: Severe COPD
 Medications: Ipratropium bromide, budesonide, salmeterol, as-needed Proventil, Tagamet
 Reason for testing: Evaluation of functional capacity and worsening of dyspnea

Resting Pulmonary Function Tests					
Variable	Actual	% Pred	Variable	Actual	% Pred
FVC, L	2.44	55	TLC, L	9.45	139
FEV ₁ , L	0.88	25	RV, L	7.01	303
FEV ₁ /FVC, %	36		DL _{CO} , ml/min per mm Hg	16.5	51
MVV, L/min	38				

Cardiopulmonary Exercise Test					
Protocol: Maximal, symptom limited, incremental cycle ergometry, 10 W/min					
P _B , 656 mm Hg, P _{lO₂} , 128 mm Hg					
Variable	Peak	% Pred	Variable	Rest	Peak
Work rate, W	70	65	Sa _{O₂} , %	92	83
$\dot{V}O_2$, L/min	1.06	66	Sp _{O₂} , %	90	85
$\dot{V}O_2$, ml/kg per min	17.4	66	Pa _{O₂} , mm Hg	65	55
AT, L/min	0.75	N (> 0.64)	Pa _{CO₂} , mm Hg	38	46
$\Delta\dot{V}O_2/\Delta WR$, ml/min/W	9.3	N (> 8.6)	pH	7.413	7.279
HR, beats/min	141	84	HCO ₃ ⁻ , mEq/L	24	21
O ₂ pulse, ml/beat	7.5	79	P(A-a)O ₂ , mm Hg	20	27
BP, mm Hg	166/72		V _D /V _T	0.45	0.42
\dot{V}_E , L/min	46	121	Lactate, mEq/L	1.4	6.9
f _R , breaths/min	36	N			
$\dot{V}_E/\dot{V}CO_2$, at AT	44	H			
RER	1.03				

Stop: Dyspnea, 10/10

Definition of abbreviations: See Table 19 and GLOSSARY.

ventilation, pulmonary hypertension, increased mechanoreceptor impulses, and increased central drive. The V_T response was amputated, with \dot{V}_E maintained primarily by increases in f_R (Figure 12E). There was no arterial desaturation (Sa_{O₂}) (Figure 12G). Pa_{O₂} increased with exercise due to alveolar hypoventilation (decreased Pa_{CO₂}) (Figure 12H) and the P(A-a)O₂ increased appropriately and was well within normal limits (Figure 12G). Note, however, that pulse oximetry indicated substantial exercise desaturation. Pulse oximetry can be unreliable in patients with poor perfusion of the extremities. V_D/V_T responses trended downward but remained abnormally high at peak exercise (Figure 12H). The metabolic acidosis achieved is reflected in the increase in arterial lactate (Δ 7.2 mEq/L) and the reciprocal decrease in serum bicarbonate (Δ 7 mEq/L).

Conclusion. Abnormal exercise test. Moderate reduction in aerobic capacity. Abnormal response pattern consistent with cardiovascular disease and a predominantly O₂ delivery limitation to exercise. Abnormal ventilatory responses including breathing strategy of decreased V_T and increased f_R, inefficient ventilation ($\dot{V}_E/\dot{V}CO_2$), and abnormal V_D/V_T responses do not appear to have been exercise limiting, consistent with the heart failure literature. The abnormal $\dot{V}_E/\dot{V}CO_2$ and V_D/V_T responses reflect reduced cardiac output and resultant \dot{V}_A/\dot{Q} derangement. This abnormality, in addition to a probable alveolar capillary loss, may be responsible for the reduced DL_{CO}. The normal Sa_{O₂}, Pa_{O₂}, and P(A-a)O₂ responses and, in turn, the abnormal V_D/V_T and $\dot{V}_E/\dot{V}CO_2$ responses are consistent with cardiovascular disease. Deconditioning and skeletal muscle dysfunction as concomitant conditions contributing to exercise intolerance cannot be excluded.

Comments. A $\dot{V}O_{2peak}$ of 60% predicted on a cycle ergometer (approximately 63–67% on a treadmill) is well above the 50% level of $\dot{V}O_{2max}$ associated with poor survival of patients with chronic heart failure (44). Consequently, emergent cardiac trans-

plantation was not indicated at this time and she was maintained on her optimized medical regimen. This thin female demonstrates the value of expressing $\dot{V}O_2$ (liters per minute) as the absolute magnitude and as percent predicted rather than just in milliliters per kilogram per minute. In addition, the patient's CPET results provided the basis for an individualized cardiac rehabilitation prescription and an objective measure of interval evaluation.

Case provided by Idelle M. Weisman, M.D.

Case study 3: maximal CPET in a patient with COPD.

Clinical history. A 66-year-old white male with severe COPD maintained on ipratropium bromide, budesonide, salmeterol, and (as needed) albuterol metered dose inhalers, was referred for CPET because of increasing dyspnea on exertion over the last year. He was also taking lisinopril for well-controlled hypertension and cimetidine (Tagamet) for gastroesophageal reflux disease. The patient had a smoking history of more than 50 pack-years but had stopped 12 years earlier, when the diagnosis of COPD was first established. He has a chronic intermittently productive cough. He has lost 16 kg over the last 5 years. A chest radiograph showed hyperinflation. Routine screening laboratory tests were within normal limits. Resting ECG showed nonspecific ST-T changes and was without change from an ECG done 1 year earlier. There had been no change in PFTs over the last 1 year. Anthropomorphic data, PFTs, and peak exercise results appear in Table 21 with graphic data appearing in Figure 13. A CPET with arterial line was performed to determine the magnitude of ABG changes during exercise and for the determination of pulmonary gas exchange as DL_{CO} was 51% of predicted.

Interpretation. PFTs: Severe obstructive ventilatory impairment with borderline improvement in flows and volumes (12%) after inhaled bronchodilator treatment (not shown). Lung volumes confirmed air trapping. A moderate to severe reduction in DL_{CO} is observed.

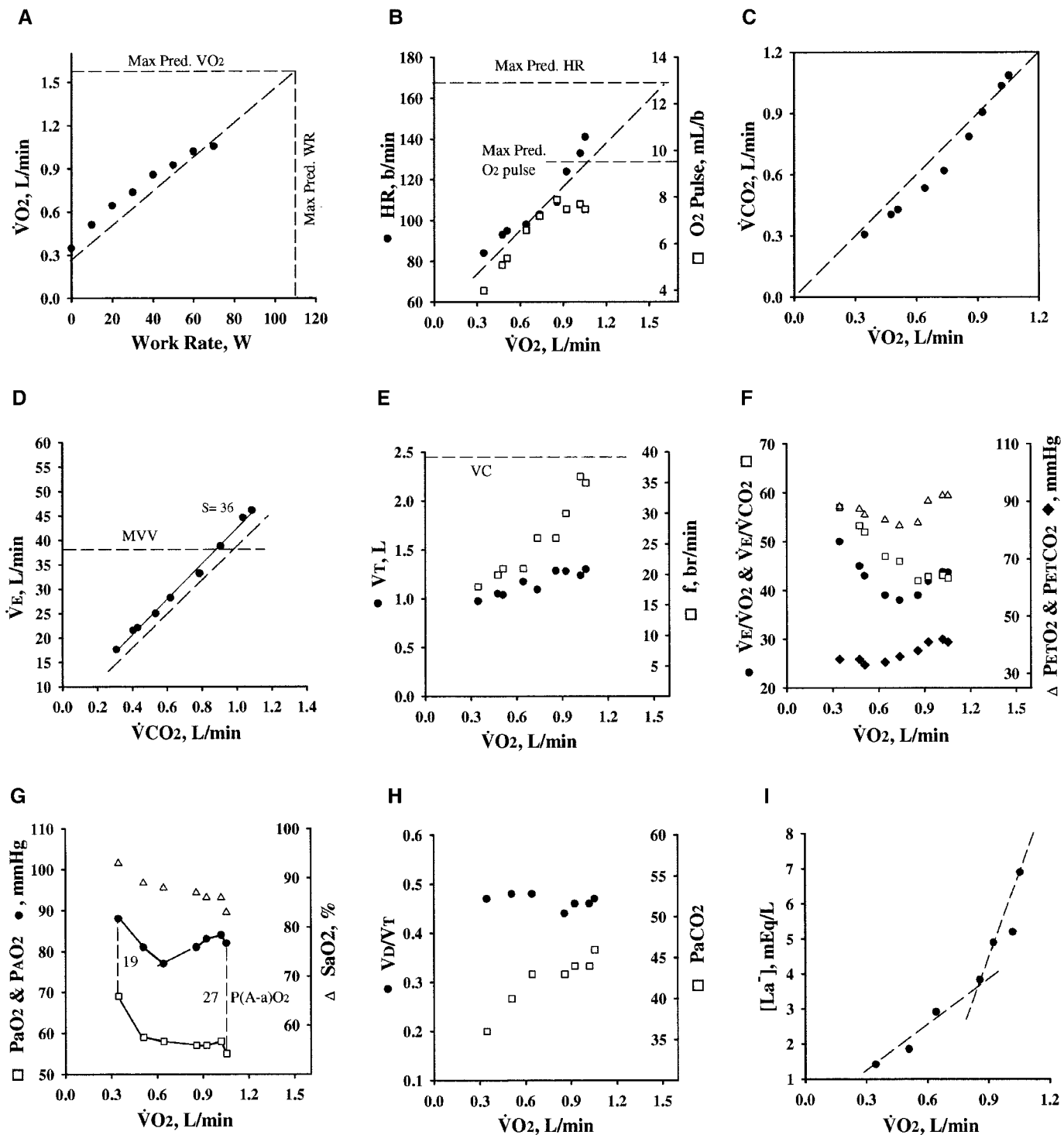

Figure 13. Graphic representation of the maximal, incremental, cardiopulmonary exercise response of a patient with COPD. These graphic data are averaged over an interval of 1 minute. The results (symbols) are compared with calculated reference values obtained from several sources (dashed lines). (A) Oxygen uptake ($\dot{V}O_2$) versus work rate; (B) heart rate (HR) and O₂ pulse versus $\dot{V}O_2$; (C) indirect determination of the anaerobic threshold (AT), using the modified V-slope method, in which carbon dioxide production ($\dot{V}CO_2$) is plotted versus $\dot{V}O_2$; (D) minute ventilation ($\dot{V}E$) versus carbon dioxide output ($\dot{V}CO_2$); (E) tidal volume (V_T) and respiratory frequency (f_R) versus $\dot{V}O_2$; (F) ventilatory equivalent for O₂ ($\dot{V}E/\dot{V}O_2$), ventilatory equivalent for CO₂ ($\dot{V}E/\dot{V}CO_2$), end-tidal pressure for O₂ (P_{ET,O_2}), and end-tidal pressure for CO₂ (P_{ET,CO_2}) versus $\dot{V}O_2$. Graph F is also used for the determination of the AT, using the ventilatory equivalents method. (G) Alveolar O₂ pressure (P_{A,O_2}), arterial O₂ tension (P_{a,O_2}), alveolar-arterial O₂ pressure difference [$P(A-a)O_2$], and arterial O₂ saturation (Sa_{O_2}) versus $\dot{V}O_2$; (H) physiologic dead space-to-tidal volume ratio (V_D/V_T) and arterial CO₂ tension (P_{a,CO_2}) versus $\dot{V}O_2$; (I) determination of the AT, using the plot of arterial lactate versus $\dot{V}O_2$. (Case courtesy of Idelle M. Weisman, M.D.)

Interpretation of exercise: Excellent effort was evidenced by patient achieving physiologic (ventilatory limitation) and by clinically appearing truly exhausted; exercise stopped due to dyspnea (10/10). Moderate reduction in aerobic capacity was noted (Figure 13A). There was a moderate reduction in peak work rate, with a normal slope of the $\dot{V}O_2$ -WR relationship (Figure 13A). The slope of the HR- $\dot{V}O_2$ relationship appears normal with a suggestion of a leftward shift (increased HR at submaximal $\dot{V}O_2$) as has been reported in COPD. A low peak HR and significant heart rate reserve at peak exercise (about 27 beats) were observed (Figures 13B and 13I); the peak O_2 pulse is reduced (Figure 13B). There were normal exercise BP responses and nonspecific ST-T changes on ECG. The AT is at the lower limits of normal (Figure 13C). This pattern of cardiovascular and AT responses may be seen in patients with COPD who are ventilatory limited and also deconditioned.

Abnormal respiratory responses including both mechanical ventilatory and pulmonary gas exchange were observed. $\dot{V}E_{peak}$ was reduced, but when referenced to MVV, peak $\dot{V}E/MVV = 121\%$, indicating no ventilatory reserve (Figure 13D), defining ventilatory limitation to exercise. Breathing strategy reflected that the increase in V_T was limited (most probably due to dynamic hyperinflation), with increases in $\dot{V}E$ achieved mostly through increases in f_R (Figure 13E). Other abnormal ventilatory responses included excessive ventilation for the metabolic requirement throughout exercise as manifested by an abnormal slope of the $\dot{V}E$ -versus- $\dot{V}CO_2$ relationship (slope, 44), an abnormal $\dot{V}E$ -versus- $\dot{V}O_2$ relationship (not shown), and increased values for $\dot{V}E/\dot{V}CO_2$ and $\dot{V}E/\dot{V}O_2$ throughout exercise (Figure 13F).

Pulmonary gas exchange abnormalities included impressive arterial desaturation (decreased by 9%) (Figure 13G), hypoxemia with a decrease in Pa_{O_2} ($\Delta 10$ mm Hg) (Figure 13G), essentially unchanged V_D/V_T ($0.45 \rightarrow 0.42$) (Figure 13H), and an increase in Pa_{CO_2} (increased by 8 mm Hg) (Figure 13H). The latter reflects lung hyperinflation and marked \dot{V}_A/\dot{Q} abnormalities with blunted tidal volume expansion due to lung hyperinflation and, consequently, a reduced level of alveolar ventilation due to increased dead space ventilation. It also reflects possibly blunted ventilatory responses to metabolic acidosis and perhaps respiratory muscle fatigue, which could be exacerbated under hypoxic muscle conditions. The drop in Pa_{O_2} was mostly due to alveolar hypoventilation and \dot{V}_A/\dot{Q} mismatching as reflected by the increase in Pa_{CO_2} and a lesser magnitude increase in $P(A-a)O_2$ at peak exercise (to only 27 mm Hg) than would otherwise be anticipated. The acid-base status at peak exercise is most consistent with combined respiratory (due to alveolar hypoventilation) and metabolic (due to lactic acidosis) acidosis.

Conclusion. Abnormal exercise test, moderate reduction in aerobic capacity consistent with reduced level of fitness. Abnormal respiratory factors due to COPD were exercise limiting. Ventilatory limitation due to mechanical derangement was associated with a spectrum of pulmonary gas exchange abnormalities including inefficient ventilation (increased $\dot{V}E/\dot{V}CO_2$), due to increased dead space ventilation (V_D/V_T), arterial desaturation (decreased Sa_{O_2}), hypoxemia (decreased Pa_{O_2}), and possible blunted ventilatory response to metabolic acidosis (increased Pa_{CO_2}). These factors contributed to this patient's ventilatory demand exceeding capacity and consequent ventilatory limitation and overall exercise intolerance. The low peak HR and low O_2 pulse are consistent with ventilatory limitation to exercise. The O_2 pulse could have been reduced because of early termination of exercise (ventilatory limitation), hypoxemia, deconditioning and/or skeletal muscle dysfunction, and, theoretically, also because of the hemodynamic consequences of dynamic hyperinflation.

Comment. Invasive CPET was helpful in providing valuable information to determine magnitude of Pa_{O_2} drop and acid-base

status, and to establish the need for and titration of supplemental O_2 during exercise that was used for writing an individualized exercise prescription for pulmonary rehabilitation.

Case contributed by Idelle M. Weisman, M.D.

Case study 4: maximal CPET in a patient with interstitial pulmonary fibrosis.

Clinical history. A 72-year-old white male with recent biopsy-diagnosed interstitial pulmonary fibrosis was referred for CPET with arterial line as baseline evaluation for exercise intolerance and desaturation before initiation of systemic corticosteroids. He had been experiencing progressive dyspnea on exertion over the preceding year. He was a lifelong nonsmoker with an unremarkable past medical history, and was not taking any medications. His resting ECG was within normal limits. A chest roentgenogram and high-resolution computed tomography scan of the chest were consistent with IPF.

Anthropomorphic data, PFTs, and peak exercise results appear in Table 22 with graphic data appearing in Figure 14.

Interpretation. PFTs demonstrated mild to moderate restrictive ventilatory impairment confirmed by lung volume determination, which demonstrated proportional reduction of all compartments including TLC and RV. Severe reduction in DL_{CO} was noted.

Exercise. Excellent effort evidenced by patient approaching physiologic (ventilatory) limitation and by obvious patient exhaustion; exercise stopped due to dyspnea (6/10) and leg fatigue (5/10). Moderate reductions in peak aerobic capacity ($\dot{V}O_2$) and peak work rate were noted (Figure 14A). The $\dot{V}O_2$ -WR relationship was normal (Figure 14A). The O_2 pulse was mildly reduced without an apparent plateau effect (Figure 14B). The HR- $\dot{V}O_2$ relationship was left shifted (increased HR at submaximal $\dot{V}O_2$) but with a normal slope; peak heart rate was low (81% of predicted) with significant heart rate reserve (31 beats). ECG and BP responses were WNL. The AT was borderline low-normal (Figures 14C, 14F, and 14I). This pattern of cardiovascular abnormalities and AT responses may be seen in patients (with IPF) who are ventilatory limited and deconditioned.

An impressive pattern of respiratory abnormalities was noted. $\dot{V}E_{peak}$ was reduced and, when referenced to MVV, peak $\dot{V}E/MVV$ approached the ventilatory ceiling (peak $\dot{V}E/MVV = 93\%$ of predicted; 95% CI $\approx 85\%$) with only 4 L of ventilatory reserve remaining, helping to define physiologic (ventilatory) limitation (Figure 14D). Other abnormal ventilatory responses included excessive ventilation for the metabolic requirement throughout exercise as manifested by an abnormal slope of the $\dot{V}E$ -versus- $\dot{V}CO_2$ relationship (slope, 38) (Figure 14D), an abnormal $\dot{V}E$ -versus- $\dot{V}O_2$ relationship (not shown), and increased values for $\dot{V}E/\dot{V}CO_2$ and $\dot{V}E/\dot{V}O_2$ throughout exercise (Figure 14F). The increase in $\dot{V}E$ was accomplished by increases in f_R as the increase in V_T was most probably reduced by mechanical derangement (Figure 14E). The abnormal ventilatory responses were likely due to several factors: abnormal mechanics of breathing, increased mechanoreceptor stimulation, inefficient ventilation, increased dead space ventilation, and hypoxemia.

Pulmonary gas exchange abnormalities, including inefficiency of ventilation, evidenced as abnormal $\dot{V}E/\dot{V}CO_2$ at AT and throughout exercise, were observed (Figure 14F). The increase in $\dot{V}E/\dot{V}CO_2$ was most probably due to increased dead space ventilation due to \dot{V}/\dot{Q} mismatching. Increased dead space ventilation was confirmed by clearly abnormal V_D/V_T responses, which did not show the usual fall with exercise (Figure 14H). Despite excessive ventilation and the presence of significant metabolic acidosis, the Pa_{CO_2} response was also essentially unchanged during exercise, reflecting inefficient ventilation and increased dead space ventilation (Figure 14H). Noteworthy arterial desaturation ($94\% \rightarrow 80\%$) and hypoxemia ($72 \rightarrow 49$ mm

TABLE 22. RESULTS OF MAXIMAL CARDIOPULMONARY EXERCISE TESTING FOR A PATIENT WITH INTERSTITIAL LUNG DISEASE

72 year-old male; white; height, 170 cm; weight, 80 kg; ideal weight, 74 kg
 Clinical Dx: Idiopathic pulmonary fibrosis
 Medications: None
 Reason for testing: IPF: assessment of exercise tolerance, evaluate desaturation

Resting Pulmonary Function Tests					
Variable	Actual	% Pred	Variable	Actual	% Pred
FVC, L	2.34	60	TLC, L	3.78	66
FEV ₁ , L	1.70	65	RV, L	1.60	67
FEV ₁ /FVC, %	72		DL _{CO} , ml/min per mm Hg	12.2	43
MVV, L/min	61				

Cardiopulmonary Exercise Test					
Protocol: Maximal, symptom limited, incremental cycle ergometry, 15 W/min					
P _B , 722 mm Hg; P _{iO₂} , 142 mm Hg					
Variable	Peak	% Pred	Variable	Rest	Peak
Work rate, W	95	64	Sa _{O₂} , %	94	80
\dot{V}_{O_2} , L/min	1.19	67	Pa _{O₂} , mm Hg	72	49
\dot{V}_{O_2} , ml/kg per min	14.9	62	Pa _{CO₂} , mm Hg	42	42
AT _r , L/min	0.80	(> 0.70)	pH	7.39	7.31
HR, beats/min	132	81	P(A-a)O ₂ , mm Hg	24	47
O ₂ pulse, ml/beat	9.0	83	V _D /V _T	0.40	0.40
BP, mm Hg	172/86				
\dot{V}_E , L/min	57	93			
f _R , breaths/min	42	N			
\dot{V}_E/\dot{V}_{CO_2} , at AT	49	H			
RER	1.04				

Stop: Dyspnea, 6/10; leg fatigue, 5/10

Definition of abbreviations: See Table 19.

Hg) associated with an abnormally widened P(A-a)O₂ (24 → 47 mm Hg) were also observed (Figure 14G). In addition to contributing to the excessive ventilation noted earlier, the significant hypoxemia may also have contributed to reduced O₂ delivery via hypoxic pulmonary vasoconstriction and reduced O₂ content.

Conclusion. Abnormal exercise test. Moderate reduction in aerobic capacity consistent with a low level of fitness. Exercise limitation in this patient was multifactorial with ventilatory limitation to exercise the apparent major contributor as was Hypoxemia. Other factors including deconditioning and skeletal muscle dysfunction most probably also contributed to exercise intolerance in this patient (see Section VIII.4.5: ILD).

Comment. Cardiovascular limitation recently reported in some patients with IPF was not apparent at this time in this patient. Interval CPET would be helpful in evaluating any subsequent development of cardiovascular limitation.

Case contributed by Darcy Marciniuk, M.D.

Case study 5: maximal CPET in a patient with pulmonary vascular disease.

Clinical history. A 22-year-old black man, status post empyema and decortication, with documented proximal deep venous thrombosis and recurrent pulmonary emboli in the preceding year, was referred for CPET because of persistent dyspnea on exertion disproportionate to PFTs. The only medication was warfarin (Coumadin). Anthropomorphic data, PFTs, and peak exercise results appear in Table 23 with graphic data appearing in Figure 15.

Interpretation. PFTs: Mild restrictive ventilatory impairment with mild reduction in DL_{CO} (predicted values are race corrected).

Exercise. Because of the clinical history and likelihood of pulmonary gas exchange abnormalities, a CPET with indwelling arterial line was performed. Maximal effort was evidenced by patient being diaphoretic and obviously exhausted, peak RER = 1.26, and HR_{peak} = 90% predicted; exercise was stopped due

to dyspnea (10/10). Aerobic capacity and peak WR were moderately reduced, with a normal slope of the \dot{V}_{O_2} -WR relationship and a suggestion of possible (early) plateauing (Figure 15A). The O₂ pulse is moderately reduced with evidence of an early plateau (Figure 15B). Combined cardiovascular and ventilatory physiologic limitation was approached/achieved with peak HR = 90% predicted but with 20 beats of heart rate reserve and borderline peak \dot{V}_E/MVV = 80% and accompanied by profound tachypnea (f_R = 66). The HR- \dot{V}_{O_2} relationship was left shifted (increased HR at submaximal \dot{V}_{O_2}) with an abnormal slope (Figure 15B). Early onset metabolic acidosis (AT = 27% \dot{V}_{O_2} , peak predicted) is demonstrated (Figures 15C, 15F, and 15I). There were no BP or ECG abnormalities. The pattern of cardiovascular abnormalities and the early onset of metabolic acidosis in this clinical setting are consistent with O₂ delivery limitation as a major contributing factor to this patient's exercise intolerance.

Ventilatory reserve at peak exercise (peak \dot{V}_E/MVV = 80%, 95% CI ≈ 85%) was borderline abnormal (Figure 15D). Consequently, for interpretative purposes, other ventilatory responses, which provide insight into breathing strategy, are considered (see below, f_R response and flow limitation). Abnormal exaggerated ventilatory responses, including excessive ventilation for the metabolic requirement throughout exercise as manifested by an abnormal slope of the \dot{V}_E -versus- \dot{V}_{CO_2} relationship (slope, 51) (Figure 15D), an abnormal \dot{V}_E -versus- \dot{V}_{O_2} relationship (not shown), and increased values for \dot{V}_E/\dot{V}_{CO_2} and \dot{V}_E/\dot{V}_{O_2} (Figure 15F), were observed. The breathing pattern was abnormal with a blunted increase in V_T and with \dot{V}_E increasing mostly due to increases in f_R, achieving 66 breaths per minute at peak exercise (Figure 15E). At this level of respiratory frequency, the patient was most likely flow limited. The abnormal ventilatory responses are most probably due to several factors: increased proprioceptor stimulus to breathing, early onset metabolic acidosis, pulmonary hypertension, and a spectrum of pulmonary gas exchange

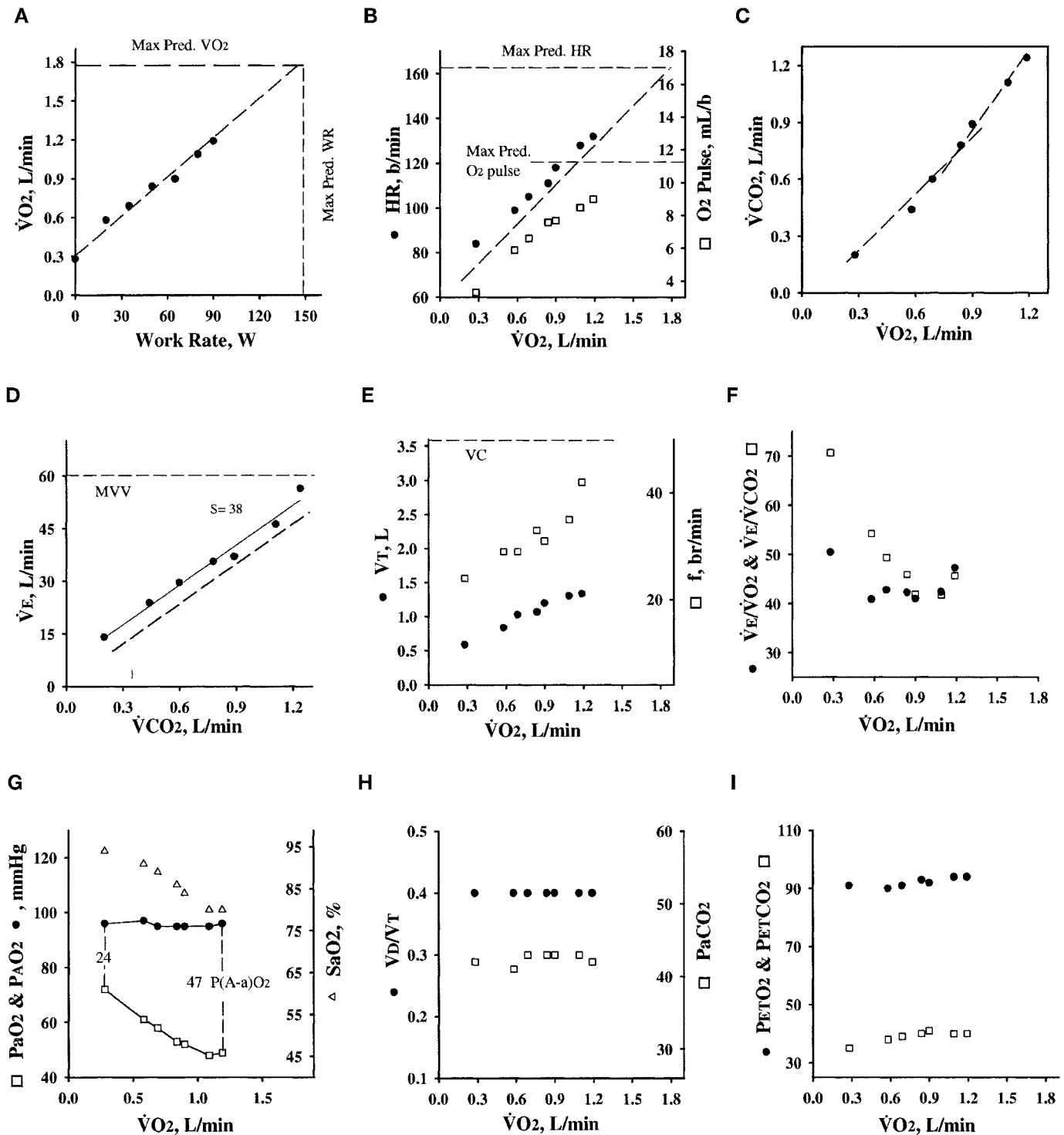

Figure 14. Graphic representation of the maximal, incremental, cardiopulmonary exercise response of a patient with interstitial lung disease. These graphic data are averaged over an interval of 1 minute. The results (symbols) are compared with calculated reference values obtained from several sources (dashed lines). (A) Oxygen uptake ($\dot{V}O_2$) versus work rate; (B) heart rate (HR) and O_2 pulse versus $\dot{V}O_2$; (C) indirect determination of the anaerobic threshold (AT), using the modified V-slope method, in which carbon dioxide production ($\dot{V}CO_2$) is plotted versus $\dot{V}O_2$; (D) minute ventilation (\dot{V}_E) versus carbon dioxide output ($\dot{V}CO_2$); (E) tidal volume (V_T) and respiratory frequency (f_R) versus $\dot{V}O_2$; (F) ventilatory equivalent for O_2 ($\dot{V}_E/\dot{V}O_2$), ventilatory equivalent for CO_2 ($\dot{V}_E/\dot{V}CO_2$) versus $\dot{V}O_2$. Graph F is also used for the determination of the AT, using the ventilatory equivalents method. (G) Alveolar O_2 pressure (P_{AO_2}), arterial O_2 tension (P_{aO_2}), alveolar-arterial O_2 pressure difference [$P(A-a)O_2$], and arterial O_2 saturation (SaO_2) versus $\dot{V}O_2$; (H) physiologic dead space-to-tidal volume ratio (V_D/V_T) and arterial CO_2 tension (P_{aCO_2}) versus $\dot{V}O_2$. (I) End-tidal pressure for O_2 (P_{ETO_2}), and end-tidal pressure for CO_2 (P_{ETCO_2}) versus $\dot{V}O_2$. (Case courtesy of Darcy Marciniuk, M.D.)

TABLE 23. RESULTS OF MAXIMAL CARDIOPULMONARY EXERCISE TESTING FOR A PATIENT WITH PULMONARY VASCULAR DISEASE

22-year-old male; black; height, 185 cm; weight, 77 kg; ideal weight, 85 kg
 Clinical Dx: status post empyema and decortication, deep venous thrombosis, pulmonary embolism
 Medications: Warfarin
 Reason for testing: Dyspnea on exertion disproportionate to PFTs

Resting Pulmonary Function Tests					
Variable	Actual	% Pred	Variable	Actual	% Pred
FVC, L	3.65	72	TLC, L	5.06	78
FEV ₁ , L	3.41	81	RV, L	1.41	103
FEV ₁ /FVC, %	93		DL _{CO} , mL/min per mm Hg	30.9	74
MVV, L/min	156				

Cardiopulmonary Exercise Test					
Protocol: Maximal, symptom limited, incremental cycle ergometry, 15 W/min					
P _B , 656 mm Hg; P _{iO₂} , 128 mm Hg					
Variable	Peak	% Pred	Variable	Rest	Peak
Work rate, W	150	56	Sa _{O₂} , %	91	87
\dot{V} O ₂ , L/min	1.96	60	Pa _{O₂} , mm Hg	67	58
\dot{V} O ₂ , ml/kg per min	25.6	60	P _{aCO₂} , mm Hg	36	29
AT, L/min	1.05	L (> 1.31)	pH	7.393	7.394
$\Delta\dot{V}$ O ₂ / Δ WR, ml/min/W	9.2	N (> 8.6)	HCO ₃ ⁻ , mEq/L	22	17
HR, beats/min	176	90	P(A-a)O ₂ , mm Hg	19	42
O ₂ pulse, ml/beat	11.1	66	V _D /V _T	0.32	0.35
BP, mm Hg	174/86				
\dot{V} E, L/min	125	80			
fr, breaths/min	66	H			
\dot{V} E/ \dot{V} CO ₂ , at AT	41	H			
RER	1.26				

Stop: Dyspnea, 10/10

Definition of abbreviations: See Table 19 and GLOSSARY.

abnormalities including hypoxemia, inefficient ventilation, and increased dead space ventilation.

Impressive pulmonary gas exchange abnormalities, including inefficiency of ventilation reflected in abnormal \dot{V} E/ \dot{V} CO₂ at the AT and throughout exercise, were observed (Figure 15F). The increase in \dot{V} E/ \dot{V} CO₂ was most probably due to increased dead space ventilation due to \dot{V} / \dot{Q} mismatching consequent to reduced pulmonary perfusion. Increased dead space ventilation evidenced by abnormal increases in V_D/V_T (0.32 → 0.35) was noted (Figure 15H). There was significant arterial desaturation (decreased by 4%), a reduced Pa_{O₂} (67 → 58 mm Hg), and an associated abnormally widened P(A-a)O₂ (19 → 42 mm Hg) (Figure 15G). Acid-base status suggests a possible mixed metabolic acidosis and respiratory alkalosis, the latter reflecting increased excessive nonchemical stimuli and hypoxemia.

Conclusion. Cardiovascular (pulmonary circulatory) and borderline ventilatory limitation to exercise with significant pulmonary gas exchange abnormalities consistent with the spectrum of response that can be seen in patients with pulmonary vascular disease.

Comments. This case demonstrates the spectrum of exercise cardiovascular and respiratory abnormalities that can be observed in patients with more advanced pulmonary vascular disease. PFTs including DL_{CO} were able to predict neither the extent of pulmonary gas exchange abnormality nor the level of functional performance. Ultimately, it is the heart's inability to maintain adequate cardiac output that determines most of the exercise limitation in patients with pulmonary vascular disease. Finally, this case demonstrates the difficulty in interpreting CPET results when variable responses are borderline in defining cardiovascular limitation and borderline in defining ventilatory limitation. For example, peak HR = 90% predicted but with 20 beats of

heart rate reserve, while a borderline peak \dot{V} E/MVV = 80% but with likely flow limitation because fr = 66.

A pulmonary angiogram demonstrated significant persistent bilateral pulmonary vascular abnormalities. Hemodynamic studies revealed a resting mean pulmonary artery pressure of 38 mm Hg (systolic/diastolic, 70/45 mm Hg) and a mean pulmonary artery occlusion pressure of 8 mm Hg. A pulmonary thromboendarterectomy was performed.

Case adapted from Weisman and Zeballos (1).

IX. RECOMMENDATIONS FOR FUTURE STUDIES

1. Reference values: It is essential that a multicenter study be undertaken, in which certified laboratories functioning in a coordinated fashion provide normal reference values in compliance with the requirements specified in this statement. This is based on the realization that satisfying the requirements for an optimal set of normal reference values represents a task not likely to be accomplished by a single research center
2. Interpretation: To successfully implement an evidence-based approach for CPET interpretation, the following database, using standardized methodology, protocols, and reporting of patient effort and symptoms, is necessary:
 - Sensitivity, specificity, and positive predictive values and limitations of individual variable responses in diagnosing and distinguishing different clinical entities
 - Sensitivity, specificity, and positive predictive values of patterns of response in diagnosing and distinguishing different clinical entities
 - Criteria to establish classification for designating severity of abnormality (mild, moderate, and severe individual variable responses) and of patterns of response that relate statistical values to clinical status

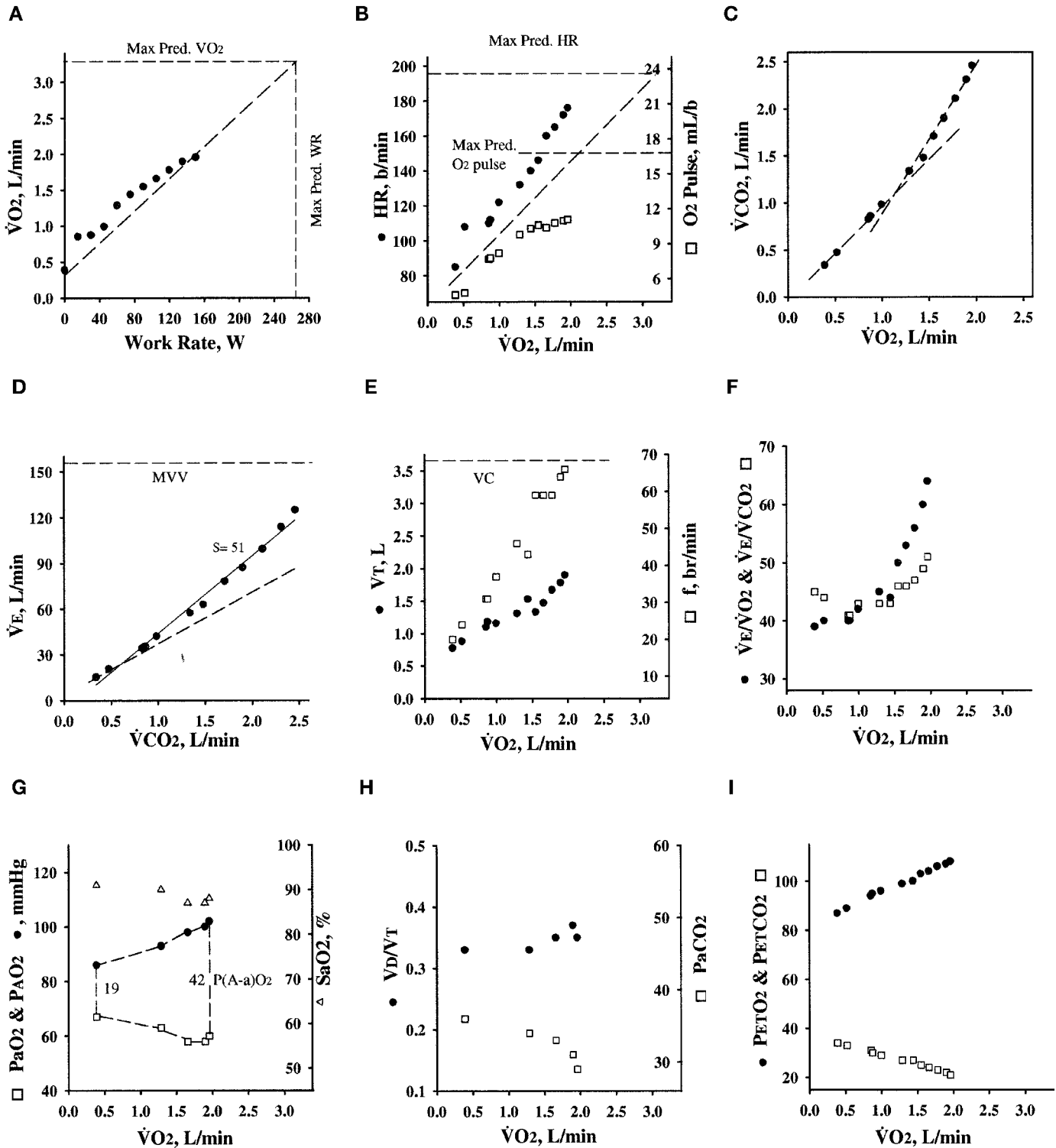

Figure 15. Graphic representation of the maximal, incremental, cardiopulmonary exercise response of a patient with pulmonary vascular disease. These graphic data are averaged over an interval of 1 minute. The results (*symbols*) are compared with calculated reference values obtained from several sources (*dashed lines*). (A) Oxygen uptake ($\dot{V}O_2$) versus work rate; (B) heart rate (HR) and O₂ pulse versus $\dot{V}O_2$; (C) indirect determination of the anaerobic threshold (AT), using the modified V-slope method, in which carbon dioxide production ($\dot{V}CO_2$) is plotted versus $\dot{V}O_2$; (D) minute ventilation (\dot{V}_E) versus carbon dioxide output ($\dot{V}CO_2$); (E) tidal volume (V_T) and respiratory frequency (f_R) versus $\dot{V}O_2$; (F) ventilatory equivalent for O₂ ($\dot{V}_E/\dot{V}O_2$), ventilatory equivalent for CO₂ ($\dot{V}_E/\dot{V}CO_2$) versus $\dot{V}O_2$. Graph F is also used for the determination of the AT, using the ventilatory equivalents method. (G) Alveolar O₂ pressure ($P_{A}O_2$), arterial O₂ tension ($P_{a}O_2$), alveolar-arterial O₂ pressure difference [$P_{(A-a)}O_2$], and arterial O₂ saturation ($S_{a}O_2$) versus $\dot{V}O_2$; (H) physiologic dead space-to-tidal volume ratio (V_D/V_T) and arterial CO₂ tension ($P_{a}CO_2$) versus $\dot{V}O_2$. (I) End-tidal pressure for O₂ ($P_{ET}O_2$), and end-tidal pressure for CO₂ ($P_{ET}CO_2$) versus $\dot{V}O_2$. Modified by permission from Reference 1.

- Criteria for classification of functional class (level of fitness) based on CPET results ($\dot{V}O_2$ peak)
 - Determination of impact of a pattern-based approach to CPET interpretation on clinical decision making and outcomes
 - Clinical value of emerging technology, for example, value of exercise tidal flow–volume loops and/or negative expiratory pressure in the interpretation of CPET results
 - Relationships between perceptual and physiologic responses during exercise
3. Methodology: Decision analysis for invasive versus noninvasive CPET—advantages and limitations
 4. Protocols: Development and validation of new exercise protocols for specific indications; role of constant work protocols in clinical evaluation
 5. Equipment: Quality assurance validation issues for industry; validation of laboratory calibration recommendations

X. GLOSSARY

AT (anaerobic threshold): Exercise $\dot{V}O_2$ that marks the transition between no change or little change in arterial lactate concentration and the sustained increase in concentration of lactate (also known as the lactate threshold). Postulated by some authors to be the $\dot{V}O_2$ above which anaerobic energy production substantially supplements aerobic energy production

ATPS (ambient temperature, pressure, saturated with water): Volume of gas at ambient (e.g., room) temperature and pressure, and saturated with water vapor at this temperature

B by B (Breath by breath): Value of a particular physiologic variable measured over one breath (entire respiratory cycle) and extrapolated to 1 minute (e.g., O_2 uptake for a single breath, expressed as liters per minute)

BTPS (body temperature, pressure, saturated with water): Volume of gas at body temperature (37°C), ambient pressure, and saturated with water vapor at the subject's body temperature

Ca_{O_2} (oxygen content in arterial blood): Volume of O_2 (in milliliters) in a given volume of arterial blood (deciliters or liters)

$C\bar{v}O_2$ (oxygen content in mixed venous blood): Volume of O_2 (in milliliters) in a given volume of mixed venous blood (deciliters or liters)

$C(a-\bar{v})O_2$ (arterial–mixed venous difference for oxygen content): Difference in O_2 content between arterial and mixed venous blood; expressed in milliliters of O_2 per deciliter or liter of blood

CW (constant work rate test): Exercise test in which a constant work rate (or power output) is imposed on the subject (*see* SS [Steady state])

EELV (end-expiratory lung volume): Lung volume at the end of an exercise tidal volume. Dynamic FRC resulting from recruitment of expiratory and inspiratory muscles and timing. $EELV = TLC - IC$

FEV_1 (forced expiratory volume in 1 second): Volume of gas exhaled from the lungs during the first second of a forced expiratory maneuver (FVC), expressed in liters (BTPS)

f_R (respiratory frequency): Number of breathing cycles per minute

HR (heart rate): Number of heart beats per minute

HRR (heart rate reserve): Difference between the highest heart rate attained during a maximal exercise test and the maximal value predicted for that subject. Expressed in units of beats per minute

IET (incremental exercise test): Exercise test designed to provide gradational stress to the subject, typically to the limit of tolerance. The work rate is increased progressively in uniform

increments, usually every minute (or 2 or 3 minutes), or continuously (e.g., ramp pattern increment)

LT (lactate threshold): *See* AT (Anaerobic threshold)

MET (metabolic equivalent): Unit used to estimate the metabolic cost of physical activity, in terms of multiples of the subject's resting metabolic rate. One metabolic equivalent is, by convention, 3.5 ml of O_2 uptake per minute per kilogram body weight, and theoretically approximates the resting metabolic rate

Mixing chamber: Device that provides a continuous representation of the mixed expired concentration of the respired gas. This is accomplished by means of a chamber that has a series of baffles so that the dead space and alveolar components of the expirate are completely mixed before the sampling site. It is essential, when using such a device under non-steady-state conditions, to correct for the transport-plus-mixing delay in determining the gas concentration

MVV (maximal voluntary ventilation): Maximal volume of air that can be breathed per minute by a subject. This is conventionally measured from a maximal volitional breathing effort for a short period of time (e.g., 12 seconds) over which the exhaled volume is summed and expressed in units of liters per minute (BTPS)

O_2 debt (oxygen debt): Amount of O_2 utilized, in the recovery phase of exercise, that is in excess of that required to maintain the recovery condition (usually rest or some low recovery work rate) in the steady state. It is expressed in units of milliliters or liters (STPD)

O_2 deficit (oxygen deficit): Difference between the product of steady state O_2 uptake and the work duration and the total O_2 actually taken up by the body during the exercise. It is expressed in units of milliliters or liters (STPD)

O_2 pulse (oxygen pulse): Oxygen uptake divided by the heart rate. Corresponds to the O_2 uptake per heart beat. It is numerically equal to the product of the stroke volume and arterial–mixed venous O_2 difference [$C(a-\bar{v})O_2$] and is expressed in units of milliliters of O_2 per beat. Is used as an estimator of stroke volume when it is assumed that $C(a-\bar{v})O_2$ is maximal and normal. Accordingly, inferences about stroke volume are highly dependent on these assumptions

$P(A-a)O_2$ (alveolar–arterial difference for PO_2): Difference between “ideal” alveolar PO_2 and arterial PO_2 . Expressed in units of millimeters of mercury (or kilopascals)

PET_{CO_2} (end-tidal PCO_2): PCO_2 of respired gas, determined at the end of an exhalation. This is commonly the highest PCO_2 measured during the alveolar phase of the exhalation. It is expressed in units of millimeters of mercury (or kilopascals).

PET_{O_2} (end-tidal PO_2): PO_2 of respired gas, determined at the end of an exhalation. This is typically the lowest PO_2 during the alveolar portion of the exhalation. It is expressed in units of millimeters of mercury (or kilopascals).

(Power): Power is work per unit of time. Consequently, the term is synonymous with “work rate.” It is measured in watts (i.e., joules per second) or kilopond-meters per minute. One watt is equivalent to 6.12 kpm/minute

\dot{Q} (cardiac output): Volume of blood pumped from the heart each minute and expressed in units of liters per minute. It is the product of stroke volume and heart rate

RER or R (respiratory exchange ratio): Ratio of CO_2 output to O_2 uptake per unit of time (measured at the mouth). This ratio reflects not only tissue metabolic exchange of the gases, but also that resulting from transient changes in the body's gas stores. For example, the gas exchange ratio exceeds the respiratory quotient as additional CO_2 is evolved from the body stores during hyperventilation; similarly, the gas ex-

change ratio is less than the respiratory quotient when CO_2 is being retained during hypoventilation

RQ (respiratory quotient): Ratio of the rate of CO_2 production to O_2 consumption. This ratio reflects the metabolic exchange of the gases in the body's tissues and is dictated by substrate utilization

Sa_{O₂} (arterial oxygen saturation): Actual amount of O_2 bound to hemoglobin in a given volume of arterial blood and expressed as a percentage of the total capacity for O_2 binding of the hemoglobin in that blood volume

Sp_{O₂} (arterial oxygen saturation as indicated by pulse oximetry): Noninvasive estimation of arterial hemoglobin oxygen saturation, using a device that utilizes the combined principles of spectrophotometry and pulse plethysmography. The probe (sensor) can be used on the ear lobe or fingertip

SS (steady state): Denotes an exercise situation in which the O_2 uptake equals the O_2 requirements of the tissues. Consequently the O_2 uptake and other cardiopulmonary variables remain fairly constant and there is no accumulation of lactic acid in the body. This condition is usually attained during constant submaximal levels of moderate exercise or under resting conditions. It typically follows a "non-steady-state" phase in which the variable is changing toward its steady state level. The time to achieve a steady state, however, often differs for different physiologic variables

STPD (standard temperature, pressure, dry): Volume of gas under standard conditions of temperature (0°C) and barometric pressure (760 mm Hg), and humidity (partial pressure of water, 0 mm Hg)

\bar{v} (mixed venous blood): Blood from (or in) a vascular compartment representative of the venous blood returning from all the organs of the body. Blood obtained from the pulmonary artery is considered to be mixed venous blood

\dot{V}_A (alveolar ventilation): Conceptually, this is the volume of inspired gas that reaches the alveoli per minute, or the volume of gas that is evolved from the alveoli per minute. In practice, it is computed as the theoretical alveolar ventilation necessary to produce the current level of arterial Pco_2 at the current level of CO_2 output. It is expressed in units of milliliters per minute or liters per minute (BTPS)

VC (vital capacity): Maximal volume of gas exhaled from the point of maximal inspiration, and corresponds to $\text{TLC} - \text{RV}$. It is expressed in units of liters (BTPS)

\dot{V}_{CO_2} (carbon dioxide output): Amount of CO_2 exhaled from the body per unit of time, expressed in milliliters per minute or liters per minute (STPD). This can differ from CO_2 production under conditions in which CO_2 is going to or coming from the body's stores. CO_2 production is the amount of CO_2 produced by the body's metabolic processes, expressed in units of milliliters per minute or liters per minute (STPD). In the steady state, CO_2 output equals CO_2 production

V_D (physiologic dead space): Notional volume of inspired gas that does not reach a gas-exchanging unit. The physiologic dead space is therefore the sum of the anatomic dead space (see below) and the alveolar dead space (the volume of alveoli that are ventilated but unperfused and a component of those that are underperfused). It is expressed in units of milliliters or liters (BTPS)

V_{Dnat} (anatomic dead space): Notional volume of inspired gas that stays in the conducting zone of the airways (that does not reach the alveoli). It is expressed in units of milliliters or liters (BTPS)

V_D/V_T (ratio of physiologic dead space to tidal volume): Proportion of tidal volume that is made up of the physiologic dead space. It is a dimensionless quantity, conventionally expressed

as a fraction. Used as an index of ventilation-perfusion mismatching

\dot{V}_E (minute ventilation): Volume of expired air exhaled from the lungs in 1 minute. This is conventionally expressed in units of liters per minute (BTPS)

\dot{V}_{Emax} (maximal exercise ventilation): Highest minute ventilation achieved during a maximal exercise test. This is usually determined by tests that tax large muscle masses, such as cycle ergometry or treadmill. It is conventionally expressed in liters per minute (BTPS)

\dot{V}_E/MVV (ventilatory reserve): Expresses the relationship of ventilatory demand as reflected by peak \dot{V}_E to ventilatory capacity. MVV is conventionally used as an index of ventilatory capacity. This ratio is expressed as $(\dot{V}_{\text{Emax}}/\text{MVV}) \times 100$. The term is synonymous with *breathing reserve*

$\dot{V}_E/\dot{V}_{\text{CO}_2}$ (ventilatory equivalent for carbon dioxide): Ratio of the subject's minute ventilation (BTPS) to CO_2 output (STPD). It is a dimensionless quantity. This ratio indicates how many liters of air are being breathed to eliminate 1 liter of CO_2 . It is used as a noninvasive estimator of appropriateness of ventilation

$\dot{V}_E/\dot{V}_{\text{O}_2}$ (ventilatory equivalent for oxygen): Ratio of the subject's minute ventilation (BTPS) to O_2 uptake (STPD). It is a dimensionless quantity. This ratio indicates how many liters of air are being breathed for each liter of O_2 uptake

\dot{V}_{O_2} (oxygen uptake): Volume of O_2 extracted from inspired air in a given period of time, expressed in milliliters per minute or liters per minute (STPD). This can differ from O_2 consumption under conditions in which O_2 is flowing into or being utilized from the body's stores. O_2 consumption is the amount of O_2 utilized by the body's metabolic processes in a given time, expressed in units of liters per minute (STPD). In the steady state, O_2 uptake equals O_2 consumption

$\dot{V}_{\text{O}_2\text{max}}$ (maximal oxygen uptake): Traditionally the highest attainable O_2 uptake for a given subject. It is determined during dynamic exercise from a "plateauing" of \dot{V}_{O_2} despite work rate continuing to increase. In the absence of a discernible plateau, the highest \dot{V}_{O_2} actually attained on the test is more properly termed $V_{\text{O}_2\text{peak}}$. Both $\dot{V}_{\text{O}_2\text{max}}$ and $V_{\text{O}_2\text{peak}}$ are conventionally expressed in units of milliliters per minute or liters per minute (STPD) or, corrected for body weight, as milliliters per minute per kilogram

$\dot{V}_{\text{O}_2\text{peak}}$ (oxygen uptake at peak exercise): Highest \dot{V}_{O_2} achieved on a test performed to the limit of tolerance. No additional criteria are needed for its determination, such as evidence of plateauing, to justify a $\dot{V}_{\text{O}_2\text{max}}$. It is conventionally expressed in units of liters per minute or milliliters per minute (STPD)

$\Delta\dot{V}_{\text{O}_2}/\Delta\text{WR}$: Increase in O_2 uptake in response to a simultaneous increase in work rate (see below). Under appropriate conditions, this may be used to estimate the efficiency of muscular work. It is usually expressed in units of milliliters of O_2 per minute (STPD) per watt

V-slope method: One of several noninvasive techniques for estimating the onset of lactic acidosis during an incremental exercise test. It is based on the ability to detect excess CO_2 output generated from bicarbonate buffering of lactic acid

V_T (tidal volume): Volume of air inhaled or exhaled with each breath. Could be the volume of a particular breath or the average breath volume over a specified period of time—usually 1 minute. It is conventionally expressed in units of milliliters or liters (BTPS)

Work: Application of a force through a distance in the direction of the force, or the product of force and the distance over which it is moved. Work is expressed in units of joules (i.e., $\text{kg} \cdot \text{m}^2 \cdot \text{second}^{-2}$). Under conditions in which force is applied and no movement results (e.g., during an isometric contrac-

tion), no work is performed, despite increased metabolic energy expenditure

Work intensity: Unlike the work rate (*see below*), which is an absolute physical construct and measured in units of power, work intensity reflects the relative ease or difficulty of performing a task. The same work rate (e.g., 50 W) could be moderate for one subject but heavy or very heavy for another

WR (work rate or power): Reflects the rate at which work is performed (i.e., work performed per unit of time). Work rate is usually measured in watts (i.e., joules per second) or, alternatively, in kilopond · meters per minute (kpm per minute); 1 W is equivalent to 6.12 kpm/minute

ATS/ACCP STATEMENT ON CARDIOPULMONARY EXERCISE TESTING

This official statement of the American Thoracic Society and the American College of Chest Physicians was prepared by an ad hoc subcommittee of the assembly on clinical problems. The subcommittee was chaired by Idelle M. Weisman, M.D. (ATS Chair). Members of the committee are as follows:

Weisman, Idelle M., Chair, Department of Clinical Investigation and Pulmonary Critical Care Medicine, William Beaumont Army Medical Center, El Paso, Texas

Beck, Kenneth C., Physiological Imaging, Department of Radiology, University of Iowa Medical Center, Iowa City, Iowa

Casaburi, Richard, Division of Respiratory and Critical Care, Physiology, and Medicine, Harbor-UCLA Medical Center, Torrance, California

Cotes, John E., Environmental and Occupational Health, University of Newcastle upon Tyne, Durham, United Kingdom

Crapo, Robert O., Pulmonary Division, LDS Hospital, Salt Lake City, Utah

Dempsey, Jerome A., Department of Preventive Medicine, University of Wisconsin, Madison, Wisconsin

Fairbairn, Mary Sue, Clinical Research, School of Health Sciences, British Columbia Institute of Technology, Burnaby, British Columbia, Canada

Gallagher, Charles G., Respiratory Medicine, St. Vincent's Hospital, Elm Park, Dublin, Ireland

Johnson, Bruce D., Division of Cardiovascular Diseases Research, Mayo Clinic, Rochester, Minnesota

Killian, Kieran, McMaster University Medical Center, Hamilton, Ontario, Canada

Mahler, Donald A., Pulmonary and Critical Care Medicine, Dartmouth-Hitchcock Medical Center, Lebanon, New Hampshire

Marciniuk, Darcy D., Department of Respiratory Medicine, Royal University Hospital, Saskatoon, Saskatchewan, Canada

Martinez, Fernando J., Division of Pulmonary and Critical Care Medicine, University of Michigan, Ann Arbor, Michigan

Myers, Jonathan, Department of Cardiology, Stanford Medical School and Palo Alto Veterans Affairs Healthcare System, Palo Alto, California

Sciurba, Frank C., Division of Pulmonary, Allergy, and Critical Care Medicine, University of Pittsburgh Medical Center, Pittsburgh, Pennsylvania

Sietsema, Kathy E., Respiratory and Critical Care Division, Harbor-UCLA Medical Center, Torrance, California

Swanson, George D., Department of Physical Education, California State University at Chico, Chico, California

Sue, Darryl Y., Division of Respiratory and Critical Care, Department of Medicine, Harbor-UCLA Medical Center, Torrance, California

Wagner, Peter D., Division of Physiology, Department of Medicine, University of California Medical Center at San Diego, La Jolla, California

Whipp, Brian J., Exercise Physiology and Training Center, Harbor-UCLA Medical Center, Torrance, California

Zeballos, R. Jorge, Vice-Chair, William Beaumont Army Medical Center, and Texas Tech Regional Health Science Center, El Paso, Texas

References

1. Weisman IM, Zeballos RJ. An integrated approach to the interpretation of cardiopulmonary exercise testing. *Clin Chest Med* 1994;15:421-445.
2. Sue DY, Wasserman K. Impact of integrative cardiopulmonary exercise testing on clinical decision making. *Chest* 1991;99:981-992.
3. Wasserman K, Hansen JE, Sue DY, Whipp BJ, Casaburi R. Principles of exercise testing and interpretation: including pathophysiology and clinical applications, 3rd ed. Philadelphia: Lippincott Williams & Wilkins; 1999. p. xv.
4. Killian KJ, Leblanc P, Martin DH, Summers E, Jones NL, Campbell EJ. Exercise capacity and ventilatory, circulatory, and symptom limitation in patients with chronic airflow limitation. *Am Rev Respir Dis* 1992;146:935-940.
5. Hamilton AL, Killian KJ, Summers E, Jones NL. Muscle strength, symptom intensity, and exercise capacity in patients with cardiorespiratory disorders. *Am J Respir Crit Care Med* 1995;152:2021-2031.
6. Weisman IM, Zeballos RJ. Cardiopulmonary exercise testing: the need for standardization. *Pulm Perspect* 1992;9:5-8.
7. Fletcher GF, Froelicher VF, Hartley LH, Haskell WL, Pollock ML. Exercise standards: a statement for health professionals from the American Heart Association. *Circulation* 1990;82:2286-2322.
8. Fletcher GF, Blair SN, Blumenthal J, Caspersen C, Chaitman B, Epstein S, Falls H, Froelicher ES, Froelicher VF, Pina IL. Statement on exercise: benefits and recommendations for physical activity programs for all Americans: a statement for health professionals by the Committee on Exercise and Cardiac Rehabilitation of the Council on Clinical Cardiology, American Heart Association. *Circulation* 1992;86:340-344.
9. Perloff D, Grim C, Flack J, Frohlich ED, Hill M, McDonald M, Morgenstern B. Human blood pressure determination by sphygmomanometry. *Circulation* 1993;88:2460-2470.
10. Fletcher GF, Balady G, Froelicher VF, Hartley LH, Haskell WL, Pollock ML, Weisman IM. Exercise standards: a statement for healthcare professionals from the American Heart Association. *Circulation* 1995;91:580-615.
11. Pina IL, Balady GJ, Hanson P, Labovitz AJ, Madonna DW, Myers J. Guidelines for clinical exercise testing laboratories: a statement for healthcare professionals from the Committee on Exercise and Cardiac Rehabilitation, American Heart Association. *Circulation* 1995;91:912-921.
12. Committee on Exercise Testing. ACC/AHA Guidelines for Exercise Testing: a report of the American College of Cardiology/American Heart Association Task Force on Practice Guidelines. *J Am Coll Cardiol* 1997;30:260-311.
13. American Association for Respiratory Care. AARC clinical practice guideline: exercise testing for evaluation of hypoxemia and/or desaturation. *Respir Care* 1992;37:907-912.
14. American College of Sports Medicine. ACSM's guidelines for exercise testing and prescription, 6th ed. Baltimore, MD: Williams & Wilkins; 2000. p. xvi.
15. Mayo Clinic Cardiovascular Working Group on Stress Testing. Cardiovascular stress testing: a description of the various types of stress tests and indications for their use. *Mayo Clin Proc* 1996;71:43-52.
16. American Thoracic Society. Evaluation of impairment/disability secondary to respiratory disorders. *Am Rev Respir Dis* 1986;133:1205-1209.
17. American Thoracic Society. Standardization of spirometry-1987 update: statement of the American Thoracic Society. *Am Rev Respir Dis* 1987;136:1285-1298.
18. American Thoracic Society. Lung function testing: selection of reference values and interpretative strategies. *Am Rev Respir Dis* 1991;144:1202-1218.
19. American Thoracic Society. Standardization of spirometry, 1994: update. *Am J Respir Crit Care Med* 1995;152:1107-1136.
20. American Thoracic Society. Standards for the diagnosis and care of patients with chronic obstructive pulmonary disease. *Am J Respir Crit Care Med* 1995;152:S77-S121.
21. American Thoracic Society. Lung volume reduction surgery: official statement of the American Thoracic Society. *Am J Respir Crit Care Med* 1996;154:1151-1152.
22. American Thoracic Society. Pulmonary rehabilitation: 1999. American Thoracic Society. *Am J Respir Crit Care Med* 1999;159:1666-1682.

23. American Thoracic Society, European Respiratory Society. Skeletal muscle dysfunction in chronic obstructive pulmonary disease: a statement of the American Thoracic Society and European Respiratory Society. *Am J Respir Crit Care Med* 1999;159:S1-S40.
24. American Thoracic Society. Guidelines for methacholine and exercise challenge testing—1999: official statement of the American Thoracic Society. *Am J Respir Crit Care Med* 2000;161:309-329.
25. American Thoracic Society. Pulmonary function laboratory management and procedure manual. New York: American Thoracic Society; 1998.
26. American College of Chest Physicians, American Thoracic Society. Pulmonary terms and symbols: a report of the ACCP-ATS Joint Committee on Pulmonary Nomenclature. *Chest* 1975;67:583-593.
27. Weisman IM, Zeballos RJ. Cardiopulmonary exercise testing. *Pulm Crit Care Update* 1995;11:1-9.
28. Weisman IM, Zeballos RJ. Clinical exercise testing. *Clin Chest Med* 2001;22:679-701.
29. Bye PT, Anderson SD, Woolcock AJ, Young IH, Alison JA. Bicycle endurance performance of patients with interstitial lung disease breathing air and oxygen. *Am Rev Respir Dis* 1982;126:1005-1012.
30. Carlson DJ, Ries AL, Kaplan RM. Prediction of maximum exercise tolerance in patients with COPD. *Chest* 1991;100:307-311.
31. Keogh BA, Lakatos E, Price D, Crystal RG. Importance of the lower respiratory tract in oxygen transfer: exercise testing in patients with interstitial and destructive lung disease. *Am Rev Respir Dis* 1984;129: S76-S80.
32. Sue DY, Oren A, Hansen JE, Wasserman K. Diffusing capacity for carbon monoxide as a predictor of gas exchange during exercise. *N Engl J Med* 1987;316:1301-1306.
33. Ries AL, Farrow JT, Clausen JL. Pulmonary function tests cannot predict exercise-induced hypoxemia in chronic obstructive pulmonary disease. *Chest* 1988;93:454-459.
34. Cotes JE, Zejda J, King B. Lung function impairment as a guide to exercise limitation in work-related lung disorders. *Am Rev Respir Dis* 1988;137:1089-1093.
35. Franciosa JA, Park M, Levine TB. Lack of correlation between exercise capacity and indexes of resting left ventricular performance in heart failure. *Am J Cardiol* 1981;47:33-39.
36. Weber KT, Janicki JS. Cardiopulmonary exercise testing: physiologic principles and clinical applications. Philadelphia: W. B. Saunders; 1986. p. xvi.
37. Szlachcic J, Massie BM, Kramer BL, Topic N, Tubau J. Correlates and prognostic implication of exercise capacity in chronic congestive heart failure. *Am J Cardiol* 1985;55:1037-1042.
38. Punzal PA, Ries AL, Kaplan RM, Prewitt LM. Maximum intensity exercise training in patients with chronic obstructive pulmonary disease. *Chest* 1991;100:618-623.
39. Dillard TA, Piantadosi S, Rajagopal KR. Prediction of ventilation at maximal exercise in chronic air-flow obstruction. *Am Rev Respir Dis* 1985;132:230-235.
40. Dillard TA, Hnatiuk OW, McCumber TR. Maximum voluntary ventilation: spirometric determinants in chronic obstructive pulmonary disease patients and normal subjects. *Am Rev Respir Dis* 1993;147:870-875.
41. Curtis JR, Deyo RA, Hudson LD. Pulmonary rehabilitation in chronic respiratory insufficiency. 7. Health-related quality of life among patients with chronic obstructive pulmonary disease. *Thorax* 1994;49: 162-170.
42. Jones NL. Clinical exercise testing, 3rd ed. Philadelphia: W. B. Saunders; 1988. p. x.
43. Jones NL. Clinical exercise testing, 4th ed. 1997, Philadelphia: W. B. Saunders; p. xi.
44. Stelken AM, Younis LT, Jennison SH, Miller DD, Miller LW, Shaw LJ, Kargl D, Chaitman BR. Prognostic value of cardiopulmonary exercise testing using percent achieved of predicted peak oxygen uptake for patients with ischemic and dilated cardiomyopathy. *J Am Coll Cardiol* 1996;27:345-352.
45. O'Donnell DE. Breathlessness in patients with chronic airflow limitation: mechanisms and management. *Chest* 1994;106:904-912.
46. American Thoracic Society. ATS Statement: Guidelines for the Six-Minute Walk Test. *Am J Respir Crit Care Med* 2002;166:111-117.
47. Pratter MR, Curley FJ, Dubois J, Irwin RS. Cause and evaluation of chronic dyspnea in a pulmonary disease clinic. *Arch Intern Med* 1989;149:2277-2282.
48. Martinez FJ, Stanopoulos I, Acero R, Becker FS, Pickering R, Beamis JF. Graded comprehensive cardiopulmonary exercise testing in the evaluation of dyspnea unexplained by routine evaluation. *Chest* 1994;105:168-174.
49. Weisman IM, Zeballos RJ. Clinical evaluation of unexplained dyspnea. *Cardiologia* 1996;41:621-634.
50. Sridhar MK, Carter R, Banham SW, Moran F. An evaluation of integrated cardiopulmonary exercise testing in a pulmonary function laboratory. *Scott Med J* 1995;40:113-116.
51. Gay SE, Weisman IM, Flaherty KE, Martinez FJ. Cardiopulmonary exercise testing in unexplained dyspnea. In: Weisman IM, Zeballos RJ, editors. Clinical exercise testing. Basel, Switzerland: Karger; 2002. p. 81-88.
52. Hooper RG, Thomas AR, Kearn RA. Mitochondrial enzyme deficiency causing exercise limitation in normal-appearing adults. *Chest* 1995;107: 317-322.
53. Elliot DL, Buist NR, Goldberg L, Kennaway NG, Powell BR, Kuehl KS. Metabolic myopathies: evaluation by graded exercise testing. *Medicine (Baltimore)* 1989;68:163-172.
54. Flaherty KE, Wald J, Weisman IM, Blavais M, Zeballos RJ, Zisman D, Rubenfire M, Martinez FJ. Unexplained exertional limitation: characterization in a large cohort discovered to have mitochondrial myopathy. *Am J Respir Crit Care Med* 2001;164:425-432.
55. Dandurand RJ, Matthews PM, Arnold DL, Eidelman DH. Mitochondrial disease: pulmonary function, exercise performance, and blood lactate levels. *Chest* 1995;108:182-189.
56. Taivassalo T, De Stefano N, Argov Z, Matthews PM, Chen J, Genge A, Karpati G, Arnold DL. Effects of aerobic training in patients with mitochondrial myopathies. *Neurology* 1998;50:1055-1060.
57. Weisman IM, Zeballos RJ. A step approach to the evaluation of unexplained dyspnea: the role of cardiopulmonary exercise testing. *Pulm Perspect* 1998;15:8-11.
58. Zeballos RJ, Weisman IM, Connery SM, Bradley JP. Standard treadmill (STE) vs. incremental cycle ergometry (IET) in the evaluation of airway hyperreactivity in unexplained dyspnea [abstract]. *Am J Respir Crit Care Med* 1999;159:A419.
59. Mancini DM, Eisen H, Kusssmaul W, Mull R, Edmunds LH Jr, Wilson JR. Value of peak exercise oxygen consumption for optimal timing of cardiac transplantation in ambulatory patients with heart failure. *Circulation* 1991;83:778-786.
60. Stevenson LW, Steimle AE, Fonarow G, Kermani M, Kermani D, Hamilton MA, Moriguchi JD, Walden J, Tillisch JH, Drinkwater DC, et al. Improvement in exercise capacity of candidates awaiting heart transplantation. *J Am Coll Cardiol* 1995;25:163-170.
61. Myers J, Gullestad L, Vagelos R, Do D, Bellin D, Ross H, Fowler MB. Clinical, hemodynamic, and cardiopulmonary exercise test determinants of survival in patients referred for evaluation of heart failure. *Ann Intern Med* 1998;129:286-293.
62. Chua TP, Ponikowski P, Harrington D, Anker SD, Webb-Peploe K, Clark AL, Poole-Wilson PA, Coats AJ. Clinical correlates and prognostic significance of the ventilatory response to exercise in chronic heart failure. *J Am Coll Cardiol* 1997;29:1585-1590.
63. Nohria A, Eldrin L, Warner SL. Medical management of advanced heart failure. *JAMA* 2002;287:628-639.
64. Keteyian SJ, Levine AB, Brawner CA, Kataoka T, Rogers FJ, Schairer JR, Stein PD, Levine TB, Goldstein ST. Exercise training in patients with heart failure: a randomized, controlled trial. *Ann Intern Med* 1996;124:1051-1057.
65. Braith RW. Exercise training in patients with CHF and heart transplant recipients. *Med Sci Sports Exerc* 1998;30(10 Suppl):S367-S378.
66. Coats AJ, Adamopoulos S, Radaelli A, McCance A, Meyer TE, Bernardi L, Solda PL, Davey P, Ormerod O, Forfar C. Controlled trial of physical training in chronic heart failure: exercise performance, hemodynamics, ventilation, and autonomic function [see comments]. *Circulation* 1992;85:2119-2131.
67. Hambrecht R, Gielen S, Linke A, Fiehn E, Yu J, Walther C, Schoene N, Schuler G. Effects of exercise training on left ventricular function and peripheral resistance in patients with chronic heart failure: a randomized trial. *JAMA* 2000;283:3095-3101.
68. Braith RW, Edwards DC. Role of cardiac rehabilitation in heart failure and cardiac transplantation. In: Weisman IM, Zeballos RJ, editors. Clinical exercise testing. Basel, Switzerland: Karger; 2002. p. 120-137.
69. Kobashigawa JA, Leaf DA, Lee N, Gleeson MP, Liu H, Hamilton MA, Moriguchi JD, Kawata N, Einhorn K, Herlihy E, et al. A controlled trial of exercise rehabilitation after heart transplantation. *N Engl J Med* 1999;340:272-277.
70. Bittner V, Weiner DH, Yusuf S, Rogers WJ, McIntyre KM, Bangdiwala SI, Kronenberg MW, Kostis JB, Kohn RM, Guillothe M, et al. Prediction of mortality and morbidity with a 6-minute walk test in patients with left ventricular dysfunction. *JAMA* 1993;270:1702-1707.
71. Gallagher CG. Exercise and chronic obstructive pulmonary disease. *Med Clin North Am* 1990;74:619-641.

72. Gallagher CG. Exercise limitation and clinical exercise testing in chronic obstructive pulmonary disease. *Clin Chest Med* 1994;15:305–326.
73. Oelberg DA, Kacmarek RM, Pappagianopoulos PP, Ginns LC, Systrom DM. Ventilatory and cardiovascular responses to inspired He-O₂ during exercise in chronic obstructive pulmonary disease [see comments]. *Am J Respir Crit Care Med* 1998;158:1876–1882.
74. Richardson RS, Sheldon J, Poole DC, Hopkins SR, Ries AL, Wagner PD. Evidence of skeletal muscle metabolic reserve during whole body exercise in patients with chronic obstructive pulmonary disease. *Am J Respir Crit Care Med* 1999;159:881–885.
75. O'Donnell DE, Webb KA. Exertional breathlessness in patients with chronic airflow limitation: the role of lung hyperinflation. *Am Rev Respir Dis* 1993;148:1351–1357.
76. O'Donnell DE, Bertley JC, Chau LK, Webb KA. Qualitative aspects of exertional breathlessness in chronic airflow limitation: pathophysiologic mechanisms. *Am J Respir Crit Care Med* 1997;155:109–115.
77. Carlin BW, Clausen JL, Ries AL. The effects of exercise testing on the prescription of oxygen therapy. *Chest* 1994;106:361–365.
78. Dean NC, Brown JK, Himelman RB, Doherty JJ, Gold WM, Stulberg MS. Oxygen may improve dyspnea and endurance in patients with chronic obstructive pulmonary disease and only mild hypoxemia. *Am Rev Respir Dis* 1992;146:941–945.
79. O'Donnell DE, Magnussen B, Aguilaniu B, Gerken F, Hamilton A, Fluge T. Spiriva (Tiotropium) improves exercise tolerance in COPD. *Am J Respir Crit Care Med* 2002;165:A227.
80. O'Donnell DE, Sani R, Giesbrecht G, Younes M. Effect of continuous positive airway pressure on respiratory sensation in patients with chronic obstructive pulmonary disease during submaximal exercise. *Am Rev Respir Dis* 1988;138:1185–1191.
81. Martinez FJ, de Oca MM, Whyte RI, Stetz J, Gay SE, Celli BR. Lung-volume reduction improves dyspnea, dynamic hyperinflation, and respiratory muscle function. *Am J Respir Crit Care Med* 1997;155:1984–1990.
82. Belman MJ, Botnick WC, Shin JW. Inhaled bronchodilators reduce dynamic hyperinflation during exercise in patients with chronic obstructive pulmonary disease. *Am J Respir Crit Care Med* 1996;153:967–975.
83. O'Donnell DE, Webb KA, Bertley JC, Chau LK, Conlan AA. Mechanisms of relief of exertional breathlessness following unilateral bullectomy and lung volume reduction surgery in emphysema. *Chest* 1996;110:18–27.
84. O'Donnell DE, McGuire M, Samis L, Webb KA. The impact of exercise reconditioning on breathlessness in severe chronic airflow limitation. *Am J Respir Crit Care Med* 1995;152:2005–2013.
85. O'Donnell DE, Lam M, Webb KA. Measurement of symptoms, lung hyperinflation, and endurance during exercise in chronic obstructive pulmonary disease. *Am J Respir Crit Care Med* 1998;158:1557–1565.
86. O'Donnell DE, Lam M, Webb KA. Spirometric correlates of improvement in exercise performance after anticholinergic therapy in chronic obstructive pulmonary disease. *Am J Respir Crit Care Med* 1999;160:542–549.
87. O'Donnell DE, Revill SM, Webb KA. Dynamic hyperinflation and exercise intolerance in chronic obstructive pulmonary disease. *Am J Respir Crit Care Med* 2001;164:770–777.
88. Oga T, Nishimura K, Tsukino M, Hajiro T, Ikeda A, Izumi T. The effects of oxitropium bromide on exercise performance in patients with stable chronic obstructive pulmonary disease. A comparison of three different exercise tests. *Am J Respir Crit Care Med* 2000;161:1897–1901.
89. Maltais F, Simard AA, Simard C, Jobin J, Desgagnés P, LeBlanc P. Oxidative capacity of the skeletal muscle and lactic acid kinetics during exercise in normal subjects and in patients with COPD. *Am J Respir Crit Care Med* 1996;153:288–293.
90. Engelen MP, Schols AM, Does JD, Gosker HR, Deutz NE, Wouters EF. Exercise-induced lactate increase in relation to muscle substrates in patients with chronic obstructive pulmonary disease. *Am J Respir Crit Care Med* 2000;162:1697–1704.
91. Engelen MP, Wouters EF, Deutz NE, Does JD, Schols AM. Effects of exercise on amino acid metabolism in patients with chronic obstructive pulmonary disease. *Am J Respir Crit Care Med* 2001;163:859–864.
92. Fulmer JD, Roberts WC, von Gal ER, Crystal RG. Morphologic-physiologic correlates of the severity of fibrosis and degree of cellular injury in idiopathic pulmonary fibrosis. *J Clin Invest* 1979;63:665–676.
93. Harris-Eze AO, Sridhar G, Clemens RE, Gallagher CG, Marciniuk DD. Oxygen improves maximal exercise performance in interstitial lung disease. *Am J Respir Crit Care Med* 1994;150:1616–1622.
94. Marciniuk DD, Gallagher CG. Clinical exercise testing in interstitial lung disease. *Clin Chest Med* 1994;15:287–303.
95. Risk C, Epler GR, Gaensler EA. Exercise alveolar-arterial oxygen pressure difference in interstitial lung disease. *Chest* 1984;85:69–74.
96. Watters LC, King TE, Schwarz MI, Waldron JA, Stanford RE, Cherniack RM. A clinical, radiographic, and physiologic scoring system for the longitudinal assessment of patients with idiopathic pulmonary fibrosis. *Am Rev Respir Dis* 1986;133:97–103.
97. O'Donnell DE, Laurence KLC, Webb KA. Qualitative aspects of exertional dyspnea in patients with interstitial lung disease. *J Appl Physiol* 1998;84:2000–2009.
98. Krishnan B, Marciniuk DD. Cardiopulmonary responses during exercise in interstitial lung disease. In: Weisman IM, Zeballos RJ, editors. Clinical exercise testing. Basel, Switzerland: Karger; 2002. p. 173–185.
99. Weisman IM, Lynch JP, Martinez FJ. Role of physiologic assessment in advanced interstitial lung disease. In: Maurer J, editor. Lung biology in health and disease series. Vol. 176. Management of non-neoplastic advanced lung disease. New York: Marcel Dekker; 2003. (In press)
100. Agusti C, Xaubet A, Agusti AG, Roca J, Ramirez J, Rodriguez-Roisin R. Clinical and functional assessment of patients with idiopathic pulmonary fibrosis: results of a 3 year follow-up. *Eur Respir J* 1994;7:643–650.
101. Xaubet A, Agusti C, Luburich P, Roca J, Monton C, Ayuso MC, Barbera JA, Rodriguez-Roisin R. Pulmonary function tests and CT scan in the management of idiopathic pulmonary fibrosis. *Am J Respir Crit Care Med* 1998;158:431–436.
102. Janicki JS, Weber KT, Likoff MJ, Fishman AP. Exercise testing to evaluate patients with pulmonary vascular disease. *Am Rev Respir Dis* 1984;129:S93–S95.
103. D'Alonzo GE, Gianotti L, Dantzker DR. Noninvasive assessment of hemodynamic improvement during chronic vasodilator therapy in obliterative pulmonary hypertension. *Am Rev Respir Dis* 1986;133:380–384.
104. Systrom DM, Cockrill BA, Hales CA. Exercise testing in patients with pulmonary vascular disease. In: Weisman IM, Zeballos RJ, editors. Clinical exercise testing. Basel, Switzerland: Karger; 2002. p. 200–204.
105. Sun XG, Hansen JR, Oudiz RJ, Wasserman K. Exercise pathophysiology in patients with primary pulmonary hypertension. *Circulation* 2001;104:429–435.
106. Miyamoto S, Nagaya N, Satoh T, Kyotani S, Sakamaki F, Fujita M, Nakanishi N, Miyatake K. Clinical correlates and prognostic significance of six-minute walk test in patients with primary pulmonary hypertension: comparison with cardiopulmonary exercise testing. *Am J Respir Crit Care Med* 2000;161:487–492.
107. Rubin LJ. Primary pulmonary hypertension. *Chest* 1993;104:236–250.
108. Rhodes J, Barst RJ, Garofano RP, Thoele DG, Gersony WM. Hemodynamic correlates of exercise function in patients with primary pulmonary hypertension. *J Am Coll Cardiol* 1991;18:1738–1744.
109. Nixon PA, Orenstein DM, Kelsey SF, Doershuk CF. The prognostic value of exercise testing in patients with cystic fibrosis. *N Engl J Med* 1992;327:1785–1788.
110. Moser C, Tirakitsoontorn P, Nussbaum E, Newcomb R, Cooper DM. Muscle size and cardiorespiratory response to exercise in cystic fibrosis. *Am J Respir Crit Care Med* 2000;162:1823–1827.
111. Sterk PJ, Fabbri LM, Quanjer PH, Cockcroft DW, O'Byrne PM, Anderson SD, Juniper EF, Malo JL. Airway responsiveness: standardized challenge testing with pharmacological, physical and sensitizing stimuli in adults. Report of Working Party Standardization of Lung Function Tests, European Community for Steel and Coal. Official statement of the European Respiratory Society. *Eur Respir J Suppl* 1993;16:53–83.
112. European Respiratory Society. Clinical exercise testing with reference to lung diseases: indications, standardization and interpretation strategies. ERS Task Force on Standardization of Clinical Exercise Testing. *Eur Respir J* 1997;10:2662–2689.
113. Roca J, Whipp BJ, editors. European Respiratory Society Monograph 6: Clinical Exercise Testing. Lausanne, Switzerland: European Respiratory Society; 1997. p. 164.
114. Garfinkel SK, Kesten S, Chapman KR, Rebuck AS. Physiologic and nonphysiologic determinants of aerobic fitness in mild to moderate asthma. *Am Rev Respir Dis* 1992;145:741–745.
115. Olsen GN. The evolving role of exercise testing before lung resection. *Chest* 1989;95:218–225.
116. Morice RC, Peters EJ, Ryan MB, Putnam JB, Ali MK, Roth JA. Exercise testing in the evaluation of patients at high risk for complications from lung resection [see comments]. *Chest* 1992;101:356–361.
117. Markos J, Mullan BP, Hillman DR, Musk AW, Antico VF, Lovegrove FT, Carter MJ, Finucane KE. Preoperative assessment as a predictor

- of mortality and morbidity after lung resection. *Am Rev Respir Dis* 1989;139:902-910.
118. Pierce RJ, Copland JM, Sharpe K, Barter CE. Preoperative risk evaluation for lung cancer resection: predicted postoperative product as a predictor of surgical mortality. *Am J Respir Crit Care Med* 1994;150:947-955.
 119. Becharh D, Wetstein L. Assessment of exercise oxygen consumption as preoperative criterion for lung resection. *Ann Thorac Surg* 1987;44:344-349.
 120. Smith TP, Kinasewitz GT, Tucker WY, Spillers WP, George RB. Exercise capacity as a predictor of post-thoracotomy morbidity. *Am Rev Respir Dis* 1984;129:730-734.
 121. Bolliger CT, Jordan P, Soler M, Stulz P, Gradel E, Skarvan K, Elsasser S, Gonon M, Wyser C, Tamm M, et al. Exercise capacity as a predictor of postoperative complications in lung resection candidates. *Am J Respir Crit Care Med* 1995;151:1472-1480.
 122. Bolliger CT, Perruchoud AP. Functional evaluation of the lung resection candidate. *Eur Respir J* 1998;11:198-212.
 123. Morice RC, Peters EJ, Ryan MB, Putnam JB, Ali MK, Roth JA. Redefining the lowest exercise peak oxygen consumption acceptable for lung resection of high risk patients. *Chest* 1996;110:161S.
 124. Bolliger CT, Wyser C, Roser H, Soler M, Perruchoud AP. Lung scanning and exercise testing for the prediction of postoperative performance in lung resection candidates at increased risk for complications. *Chest* 1995;108:341-348.
 125. Olsen GN. Lung cancer resection: who's inoperable? [editorial; see comments]. *Chest* 1995;108:298-299.
 126. Gilbreth EM, Weisman IM. Role of exercise stress testing in preoperative evaluation of patients for lung resection. *Clin Chest Med* 1994;15:389-403.
 127. Weisman IM. Cardiopulmonary exercise testing in the preoperative assessment for lung resection surgery. *Semin Thorac Cardiovasc Surg* 2001;13:116-125.
 128. Wyser C, Stulz P, Soler M, Tamm M, Muller-Brand J, Habicht J, Perruchoud AP, Bolliger CT. Prospective evaluation of an algorithm for the functional assessment of lung resection candidates. *Am J Respir Crit Care Med* 1999;159:1450-1456.
 129. Cordova F, O'Brien G, Furukawa S, Kuzma AM, Travaline J, Criner GJ. Stability of improvements in exercise performance and quality of life following bilateral lung volume reduction surgery in severe COPD. *Chest* 1997;112:907-915.
 130. Ferguson GT, Fernandez E, Zamora MR, Pomerantz M, Buchholz J, Make BJ. Improved exercise performance following lung volume reduction surgery for emphysema. *Am J Respir Crit Care Med* 1998;157:1195-1203.
 131. Benditt JO, Lewis S, Wood DE, Klima L, Albert RK. Lung volume reduction surgery improves maximal O₂ consumption, maximal minute ventilation, O₂ pulse, and dead space-to-tidal volume ratio during leg cycle ergometry. *Am J Respir Crit Care Med* 1997;156:561-566.
 132. Sciruba FC. Early and long-term functional outcomes following lung volume reduction surgery. *Clin Chest Med* 1997;18:259-276.
 133. Sciruba FC, Patel S. Functional evaluation in lung volume reduction surgery. In: Weisman IM, Zeballos RJ, editors. Progress in respiratory research. Vol. 32. Clinical exercise testing. Basel, Switzerland: Karger; 2002. p. 173-185.
 134. Wagner PD. Functional consequences of lung volume reduction surgery for COPD. *Am J Respir Crit Care Med* 1998;158:1017-1019.
 135. Oswald-Mammosser M, Kessler R, Massard G, Wihlm JM, Weitzenblum E, Lonsdorfer J. Effect of lung volume reduction surgery on gas exchange and pulmonary hemodynamics at rest and during exercise [see comments]. *Am J Respir Crit Care Med* 1998;158:1020-1025.
 136. Mineo TC, Pompeo E, Rogliani P, Dauri M, Turani F, Bollero P, Magliocchetti N. Effect of lung volume reduction surgery for severe emphysema on right ventricular function. *Am J Respir Crit Care Med* 2002;165:489-494.
 137. National Emphysema Treatment Trial Group. Patients at high risk of death after lung volume reduction surgery. *N Engl J Med* 2001;345:1075-1083.
 138. Howard DK, Iademarco EJ, Trulock EP. The role of cardiopulmonary exercise testing in lung and heart-lung transplantation. *Clin Chest Med* 1994;15:405-420.
 139. Williams RJ, Slater WR. Role of cardiopulmonary exercise in lung and heart-lung transplantation. In: Weisman IM, Zeballos RJ, editors. Progress in respiratory research. Vol. 32. Clinical exercise testing. Basel, Switzerland: Karger; 2002. p. 254-263.
 140. Braith RW, Edwards DG. Exercise following heart transplantation. *Sports Med* 2000;30:171-192.
 141. Wilson JR, Mancini DM. Factors contributing to the exercise limitation of heart failure. *J Am Coll Cardiol* 1993;22(4 Suppl A):93A-98A.
 142. Dempsey JA, Babcock MA. An integrative view of limitations to muscular performance. *Adv Exp Med Biol* 1995;384:393-399.
 143. Wagner PD. Determinants of maximal oxygen transport and utilization. *Annu Rev Physiol* 1996;58:21-50.
 144. Hall MJ, Snell GI, Side EA, Esmore DS, Walters EH, Williams TJ. Exercise, potassium, and muscle deconditioning post-thoracic organ transplantation. *J Appl Physiol* 1994;77:2784-2790.
 145. Williams TJ, Patterson GA, McClean PA, Zamel N, Maurer JR. Maximal exercise testing in single and double lung transplant recipients. *Am Rev Respir Dis* 1992;145:101-105.
 146. Evans AB, Al-Himyary AJ, Hrovat MI, Pappagianopoulos P, Wain JC, Ginns LC, Systrom DM. Abnormal skeletal muscle oxidative capacity after lung transplantation by ³¹P-MRS. *Am J Respir Crit Care Med* 1997;155:615-621.
 147. Schwaiblmair M, Reichenspurner H, Muller C, Briegel J, Furst H, Groh J, Reichart B, Vogelmeier C. Cardiopulmonary exercise testing before and after lung and heart-lung transplantation. *Am J Respir Crit Care Med* 1999;159:1277-1283.
 148. Kadikar A, Maurer J, Kesten S. The six-minute walk test: a guide to assessment for lung transplantation. *J Heart Lung Transplant* 1997;16:313-319.
 149. Orens JB, Becker FS, Lynch JP III, Christensen PJ, Deeb GM, Martinez FJ. Cardiopulmonary exercise testing following allogeneic lung transplantation for different underlying disease states. *Chest* 1995;107:144-149.
 150. Martinez FJ, Orens JB, Whyte RI, Graf L, Lynch JP III, Becker FS. Lung mechanics and dyspnea after lung transplantation for chronic airflow obstruction. *Am J Respir Crit Care Med* 1996;153:1536-1543.
 151. Sciruba FC, Owens GR, Sanders MH, Griffith BP, Hardesty RL, Paradis IL, Costantino JP. Evidence of an altered pattern of breathing during exercise in recipients of heart-lung transplants. *N Engl J Med* 1988;319:1186-1192.
 152. Older P, Smith R, Courtney P, Hone R. Preoperative evaluation of cardiac failure and ischemia in elderly patients by cardiopulmonary exercise testing [see comments]. *Chest* 1993;104:701-704.
 153. American Association of Cardiovascular and Pulmonary Rehabilitation. Pulmonary rehabilitation: joint ACCP/AACVPR evidence-based guidelines. ACCP/AACVPR Pulmonary Rehabilitation Guidelines Panel. *Chest* 1997;112:1363-1396.
 154. Ries AL. The importance of exercise in pulmonary rehabilitation. *Clin Chest Med* 1994;15:327-337.
 155. Casaburi R, Patessio A, Ioli F, Zanaboni S, Donner CF, Wasserman K. Reductions in exercise lactic acidosis and ventilation as a result of exercise training in patients with obstructive lung disease. *Am Rev Respir Dis* 1991;143:9-18.
 156. Stevens D, Elpern E, Sharma K, Szidon P, Ankin M, Kesten S. Comparison of hallway and treadmill six minute walk tests. *Am J Respir Crit Care Med* 1999;160:1540-1543.
 157. Ries AL, Kaplan RM, Limberg TM, Prewitt LM. Effects of pulmonary rehabilitation on physiologic and psychosocial outcomes in patients with chronic obstructive pulmonary disease. *Ann Intern Med* 1995;122:823-832.
 158. Casaburi R. Physiologic responses to training. *Clin Chest Med* 1994;15:215-227.
 159. Maltais F, LeBlanc P, Simard C, Jobin J, Berube C, Bruneau J, Carrier L, Belleau R. Skeletal muscle adaptation to endurance training in patients with chronic obstructive pulmonary disease. *Am J Respir Crit Care Med* 1996;154:442-447.
 160. Maltais F, LeBlanc P, Jobin J, Berube C, Bruneau J, Carrier L, Breton MJ, Falardeau G, Belleau R. Intensity of training and physiologic adaptation in patients with chronic obstructive pulmonary disease. *Am J Respir Crit Care Med* 1997;155:555-561.
 161. Casaburi R, Porszasz J, Burns MR, Carithers ER, Chang RS, Cooper CB. Physiologic benefits of exercise training in rehabilitation of patients with severe chronic obstructive pulmonary disease. *Am J Respir Crit Care Med* 1997;155:1541-1551.
 162. Sala E, Roca J, Marrades RM, Alonso J, Gonzalez De Suso JM, Moreno A, Barbera JA, Nadal J, de Jover L, Rodriguez-Roisin R, et al. Effects of endurance training on skeletal muscle bioenergetics in chronic obstructive pulmonary disease. *Am J Respir Crit Care Med* 1999;159:1726-1734.
 163. Rabinovich RA, Ardite E, Troosters T, Carbo N, Alonso J, Gonzalez de Suso JM, Vilaro J, Barbera JA, Polo MF, Argiles JM, et al. Reduced muscle redox capacity after endurance training in patients with chronic obstructive pulmonary disease. *Am J Respir Crit Care Med* 2001;164:1114-1118.

164. Reid MB. COPD as a muscle disease. *Am J Respir Crit Care Med* 2001; 164:1101-1102.
165. Bernard S, Whitton F, Leblanc P, Jobin J, Belleau R, Berube C, Carrier G, Maltais F. Aerobic and strength training in patients with chronic obstructive pulmonary disease. *Am J Respir Crit Care Med* 1999;159: 896-901.
166. Ortega F, Toral J, Cejudo P, Villagomez R, Sanchez H, Castillo J, Montemayor T. Comparison of effects of strength and endurance training in patients with chronic obstructive pulmonary disease. *Am J Respir Crit Care Med* 2002;166:669-674.
167. Becklake MR, Rodarte JR, Kalica AR. NHLBI workshop summary: scientific issues in the assessment of respiratory impairment. *Am Rev Respir Dis* 1988;137:1505-1510.
168. Cotes JE. Rating respiratory disability: a report on behalf of a working group of the European Society for Clinical Respiratory Physiology [see comments]. *Eur Respir J* 1990;3:1074-1077.
169. Cotes JE. Lung function: assessment and application in medicine, 5th ed. Oxford: Blackwell Scientific Publications; 1993. p. 54-58.
170. Smith DD. Pulmonary impairment/disability evaluation: controversies and criticisms. *Clin Pulm Med* 1995;2:334-343.
171. Sue DY. Exercise testing in the evaluation of impairment and disability. *Clin Chest Med* 1994;15:369-387.
172. Oren A, Sue DY, Hansen JE, Torrance DJ, Wasserman K. The role of exercise testing in impairment evaluation. *Am Rev Respir Dis* 1987; 135:230-235.
173. Sue DY, Oren A, Hansen JE, Wasserman K. Lung function and exercise performance in smoking and nonsmoking asbestos-exposed workers. *Am Rev Respir Dis* 1985;132:612-618.
174. Sue DY. Evaluation of impairment and disability: the role of cardiopulmonary exercise testing. In: Weisman IM, Zeballos RJ, editors. Clinical exercise testing. Basel, Switzerland: Karger; 2002. p. 217-230.
175. Agostoni P, Smith DD, Schoene RB, Robertson HT, Butler J. Evaluation of breathlessness in asbestos workers: results of exercise testing. *Am Rev Respir Dis* 1987;135:812-816.
176. Ortega F, Montemayor T, Sanchez A, Cabello F, Castillo J. Role of cardiopulmonary exercise testing and the criteria used to determine disability in patients with severe chronic obstructive pulmonary disease. *Am J Respir Crit Care Med* 1994;150:747-751.
177. Gordon EE. Energy costs of activities in health and disease. *Arch Intern Med* 1958;101:702-706.
178. Bruce RA. Exercise testing of patients with coronary heart disease: principles and normal standards for evaluation. *Ann Clin Res* 1971;3: 323-332.
179. Patterson JA, Naughton J, Pietras RJ, Gunnar RM. Treadmill exercise in assessment of the functional capacity of patients with cardiac disease. *Am J Cardiol* 1972;30:757-762.
180. Ellestad MH. Stress testing: principles and practice, 2nd ed. Philadelphia: F.A. Davis; 1980. p. ix.
181. Balke B, Ware RW. An experimental study of physical fitness of Air Force personnel. *US Armed Forces Med J* 1959;10:675-688.
182. Buchfuhrer MJ, Hansen JE, Robinson TE, Sue DY, Wasserman K, Whipp BJ. Optimizing the exercise protocol for cardiopulmonary assessment. *J Appl Physiol* 1983;55:1558-1564.
183. Åstrand P-O, Rodahl K. Textbook of work physiology: physiological bases of exercise, 2nd ed. New York: McGraw-Hill; 1977. p. xviii.
184. Hermansen L, Saltin B. Oxygen uptake during maximal treadmill and bicycle exercise. *J Appl Physiol* 1969;26:31-37.
185. McArdle WD, Katch FI, Pechar GS. Comparison of continuous and discontinuous treadmill and bicycle tests for max $\dot{V}O_2$. *Med Sci Sports* 1973;5:156-160.
186. McKay GA, Banister EW. A comparison of maximum oxygen uptake determination by bicycle ergometry at various pedaling frequencies and by treadmill running at various speeds. *Eur J Appl Physiol Occup Physiol* 1976;35:191-200.
187. Koyal SN, Whipp BJ, Huntsman D, Bray GA, Wasserman K. Ventilatory responses to the metabolic acidosis of treadmill and cycle ergometry. *J Appl Physiol* 1976;40:864-867.
188. Whipp BJ. The physiological and energetic basis of work efficiency. In: Bray GA, editor. Obesity in perspective. Washington, DC: U.S. Government Printing Office; 1976. p. 121-126.
189. Whipp BJ, Bray GA, Koyal SN, Wasserman K. Exercise energetics and respiratory control in man following acute and chronic evaluation of caloric intake. In: Bray GA, editor. Obesity in perspective. Washington, DC: U.S. Government Printing Office; 1976. p. 157-163.
190. Wasserman K, Whipp BJ. Exercise physiology in health and disease. *Am Rev Respir Dis* 1975;112:219-249.
191. Hellerstein HK. Specifications for exercise testing equipment. American Heart Association Subcommittee on Rehabilitation Target Activity Group. *Circulation* 1979;59:849A-854A.
192. Lanooy C, Bonjer FH. A hyperbolic ergometer for cycling and cranking. *J Appl Physiol* 1956;9:499-500.
193. Whipp BJ, Davis JA, Torres F, Wasserman K. A test to determine parameters of aerobic function during exercise. *J Appl Physiol* 1981; 50:217-221.
194. Davis JA, Whipp BJ, Lamarra N, Huntsman DJ, Frank MH, Wasserman K. Effect of ramp slope on determination of aerobic parameters from the ramp exercise test. *Med Sci Sports Exerc* 1982;14:339-343.
195. Hansen JE, Casaburi R, Cooper DM, Wasserman K. Oxygen uptake as related to work rate increment during cycle ergometer exercise. *Eur J Appl Physiol* 1988;57:140-145.
196. Zhang YY, Johnson MC, Chow N, Wasserman K. Effect of exercise testing protocol on parameters of aerobic function. *Med Sci Sports Exerc* 1991;23:625-630.
197. Myers J, Buchanan N, Walsh D, Kraemer M, McAuley P, Hamilton-Wessler M, Froelicher VF. Comparison of the ramp versus standard exercise protocols. *J Am Coll Cardiol* 1991;17:1334-1342.
198. Tanner CS, Heise CT, Barber G. Correlation of the physiologic parameters of a continuous ramp versus an incremental James exercise protocol in normal children. *Am J Cardiol* 1991;67:309-312.
199. Swain DP. Energy cost calculations for exercise prescription: an update. *Sports Med* 2000;30:17-22.
200. Londeree BR, Moffitt-Gerstenberger J, Padfield JA, Lottmann D. Oxygen consumption of cycle ergometry is nonlinearly related to work rate and pedal rate. *Med Sci Sports Exerc* 1997;29:775-780.
201. Casaburi R, Barstow TJ, Robinson T, Wasserman K. Dynamic and steady-state ventilatory and gas exchange responses to arm exercise. *Med Sci Sports Exerc* 1992;24:1365-1374.
202. Franklin BA, Vander L, Wrisley D, Rubenfire M. Aerobic requirements of arm ergometry: implications for exercise testing and training. *Physician Sportsmed* 1983;11:81-90.
203. Sawka MN. Physiology of upper body exercise. *Exerc Sport Sci Rev* 1986;14:175-211.
204. Martin TW, Zeballos RJ, Weisman IM. Gas exchange during maximal upper extremity exercise. *Chest* 1991;99:420-425.
205. Finucane KE, Egan BA, Dawson SV. Linearity and frequency response of pneumotachographs. *J Appl Physiol* 1972;32:121-126.
206. Miller MR, Pincock AC. Linearity and temperature control of the Fleisch pneumotachograph. *J Appl Physiol* 1986;60:710-715.
207. Yeh MP, Adams TD, Gardner RM, Yanowitz FG. Turbine flowmeter vs. Fleisch pneumotachometer: a comparative study for exercise testing. *J Appl Physiol* 1987;63:1289-1295.
208. Yoshiya I, Nakajima T, Nagai I, Jitsukawa S. A bidirectional respiratory flowmeter using the hot-wire principle. *J Appl Physiol* 1975;38:360-365.
209. Yoshiya I, Shimada Y, Tanaka K. Evaluation of a hot-wire respiratory flowmeter for clinical applicability. *J Appl Physiol* 1979;47:1131-1135.
210. Wasserman K, Hansen JE, Sue DY, Whipp BJ, Casaburi R. Principles of exercise testing and interpretation. Philadelphia: Lea & Febiger; 1987. p. xiii.
211. Porszasz J, Barstow TJ, Wasserman K. Evaluation of a symmetrically disposed Pitot tube flowmeter for measuring gas flow during exercise. *J Appl Physiol* 1994;77:2659-2665.
212. Cooper CB, Harris ND, Howard P. Evaluation of a turbine flow meter (Ventilometer Mark 2) in the measurement of ventilation. *Respiration* 1990;57:243-247.
213. Noguchi H, Ogushi Y, Yoshiya I, Itakura N, Yamabayashi H. Breath-by-breath $\dot{V}CO_2$ and $\dot{V}O_2$ required compensation for transport delay and dynamic response. *Journal of Applied Physiology: Respiratory. Environ Exerc Physiol* 1982;52:79-84.
214. Yamamoto Y, Takei Y, Mokushi K, Morita H, Mutoh Y, Miyashita M. Breath-by-breath measurement of alveolar gas exchange with a slow-response gas analyser. *Med Biol Eng Comput* 1987;25:141-146.
215. Beaver WL. Water vapor corrections in oxygen consumption calculations. *J Appl Physiol* 1973;35:928-931.
216. Mogue LR, Rantala B. Capnometers. *J Clin Monit* 1988;4:115-121.
217. Consolazio CF. Physiological measurements of metabolic functions in man. New York: McGraw-Hill, Blakiston Division; 1963. p. 505.
218. Astrup P, Severinghaus JW. The history of blood gases, acids and bases, 1st ed. Copenhagen: Munksgaard; 1986. p. x.
219. Poole GW, Maskell RC. Validation of continuous determination of respired gases during steady-state exercise. *J Appl Physiol* 1975;38: 736-738.
220. Spiro SG, Juniper E, Bowman P, Edwards RH. An increasing work rate test for assessing the physiological strain of submaximal exercise. *Clin Sci Mol Med* 1974;46:191-206.

221. Jones NL. Evaluation of a microprocessor-controlled exercise testing system. *J Appl Physiol* 1984;57:1312-1318.
222. Hughson RL, Kowalchuk JM, Prime WM, Green HJ. Open-circuit gas exchange analysis in the non-steady-state. *Can J Appl Sport Sci* 1980; 5:15-18.
223. Beaver WL, Wasserman K, Whipp BJ. On-line computer analysis and breath-by-breath graphical display of exercise function tests. *J Appl Physiol* 1973;34:128-134.
224. Lamarra N, Whipp BJ. Measurements of pulmonary gas exchange. In: Maud PJ, Foster C, editors. Physiological assessment of human fitness. Champaign, IL: Human Kinetics; 1995. p. 19-35.
225. Beaver WL, Lamarra N, Wasserman K. Breath-by-breath measurement of true alveolar gas exchange. *J Appl Physiol* 1981;51:1662-1675.
226. Sherrill DL, Swanson GD. Application of the general linear model for smoothing gas exchange data. *Comput Biomed Res* 1989;22:270-281.
227. Swanson G. Breath-to-breath considerations for gas exchange kinetics. In: Cerretelli P, Whipp BJ, editors. Exercise, bioenergetics and gas exchange. Amsterdam: Elsevier/North Holland; 1980. p. 211-222.
228. Matthews JI, Bush BA, Morales FM. Microprocessor exercise physiology systems vs a nonautomated system: a comparison of data output. *Chest* 1987;92:696-703.
229. Myers J, Walsh D, Sullivan M, Froelicher V. Effect of sampling on variability and plateau in oxygen uptake. *J Appl Physiol* 1990;68:404-410.
230. Scuirba FC, Owens GR, Ondrizek J. The effect of sample interval on maximal values obtained during incremental exercise. *Am Rev Respir Dis* 1991;143:A176.
231. Ben-Dov I, Sietsema KE, Casaburi R, Wasserman K. Evidence that circulatory oscillations accompany ventilatory oscillations during exercise in patients with heart failure. *Am Rev Respir Dis* 1992;145:776-781.
232. Slivka WA, Scuirba FC. Parameters and power to measure a therapeutic effect (lung reduction surgery—LVRS) in advanced emphysema [abstract]. *Am J Respir Crit Care Med* 1998;157:A92.
233. Mason RE, Likar I. A new system of multiple-lead exercise electrocardiography. *Am Heart J* 1966;71:196-205.
234. Ramsey M III. Blood pressure monitoring: automated oscillometric devices. *J Clin Monit* 1991;7:56-67.
235. Hansen JE, Sue DY, Wasserman K. Predicted values for clinical exercise testing. *Am Rev Respir Dis* 1984;129:S49-S55.
236. Robinson TE, Sue DY, Huszczuk A, Weiler-Ravell D, Hansen JE. Intra-arterial and cuff blood pressure responses during incremental cycle ergometry. *Med Sci Sports Exerc* 1988;20:142-149.
237. Clark JS, Votteri B, Ariagno RL, Cheung P, Eichhorn JH, Fallat RJ, Lee SE, Newth CJ, Rotman H, Sue DY. Noninvasive assessment of blood gases. *Am Rev Respir Dis* 1992;145:220-232.
238. Council on Scientific Affairs, American Medical Association. The use of pulse oximetry during conscious sedation. *JAMA* 1993;270:1463-1468.
239. Tobin MJ. Respiratory monitoring. *JAMA* 1990;264:244-251.
240. Ries AL, Farrow JT, Clausen JL. Accuracy of two ear oximeters at rest and during exercise in pulmonary patients. *Am Rev Respir Dis* 1985;132:685-689.
241. Severinghaus JW, Naifeh KH, Koh SO. Errors in 14 pulse oximeters during profound hypoxia. *J Clin Monit* 1989;5:72-81.
242. Zeballos RJ, Weisman IM. Reliability of noninvasive oximetry in black subjects during exercise and hypoxia. *Am Rev Respir Dis* 1991;144: 1240-1244.
243. Carlin BW, Clausen JL, Ries AL. The use of cutaneous oximetry in the prescription of long-term oxygen therapy. *Chest* 1988;94:239-241.
244. Orenstein DM, Curtis SE, Nixon PA, Hartigan ER. Accuracy of three pulse oximeters during exercise and hypoxemia in patients with cystic fibrosis. *Chest* 1993;104:1187-1190.
245. Hansen JE, Casaburi R. Validity of ear oximetry in clinical exercise testing. *Chest* 1987;91:333-337.
246. Ries AL, Prewitt LM, Johnson JJ. Skin color and ear oximetry. *Chest* 1989;96:287-290.
247. Beck KC, Weisman IM. Methods for cardiopulmonary exercise testing. In: Weisman IM, Zeballos RJ, editors. Clinical exercise testing. Basel, Switzerland: Karger; 2002. p. 43-59.
248. Bradley P. A model for gas-exchange simulation. *J Cardiovasc Pulm Tech* 1983;11:33-39.
249. Huszczuk A, Whipp BJ, Wasserman K. A respiratory gas exchange simulator for routine calibration in metabolic studies. *Eur Respir J* 1990;3:465-468.
250. Gore CJ, Catcheside PG, French SN, Bennett JM, Laforgia J. Automated \dot{V}_{O_2} max calibrator for open-circuit indirect calorimetry systems. *Med Sci Sports Exerc* 1997;29:1095-1103.
251. Clark JH, Greenleaf JE. Electronic bicycle ergometer: a simple calibration procedure. *J Appl Physiol* 1971;30:440-442.
252. Van Praagh E, Bedu M, Roddier P, Coudert J. A simple calibration method for mechanically braked cycle ergometers. *Int J Sports Med* 1992;13:27-30.
253. Russell JC, Dale JD. Dynamic torque calibration of bicycle ergometers. *J Appl Physiol* 1986;61:1217-1220.
254. Revill SM, Morgan MD. Biological quality control for exercise testing. *Thorax* 2000;55:63-66.
255. Garrard CS, Emmons C. The reproducibility of the respiratory responses to maximum exercise. *Respiration* 1986;49:94-100.
256. Wilson RC, Jones PW. Long-term reproducibility of Borg Scale estimates of breathlessness during exercise. *Clin Sci* 1991;80:309-312.
257. Nordrehaug JE, Danielsen R, Stangeland L, Rosland GA, Vik-Mo H. Respiratory gas exchange during treadmill exercise testing: reproducibility and comparison of different exercise protocols. *Scand J Clin Lab Invest* 1991;51:655-658.
258. Swinburn CR, Wakefield JM, Jones PW. Performance, ventilation, and oxygen consumption in three different types of exercise test in patients with chronic obstructive lung disease. *Thorax* 1985;40:581-586.
259. Noseda A, Carpioux JP, Prigogine T, Schmerber J. Lung function, maximum and submaximum exercise testing in COPD patients: reproducibility over a long interval. *Lung* 1989;167:247-257.
260. Owens MW, Kinasewitz GT, Strain DS. Evaluating the effects of chronic therapy in patients with irreversible air-flow obstruction. *Am Rev Respir Dis* 1986;134:935-937.
261. Belman MJ, Brooks LR, Ross DJ, Mohsenifar Z. Variability of breathlessness measurement in patients with chronic obstructive pulmonary disease. *Chest* 1991;99:566-571.
262. Cox NJ, Hendriks JC, Binkhorst RA, Folgering HT, van Herwaarden CL. Reproducibility of incremental maximal cycle ergometer tests in patients with mild to moderate obstructive lung diseases. *Lung* 1989;167:129-133.
263. Brown SE, Fischer CE, Stansbury DW, Light RW. Reproducibility of \dot{V}_{O_2} max in patients with chronic air-flow obstruction. *Am Rev Respir Dis* 1985;131:435-438.
264. Marciniuk DD, Watts RE, Gallagher CG. Reproducibility of incremental maximal cycle ergometer testing in patients with restrictive lung disease. *Thorax* 1993;48:894-898.
265. Elborn JS, Stanford CF, Nicholls DP. Reproducibility of cardiopulmonary parameters during exercise in patients with chronic cardiac failure: the need for a preliminary test. *Eur Heart J* 1990;11:75-81.
266. Janicki JS, Gupta S, Ferris ST, McElroy PA. Long-term reproducibility of respiratory gas exchange measurements during exercise in patients with stable cardiac failure. *Chest* 1990;97:12-17.
267. Meyer K, Westbrook S, Schwaibold M, Hajric R, Peters K, Roskamm H. Short-term reproducibility of cardiopulmonary measurements during exercise testing in patients with severe chronic heart failure. *Am Heart J* 1997;134:20-26.
268. Guyatt GH, Pugsley SO, Sullivan MJ, Thompson PJ, Berman L, Jones NL, Fallen EL, Taylor DW. Effect of encouragement on walking test performance. *Thorax* 1984;39:818-822.
269. Zeballos RJ, Weisman IM. Behind the scenes of cardiopulmonary exercise testing. *Clin Chest Med* 1994;15:193-213.
270. Jones NL. Pulmonary gas exchange during exercise in patients with chronic airway obstruction. *Clin Sci* 1966;31:39-50.
271. Owens GR, Rogers RM, Pennock BE, Levin D. The diffusing capacity as a predictor of arterial oxygen desaturation during exercise in patients with chronic obstructive pulmonary disease. *N Engl J Med* 1984;310:1218-1221.
272. Lewis DA, Sietsema KE, Casaburi R, Sue DY. Inaccuracy of noninvasive estimates of \dot{V}_D/\dot{V}_T in clinical exercise testing. *Chest* 1994;106: 1476-1480.
273. Zimmerman MI, Miller A, Brown LK, Bhuptani A, Sloane MF, Teirstein AS. Estimated vs actual values for dead space/tidal volume ratios during incremental exercise in patients evaluated for dyspnea. *Chest* 1994;106:131-136.
274. Ries AL, Fedullo PF, Clausen JL. Rapid changes in arterial blood gas levels after exercise in pulmonary patients. *Chest* 1983;83:454-456.
275. Zeballos RJ, Weisman IM, Connery SM. Comparison of pulmonary gas exchange measurements between incremental and constant work exercise above the anaerobic threshold. *Chest* 1998;113:602-611.
276. Weisman IM, Zeballos RJ. Integrative approach to the interpretation of cardiopulmonary exercise testing. In: Weisman IM, Zeballos RJ, editors. Progress in respiratory research. Vol. 32. Clinical exercise testing. Basel, Switzerland: Karger; 2002. p. 300-322.
277. Andersen KL, Shepard RJ, Denolin H, Varnauskas E, Masironi R. Fundamentals of exercise testing. Geneva, Switzerland: World Health Organization; 1971. p. 138.
278. Arstila M. Pulse-conducted triangular exercise-ECG test: a feed-back

- system regulating work during exercise. *Acta Med Scand Suppl* 1972; 529:3-109.
279. Northridge DB, Grant S, Ford I, Christie J, McLenachan J, Connelly D, McMurray J, Ray S, Henderson E, Dargie HJ. Novel exercise protocol suitable for use on a treadmill or a bicycle ergometer. *Br Heart J* 1990;64:313-316.
 280. Riley M, Northridge DB, Henderson E, Stanford CF, Nicholls DP, Dargie HJ. The use of an exponential protocol for bicycle and treadmill exercise testing in patients with chronic cardiac failure. *Eur Heart J* 1992;13:1363-1367.
 281. Lollgen H, Ulmer H-V, Crean P, editors. Recommendations and standard guidelines for exercise testing. Report of the Task Force Conference on Ergometry, Titisee 1987. *Eur Heart J* 1988;(9 Suppl K):1-37.
 282. Bruce RA, McDonough JR. Stress testing in screening for cardiovascular disease. *Bull N Y Acad Med* 1969;45:1288-1305.
 283. Naughton JP, Hellerstein HK, Haider R. Methods of exercise testing. In: Exercise testing and exercise training in coronary heart disease. New York: Academic Press; 1973. p. xx.
 284. Nagle FJ, Balke B, Naughton JP. Gradational step tests for assessing work capacity. *J Appl Physiol* 1965;20:745-748.
 285. Pollock ML, Wilmore JH, Fox SM. Exercise in health and disease: evaluation and prescription for prevention and rehabilitation. Philadelphia: W. B. Saunders; 1984. p. viii.
 286. Janicki JS, Weber KT. Equipment and protocols to evaluate patients with pulmonary vascular disease. In: Weber KT, Janicki JS, editors. Cardio-pulmonary testing. Philadelphia: W. B. Saunders; 1986. p. 138-150.
 287. Myers J, Prakash M, Froelicher V, Do D, Partington S, Atwood E. Exercise capacity and mortality among men referred for exercise testing. *N Eng J Med* 2002;346:793-801.
 288. Johnson BD, Weisman IM, Zeballos RJ, Beck KC. Emerging concepts in the evaluation of ventilatory limitation during exercise: the exercise tidal flow-volume loop. *Chest* 1999;116:488-503.
 289. Whipp BJ, Wasserman K. Oxygen uptake kinetics for various intensities of constant-load work. *J Appl Physiol* 1972;33:351-356.
 290. Nery LE, Wasserman K, Andrews JD, Huntsman DJ, Hansen JE, Whipp BJ. Ventilatory and gas exchange kinetics during exercise in chronic airways obstruction. *J Appl Physiol* 1982;53:1594-1602.
 291. Whipp BJ, Ward SA, Lamarra N, Davis JA, Wasserman K. Parameters of ventilatory and gas exchange dynamics during exercise. *J Appl Physiol* 1982;52:1506-1513.
 292. American College of Sports Medicine. ACSM's guidelines for exercise testing and prescription, 5th ed. Baltimore: Williams & Wilkins; 1995. p. xvi.
 293. Gamble P, McManus H, Jensen D, Froelicher V. A comparison of the standard 12-lead electrocardiogram to exercise electrode placements. *Chest* 1984;85:616-622.
 294. Stuart RJ Jr, Ellestad MH. National survey of exercise stress testing facilities. *Chest* 1980;77:94-97.
 295. American College of Sports Medicine. Guidelines for exercise testing and prescription, 4th ed. Philadelphia: Lea & Febiger; 1991. p. xv.
 296. Scherer D, Kaltenbach M. [Frequency of life-threatening complications associated with exercise testing (author's translation)]. *Dtsch Med Wochenschr* 1979;104:1161-1165.
 297. Douard H, Mora B, Broustet JP. Epreuve d'effort et tachycardies ventriculaires: l'expérience Française. *Arch Mal Coeur Vaiss* 1987;80: 263-270.
 298. Myers J, Voodi L, Umann T, Froelicher VF. A survey of exercise testing: methods, utilization, interpretation, and safety in the VAHCS. *J Cardiopulm Rehabil* 2000;20:251-258.
 299. Rochmis P, Blackburn H. Exercise tests: a survey of procedures, safety, and litigation experience in approximately 170,000 tests. *JAMA* 1971;217:1061-1066.
 300. D'Alonzo GE, Barst RJ, Ayres SM, Bergofsky EH, Detre KM, Brundage BH, Detre KM, Fishman AP, Goldring RM, Groves BM, et al. Survival in patients with primary pulmonary hypertension: results from a national prospective registry. *Ann Intern Med* 1991;115:343-349.
 301. Whipp BJ, Davis JA. The ventilatory stress of exercise in obesity. *Am Rev Respir Dis* 1984;129:S90-S92.
 302. Dempsey J, Reddan W, Balke B, Rankin J. Work capacity determinants and physiologic cost of weight-supported work in obesity. *J Appl Physiol* 1966;21:1815-1820.
 303. Myers J, Walsh D, Buchanan N, Froelicher VF. Can maximal cardiopulmonary capacity be recognized by a plateau in oxygen uptake? *Chest* 1989;96:1312-1316.
 304. Noakes TD. Maximal oxygen uptake: "classical" versus "contemporary" viewpoints: a rebuttal. *Med Sci Sports Exerc* 1998;30:1381-1398.
 305. Åstrand P-O, Rodahl K. Textbook of work physiology: physiological bases of exercise, 3rd ed. McGraw-Hill series in health education, physical education, and recreation. New York: McGraw Hill; 1986. xii.
 306. Rosen MJ, Sorkin JD, Goldberg AP, Hagberg JM, Katzell LI. Predictors of age-associated decline in maximal aerobic capacity: a comparison of four statistical models. *J Appl Physiol* 1998;84:2163-2170.
 307. Treuth MS, Figueroa-Colon R, Hunter GR, Weinsier RL, Butte NF, Goran MI. Energy expenditure and physical fitness in overweight vs non-overweight prepupal girls. *Int J Obes Relat Metab Disord* 1998;22:440-447.
 308. Weller JJ, El-Gamal FM, Parker L, Reed JW, Cotes JE. Indirect estimation of maximal oxygen uptake for study of working populations. *Br J Ind Med* 1988;45:532-537.
 309. Johnson BD, Saupe KW, Dempsey JA. Mechanical constraints on exercise hyperpnea in endurance athletes. *J Appl Physiol* 1992;73:874-886.
 310. Jones NL, Killian KJ. Exercise limitation in health and disease. *N Engl J Med* 2000;343:632-641.
 311. Brooks GA. Anaerobic threshold: review of the concept and directions for future research. *Med Sci Sports Exerc* 1985;17:22-34.
 312. Davis JA. Anaerobic threshold: review of the concept and directions for future research. *Med Sci Sports Exerc* 1985;17:6-21.
 313. Brooks GA. Current concepts in lactate exchange. *Med Sci Sports Exerc* 1991;23:895-906.
 314. Myers J, Ashley E. Dangerous curves: a perspective on exercise, lactate, and the anaerobic threshold. *Chest* 1997;111:787-795.
 315. Wasserman K, Beaver WL, Whipp BJ. Gas exchange theory and the lactic acidosis (anaerobic) threshold. *Circulation* 1990;81(1 Suppl): II14-II30.
 316. Sue DY, Wasserman K, Moricca RB, Casaburi R. Metabolic acidosis during exercise in patients with chronic obstructive pulmonary disease. Use of the V-slope method for anaerobic threshold determination. *Chest* 1988;94:931-938.
 317. Dickstein K, Barvik S, Aarland T, Snapinn S, Karlsson J. A comparison of methodologies in detection of the anaerobic threshold. *Circulation* 1990;81(1 Suppl):II38-II46.
 318. Matsumura N, Nishijima H, Kojima S, Hashimoto F, Minami M, Yasuda H. Determination of anaerobic threshold for assessment of functional state in patients with chronic heart failure. *Circulation* 1983;68:360-367.
 319. Patessio A, Casaburi R, Carone M, Appendini L, Donner CF, Wasserman K. Comparison of gas exchange, lactate, and lactic acidosis thresholds in patients with chronic obstructive pulmonary disease. *Am Rev Respir Dis* 1993;148:622-626.
 320. Simonton CA, Higginbotham MB, Cobb FR. The ventilatory threshold: quantitative analysis of reproducibility and relation to arterial lactate concentration in normal subjects and in patients with chronic congestive heart failure. *Am J Cardiol* 1988;62:100-107.
 321. Hughson RL, Green HJ. Blood acid-base and lactate relationships studied by ramp work tests. *Med Sci Sports Exerc* 1982;14:297-302.
 322. Hughson RL, Weisiger KH, Swanson GD. Blood lactate concentration increases as a continuous function in progressive exercise. *J Appl Physiol* 1987;62:1975-1981.
 323. Johnson BD, Beck KC. Respiratory system responses to dynamic exercise. In: Weiler JM, editor. Allergic and respiratory disease in sports medicine. New York: Marcel Dekker; 1997. p. 1-34.
 324. Dempsey JA, Adams L, Ainsworth DM, Fregosi RF, Gallagher CG, Guz A, Johnson BD, Powers SK. Airway, lung and respiratory muscle function during exercise. In: Rowell LB, Shepard JT, editors. Handbook of physiology. Section 12. Exercise: regulation and integration of multiple systems. New York: Oxford University Press; 1996. p. 448-514.
 325. Agostoni P, Assanelli E, Guazzi M, Grazi M, Perego GB, Lomanto M, Cattadori G, Lauri G, Marenzi G. [Mechanisms facilitating oxygen delivery during exercise in patients with chronic heart failure]. *Cardiology* 1997;42:743-750.
 326. Wasserman K, Zhang YY, Gitt A, Belardinelli R, Koike A, Lubarsky L, Agostoni PG. Lung function and exercise gas exchange in chronic heart failure. *Circulation* 1997;96:2221-2227.
 327. Dennis SC, Noakes TD, Bosch AN. Ventilation and blood lactate increase exponentially during incremental exercise. *J Sports Sci* 1992; 10:437-449.
 328. Myers J, Walsh D, Buchanan N, McAuley P, Bowes E, Froelicher V. Increase in blood lactate during ramp exercise: comparison of continuous and threshold models. *Med Sci Sports Exerc* 1994;26:1413-1419.
 329. Sullivan CS, Casaburi R, Storer TW, Wasserman K. Non-invasive prediction of blood lactate response to constant power outputs from incremental exercise tests. *Eur J Appl Physiol Occup Physiol* 1995; 71:349-354.

330. Belman MJ, Epstein LJ, Doornbos D, Elashoff JD, Koerner SK, Mohsenifar Z. Noninvasive determinations of the anaerobic threshold: reliability and validity in patients with COPD. *Chest* 1992;102:1028-1034.
331. Robergs RA, Chwalbinska-Moneta J, Mitchell JB, Pascoe DD, Hounard J, Costill DL. Blood lactate threshold differences between arterialized and venous blood. *Int J Sports Med* 1990;11:446-451.
332. Davis HA, Bassett J, Hughes P, Gass GC. Anaerobic threshold and lactate turnpoint. *Eur J Appl Physiol* 1983;50:383-392.
333. Simon J, Young JL, Blood DK, Segal KR, Case RB, Gutin B. Plasma lactate and ventilation thresholds in trained and untrained cyclists. *J Appl Physiol* 1986;60:777-781.
334. McLoughlin P, Popham P, Linton RA, Bruce RC, Band DM. Use of arterialized venous blood sampling during incremental exercise tests. *J Appl Physiol* 1992;73:937-940.
335. Wasserman K, Beaver WL, Whipp BJ. Mechanisms and patterns of blood lactate increase during exercise in man. *Med Sci Sports Exerc* 1986;18:344-352.
336. Beaver WL, Wasserman K, Whipp BJ. Improved detection of lactate threshold during exercise using a log-log transformation. *J Appl Physiol* 1985;59:1936-1940.
337. Bishop D, Jenkins DG, Mackinnon LT. The relationship between plasma lactate parameters, Wpeak and 1-h cycling performance in women. *Med Sci Sports Exerc* 1998;30:1270-1275.
338. Tokmakidis SP, Leger LA, Piliandis TC. Failure to obtain a unique threshold on the blood lactate concentration curve during exercise. *Eur J Appl Physiol Occup Physiol* 1998;77:333-342.
339. Beaver WL, Wasserman K, Whipp BJ. Bicarbonate buffering of lactic acid generated during exercise. *J Appl Physiol* 1986;60:472-478.
340. Beaver WL, Wasserman K, Whipp BJ. A new method for detecting anaerobic threshold by gas exchange. *J Appl Physiol* 1986;60:2020-2027.
341. Ozelik O, Ward SA, Whipp BJ. Effect of altered body CO₂ stores on pulmonary gas exchange dynamics during incremental exercise in humans. *Exp Physiol* 1999;84:999-1011.
342. Caiozzo VJ, Davis JA, Ellis JF, Azus JL, Vandagriff R, Prietto CA, McMaster WC. A comparison of gas exchange indices used to detect the anaerobic threshold. *J Appl Physiol* 1982;53:1184-1189.
343. Gladden LB, Yates JW, Stremel RW, Stamford BA. Gas exchange and lactate anaerobic thresholds: inter- and intraevaluator agreement. *J Appl Physiol* 1985;58:2082-2089.
344. Yeh MP, Gardner RM, Adams TD, Yanowitz FG, Crapo RO. "Anaerobic threshold": problems of determination and validation. *J Appl Physiol* 1983;55:1178-1186.
345. Lange-Andersen K, Shepard RJ, Denolin H, Varnauskas E, Masironi R. Fundamentals of exercise testing. Geneva, Switzerland: World Health Organization; 1971.
346. Graves JE, Pollock ML, Swart D, Pantone LB, Garzarella L, Lowenthal DT, Limacher M, Menglekoeh L. Does 220 - age accurately predict maximal heart rate in the elderly? *Med Sci Sports Exerc* 1993;25:S186.
347. Pianosi P, Pelech A. Stroke volume during exercise in cystic fibrosis. *Am J Respir Crit Care Med* 1996;153:1105-1109.
348. Eschenbacher WL, Mannina A. An algorithm for the interpretation of cardiopulmonary exercise tests. *Chest* 1990;97:263-267.
349. Whipp BJ, Higgenbotham MB, Cobb FC. Estimating exercise stroke volume from asymptotic oxygen pulse in humans. *J Appl Physiol* 1996;81:2674-2679.
350. Stringer WW, Hansen JE, Wasserman K. Cardiac output estimated noninvasively from oxygen uptake during exercise. *J Appl Physiol* 1997;82:908-912.
351. Agostoni PG, Wasserman K, Perego GB, Guazzi M, Cattadori G, Palermo P, Lauri G, Marenzi G. Non-invasive measurement of stroke volume during exercise in heart failure patients. *Clin Sci* 2000;98:545-551.
352. Hansen JE, Wasserman K. Pathophysiology of activity limitation in patients with interstitial lung disease. *Chest* 1996;109:1566-1576.
353. Gallagher CG, Brown E, Younes M. Breathing pattern during maximal exercise and during submaximal exercise with hypercapnia. *J Appl Physiol* 1987;63:238-244.
354. Hey EN, Lloyd BB, Cunningham DJ, Jukes MG, Bolton DP. Effects of various respiratory stimuli on the depth and frequency of breathing in man. *Respir Physiol* 1966;1:193-205.
355. Younes M, Kivinen G. Respiratory mechanics and breathing pattern during and following maximal exercise. *J Appl Physiol* 1984;57:1773-1782.
356. Blackie SP, Fairbairn MS, McElvaney NG, Wilcox PG, Morrison NJ, Pardy RL. Normal values and ranges for ventilation and breathing pattern at maximal exercise. *Chest* 1991;100:136-142.
357. Jensen JI, Lyager S, Pedersen OF. The relationship between maximal ventilation, breathing pattern and mechanical limitation of ventilation. *J Physiol* 1980;309:521-532.
358. Henke KG, Sharratt M, Pegelow D, Dempsey JA. Regulation of end-expiratory lung volume during exercise. *J Appl Physiol* 1988;64:135-146.
359. Dempsey JA, Johnson BD. Demand vs. capacity in the healthy pulmonary system. *Schweiz Z Sportmed* 1992;40:55-64.
360. Road J, Newman S, Derenne JP, Grassino A. In vivo length-force relationship of canine diaphragm. *J Appl Physiol* 1986;60:63-70.
361. McParland C, Krishnan B, Lobo J, Gallagher CG. Effect of physical training on breathing pattern during progressive exercise. *Respir Physiol* 1992;90:311-323.
362. Syabbalo NC, Zintel T, Watts R, Gallagher CG. Carotid chemoreceptors and respiratory adaptations to dead space loading during incremental exercise. *J Appl Physiol* 1993;75:1378-1384.
363. Klas JV, Dempsey JA. Voluntary versus reflex regulation of maximal exercise flow: volume loops. *Am Rev Respir Dis* 1989;139:150-156.
364. Campbell SC. A comparison of the maximum voluntary ventilation with the forced expiratory volume in one second: an assessment of subject cooperation. *J Occup Med* 1982;24:531-533.
365. Mancini DM, Henson D, LaManca J, Levine S. Respiratory muscle function and dyspnea in patients with chronic congestive heart failure. *Circulation* 1992;86:909-918.
366. Gosselink R, Kovaacs L, Ketelaer P, Carton H, Decramer M. Respiratory muscle weakness and respiratory muscle training in severely disabled multiple sclerosis patients. *Arch Phys Med Rehabil* 2000;81:747-751.
367. Archer GJ, Hoyle JL, McCluskey A, Macdonald J. Inspiratory vocal cord dysfunction, a new approach in treatment. *Eur Respir J* 2000;15:617-618.
368. Johnson BD, Badr MS, Dempsey JA. Impact of the aging pulmonary system on the response to exercise. *Clin Chest Med* 1994;15:229-246.
369. Montes de Oca M, Celli BR. Respiratory muscle recruitment and exercise performance in eucapnic and hypercapnic severe chronic obstructive pulmonary disease. *Am J Respir Crit Care Med* 2000;161:880-885.
370. Lopata M, Freilich RA, Onal E, Pearle J, Lourenco RV. Ventilatory control and the obesity hypoventilation syndrome. *Am Rev Respir Dis* 1979;119:165-168.
371. Whipp BJ, Davis JA, Wasserman K. Ventilatory control of the "isocapnic buffering" region in rapidly-incremental exercise. *Respir Physiol* 1989;76:357-367.
372. Johnson BD, Beck KC, Zeballos RJ, Weisman IM. Advances in pulmonary laboratory testing. *Chest* 1999;116:1377-1387.
373. Grimby G, Saltin B, Wilhelmsen L. Pulmonary flow-volume and pressure-volume relationship during submaximal and maximal exercise in young well-trained men. *Bull Physiopathol Respir (Nancy)* 1971;7:157-172.
374. Babb TG. Mechanical ventilatory constraints in aging, lung disease, and obesity: perspectives and brief review. *Med Sci Sports Exerc* 1999;31(1 Suppl):S12-S22.
375. Leaver DG, Pride NB. Flow-volume curves and expiratory pressures during exercise in patients with chronic airways obstruction. *Scand J Respir Dis* 1971;77:23-27.
376. DeLorey DS, Babb TG. Progressive mechanical ventilatory constraints with aging. *Am J Respir Crit Care Med* 1999;160:169-177.
377. Johnson BD, Scanlon PD, Beck KC. Regulation of ventilatory capacity during exercise in asthmatics. *J Appl Physiol* 1995;79:892-901.
378. Marciniuk DD, Sridhar G, Clemens RE, Zintel TA, Gallagher CG. Lung volumes and expiratory flow limitation during exercise in interstitial lung disease. *J Appl Physiol* 1994;77:963-973.
379. Koulouris NG, Valta P, Lavoie A, Corbeil C, Chasse M, Braidly J, Milic-Emili J. A simple method to detect expiratory flow limitation during spontaneous breathing. *Eur Respir J* 1995;8:306-313.
380. Koulouris NG, Dimopoulou I, Valta P, Finkelstein R, Cosio MG, Milic-Emili J. Detection of expiratory flow limitation during exercise in COPD patients. *J Appl Physiol* 1997;82:723-731.
381. Johnson BD, Reddan WG, Seow KC, Dempsey JA. Mechanical constraints on exercise hyperpnea in a fit aging population. *Am Rev Respir Dis* 1991;143:968-977.
382. Clark JM, Sinclair RD, Lenox JB. Chemical and nonchemical components of ventilation during hypercapnic exercise in man. *J Appl Physiol* 1980;48:1065-1076.
383. Mancini D, Donchez L, Levine S. Acute unloading of the work of breathing extends exercise duration in patients with heart failure. *J Am Coll Cardiol* 1997;29:590-596.
384. Babb TG. Ventilatory response to exercise in subjects breathing CO₂ or HeO₂. *J Appl Physiol* 1997;82:746-754.
385. Krishnan BS, Clemens RE, Zintel TA, Stockwell MJ, Gallagher CG. Ventilatory response to helium-oxygen breathing during exercise: effect of airway anesthesia. *J Appl Physiol* 1997;83:82-88.

386. Babb TG. Breathing He-O₂ increases ventilation but does not decrease the work of breathing during exercise. *Am J Respir Crit Care Med* 2001;163:1128-1134.
387. Black LF, Hyatt RE. Maximal respiratory pressures: normal values and relationship to age and sex. *Am Rev Respir Dis* 1969;99:696-702.
388. American Thoracic Society, European Respiratory Society. Statement on respiratory muscle testing. *Am J Respir Crit Care Med* 2002;166:518-624.
389. Leblanc P, Summers E, Inman MD, Jones NL, Campbell EJ, Killian KJ. Inspiratory muscles during exercise: a problem of supply and demand. *J Appl Physiol* 1988;64:2482-2489.
390. West JB. Ventilation/blood flow and gas exchange, 5th ed. Oxford: Blackwell Scientific [distributed by Year Book (Chicago, IL)]; 1990. pp. viii, 120.
391. Riley RL, Cournand A. "Ideal" alveolar air and the analysis of ventilation-perfusion relationships in the lungs. *J Appl Physiol* 1949;1:825-847.
392. Anthonisen NR, Fleetham JA. Ventilation: total, alveolar, and dead space. In: Fishman AP, editor. Handbook of physiology. Section 3. The respiratory system: gas exchange. Bethesda, MD: American Physiological Society; 1987. p. 113-117.
393. Rahn H, Fenn WO. A graphical analysis of the respiratory gas exchange. Washington, DC: American Physiological Society; 1955.
394. Berlin S, Crapo R, Jensen RI. Negative alveolar-arterial oxygen gradients occur in healthy subjects and are not a sign of excessive blood gas measurement error [abstract]. *Am Rev Respir Dis* 1991;143:A763.
395. Hammond MD, Gale GE, Kapitan KS, Ries A, Wagner PD. Pulmonary gas exchange in humans during normobaric hypoxic exercise. *J Appl Physiol* 1986;61:1749-1757.
396. Dempsey JA, Hanson PG, Henderson KS. Exercise-induced arterial hypoxaemia in healthy human subjects at sea level. *J Physiol* 1984;355:161-175.
397. Wagner PD. Influence of mixed venous Po₂ on diffusion of O₂ across the pulmonary blood:gas barrier. *Clin Physiol* 1982;2:105-115.
398. Furuie AN, Sue DY, Hansen JE, Wasserman K. Comparison of physiologic dead space/tidal volume ratio and alveolar-arterial Po₂ difference during incremental and constant work exercise. *Am Rev Respir Dis* 1982;126:579-583.
399. Powers SK, Martin D, Cicale M, Collop N, Huang D, Criswell D. Exercise-induced hypoxemia in athletes: role of inadequate hyperventilation. *Eur J Appl Physiol Occup Physiol* 1992;65:37-42.
400. Zeballos RJ, Weisman IM, Johnson BD, Moreno A. P(a-a)O₂ during exercise in healthy young blacks with sickle cell trait (SCT) and controls. *Fed Proc* 1985;44:1368.
401. Johnson BD, Dempsey JA. Demand vs. capacity in the aging pulmonary system. *Exerc Sport Sci Rev* 1991;19:171-210.
402. Wagner PD, Gale GE, Moon RE, Torre-Bueno JR, Stolp BW, Saltzman HA. Pulmonary gas exchange in humans exercising at sea level and simulated altitude. *J Appl Physiol* 1986;61:260-270.
403. Martin TW, Zeballos RJ, Weisman IM. Use of arm crank exercise in the detection of abnormal pulmonary gas exchange in patients at low altitude. *Chest* 1992;102:169-175.
404. Donner CF, Patessio A, Casaburi R. Dynamics of acid-base regulation during exercise in patients with chronic obstructive lung disease. *Am Rev Respir Dis* 1991;143:A168.
405. Jones NL, McHardy GJ, Naimark A, Campbell EJ. Physiological dead space and alveolar-arterial gas pressure differences during exercise. *Clin Sci* 1966;31:19-29.
406. Mohsenifar Z, Brown HV, Koerner SK. Effect of breathing pattern on dead space ventilation V_D/V_T during exercise. *Respiration* 1985;47:232-236.
407. Bohr C. Ueber die lungenathmung. *Skand Arch Physiol* 1891;2:236-268.
408. Bouhuys A. Respiratory dead space. In: Fenn WO, Rahn H, editors. Handbook of physiology. Section III, Vol. 1. Respiration. Washington, DC: American Physiological Society; 1964. p. 699-714.
409. Mohsenifar Z, Tashkin DP, Levy SE, Bjerke RD, Clements PJ, Furst D. Lack of sensitivity of measurements of V_D/V_T at rest and during exercise in detection of hemodynamically significant pulmonary vascular abnormalities in collagen vascular disease. *Am Rev Respir Dis* 1981;123:508-512.
410. Mahler DA. Dyspnea. Armonk, NY: Futura; 1990. p. xiii.
411. Mahler DA. The measurement of dyspnea during exercise in patients with lung disease. *Chest* 1992;101(5 Suppl):242S-247S.
412. Aitken RC. Measurement of feelings using visual analogue scales. *Proc R Soc Med* 1969;62:989-993.
413. Gift AG. Visual analogue scales: measurement of subjective phenomena. *Nurs Res* 1989;38:286-288.
414. Borg GA. Psychophysical bases of perceived exertion. *Med Sci Sports Exerc* 1982;14:377-381.
415. Mahler DA, Faryniarz K, Lentine T, Ward J, Olmstead EM, O'Connor GT. Measurement of breathlessness during exercise in asthmatics: predictor variables, reliability, and responsiveness. *Am Rev Respir Dis* 1991;144:39-44.
416. Mahler DA, Guyatt GH, Jones PW. Clinical measurement of dyspnea. In: Mahler DA, editor. Lung biology in health and disease. Vol. III. Dyspnea. New York: Marcel Dekker; 1998. p. 149-198.
417. Shephard RJ. World standards of cardiorespiratory performance. *Arch Environ Health* 1966;13:664-672.
418. Becklake MR. Concepts of normality applied to the measurement of lung function. *Am J Med* 1986;80:1158-1164.
419. Jones NL, Summers E, Killian KJ. Influence of age and stature on exercise capacity during incremental cycle ergometry in men and women. *Am Rev Respir Dis* 1989;140:1373-1380.
420. Thacker SB. Meta-analysis: a quantitative approach to research integration. *JAMA* 1988;259:1685-1689.
421. Dehn MM, Bruce RA. Longitudinal variations in maximal oxygen intake with age and activity. *J Appl Physiol* 1972;33:805-807.
422. Pollock ML. The quantification of endurance training programs. In: Wilmore JH, editor. Exercise and sport sciences reviews. New York: Academic Press; 1973. p. 155-188.
423. Shvartz E, Reibold RC. Aerobic fitness norms for males and females aged 6 to 75 years: a review. *Aviat Space Environ Med* 1990;61:3-11.
424. Bailar JC III. The promise and problems of meta-analysis. *N Engl J Med* 1997;337:559-561.
425. Blackie SP, Fairbairn MS, McElvaney GN, Morrison NJ, Wilcox PG, Pardy RL. Prediction of maximal oxygen uptake and power during cycle ergometry in subjects older than 55 years of age. *Am Rev Respir Dis* 1989;139:1424-1429.
426. Neder JA, Nery LE, Castelo A, Andreoni S, Lerario MC, Sachs A, Silva AC, Whipp BJ. Prediction of metabolic and cardiopulmonary responses to maximum cycle ergometry: a randomised study. *Eur Respir J* 1999;14:1304-1313.
427. Jones NL, Makrides L, Hitchcock C, Chypchar T, McCartney N. Normal standards for an incremental progressive cycle ergometer test. *Am Rev Respir Dis* 1985;131:700-708.
428. Fairbairn MS, Blackie SP, McElvaney NG, Wiggs BR, Pare PD, Pardy RL. Prediction of heart rate and oxygen uptake during incremental and maximal exercise in healthy adults. *Chest* 1994;105:1365-1369.
429. Cotes JE, Berry G, Burkinshaw L, Davies CT, Hall AM, Jones PR, Knibbs AV. Cardiac frequency during submaximal exercise in young adults: relation to lean body mass, total body potassium and amount of leg muscle. *Q J Exp Physiol Cogn Med Sci* 1973;58:239-250.
430. Cotes JE. Response to progressive exercise: a three-index test. *Br J Dis Chest* 1972;66:169-184.
431. Inbar O, Oren A, Scheinowitz M, Rotstein A, Dlin R, Casaburi R. Normal cardiopulmonary responses during incremental exercise in 20- to 70-yr-old men. *Med Sci Sports Exerc* 1994;26:538-546.
432. Wagner PD, Hoppeler H, Saltin B. Determinants of maximal oxygen uptake. In: Crystal RG, West JB, editors. The lung: scientific foundations. New York: Raven Press; 1991. p. 1585-1593.
433. Rowell LB. Human circulation: regulation during physical stress. New York: Oxford University Press; 1986. p. x.
434. Saltin B, Strange S. Maximal oxygen uptake: "old" and "new" arguments for a cardiovascular limitation. *Med Sci Sports Exerc* 1992;24:30-37.
435. Dempsey JA. J.B. Wolfe memorial lecture: is the lung built for exercise? *Med Sci Sports Exerc* 1986;18:143-155.
436. Saltin B. Hemodynamic adaptations to exercise. *Am J Cardiol* 1985;55:42D-47D.
437. Janicki JS, Sheriff DD, Robotham JL, Wise RA. Cardiac output during exercise: contributions of the cardiac, circulatory and respiratory systems. In: Rowell LB, Shepard JT, editors. Handbook of Physiology. Section 12. Exercise: regulation and integration of multiple systems. New York: Oxford University Press; 1996. p. 649-704.
438. Mancini DM. Pulmonary factors limiting exercise capacity in patients with heart failure. *Prog Cardiovasc Dis* 1995;37:347-370.
439. Mancini DM, Walter G, Reichel N, Lenkinski R, McCully KK, Mullen JL, Wilson JR. Contribution of skeletal muscle atrophy to exercise intolerance and altered muscle metabolism in heart failure. *Circulation* 1992;85:1364-1373.
440. Killian KJ, Jones NL. Mechanisms of exertional dyspnea. *Clin Chest Med* 1994;15:247-257.
441. Light RW, Mintz HM, Linden GS, Brown SE. Hemodynamics of patients with severe chronic obstructive pulmonary disease during progressive upright exercise. *Am Rev Respir Dis* 1984;130:391-395.
442. Mahler DA, Brent BN, Loke J, Zaret BL, Matthay RA. Right ventricular performance and central circulatory hemodynamics during upright exercise in patients with chronic obstructive pulmonary disease. *Am Rev Respir Dis* 1984;130:722-729.

443. Weisman IM, Connery SM, Belbel RJ, Zeballos RJ. The role of cardiopulmonary exercise testing in the selection of patients for cardiac transplantation. *Chest* 1992;102:1871-1874.
444. Shepard RJ, Bouhleil E, Vandewalle H, Monod H. Muscle mass as a factor limiting physical work. *J Appl Physiol* 1988;64:1472-1479.
445. Gosselink R, Troosters T, Decramer M. Peripheral muscle weakness contributes to exercise limitation in COPD. *Am J Respir Crit Care Med* 1996;153:976-980.
446. Jakobsson P, Jorfeldt L, Henriksson J. Metabolic enzyme activity in the quadriceps femoris muscle in patients with severe chronic obstructive pulmonary disease. *Am J Respir Crit Care Med* 1995;151:374-377.
447. Debigare R, Cote CH, Maltais F. Peripheral muscle wasting in chronic obstructive pulmonary disease. *Am J Respir Crit Care Med* 2001;164:1712-1717.
448. Neuberg GW, Friedman SH, Weiss MB, Herman MV. Cardiopulmonary exercise testing: the clinical value of gas exchange data. *Arch Intern Med* 1988;148:2221-2226.
449. Zavala DC. Manual on exercise testing: a training handbook, 3rd ed. Iowa City, IA: University of Iowa; 1993.
450. Babb TG, Viggiano R, Hurler B, Staats B, Rodarte JR. Effect of mild-to-moderate airflow limitation on exercise capacity. *J Appl Physiol* 1991;70:223-230.
451. Babb TG, Rodarte JR. Estimation of ventilatory capacity during submaximal exercise. *J Appl Physiol* 1993;74:2016-2022.
452. Mejia R, Ward J, Lentine T, Mahler DA. Target dyspnea ratings predict expected oxygen consumption as well as target heart rate values. *Am J Respir Crit Care Med* 1999;159:1485-1489.
453. Mador MJ, Rodis A, Magalang UJ. Reproducibility of Borg Scale measurements of dyspnea during exercise in patients with COPD. *Chest* 1995;107:1590-1597.
454. Younes M. Interpretation of clinical exercise testing in respiratory disease. *Clin Chest Med* 1984;5:189-206.
455. Riddle W, Younes M, Remmers J. Graphical analysis of patient performance in the pulmonary function laboratory. In: Fourth annual symposium on computer applications in medical care. Los Alamitos, CA: IEEE Computer Society; 1980. p. 282-290.
456. Ramos-Barbon D, Fitchett D, Gibbons WJ, Latter DA, Levy RD. Maximal exercise testing for the selection of heart transplantation candidates: limitation of peak oxygen consumption. *Chest* 1999;115:410-417.
457. Shepard RJ. Tests of maximum oxygen intake: a critical review. *Sports Med* 1984;1:99-124.
458. Mahler DA, Horowitz MB. Clinical evaluation of exertional dyspnea. *Clin Chest Med* 1994;15:259-269.
459. Weber KT, Wilson JR, Janicki JS, Likoff MJ. Exercise testing in the evaluation of the patient with chronic cardiac failure. *Am Rev Respir Dis* 1984;129:S60-S62.
460. Sullivan MJ, Hawthorne MH. Exercise intolerance in patients with chronic heart failure. *Prog Cardiovasc Dis* 1995;38:1-22.
461. Franciosa JA, Ziesche S, Wilen M. Functional capacity of patients with chronic left ventricular failure: relationship of bicycle exercise performance to clinical and hemodynamic characterization. *Am J Med* 1979;67:460-466.
462. Wilson JR, Ferraro N. Exercise intolerance in patients with chronic left heart failure: relation to oxygen transport and ventilatory abnormalities. *Am J Cardiol* 1983;51:1358-1363.
463. Myers J, Froelicher VF. Hemodynamic determinants of exercise capacity in chronic heart failure. *Ann Intern Med* 1991;115:377-386.
464. Wiener DH, Fink LI, Maris J, Jones RA, Chance B, Wilson JR. Abnormal skeletal muscle bioenergetics during exercise in patients with heart failure: role of reduced muscle blood flow. *Circulation* 1986;73:1127-1136.
465. Lipkin DP, Jones DA, Round JM, Poole-Wilson PA. Abnormalities of skeletal muscle in patients with chronic heart failure. *Int J Cardiol* 1988;18:187-195.
466. Sullivan MJ, Duscha BD, Slentz CA. Peripheral determinants of exercise intolerance in patients with chronic heart failure. In: Wasserman K, editor. Exercise gas exchange in heart disease. Armonk, NY: Futura; 1996.
467. Sullivan MJ, Higginbotham MB, Cobb FR. Increased exercise ventilation in patients with chronic heart failure: intact ventilatory control despite hemodynamic and pulmonary abnormalities. *Circulation* 1988;77:552-559.
468. Jones S, Elliott PM, Sharma S, McKenna WJ, Whipp BJ. Cardiopulmonary responses to exercise in patients with hypertrophic cardiomyopathy. *Heart* 1998;80:60-67.
469. Nery LE, Wasserman K, French W, Oren A, Davis JA. Contrasting cardiovascular and respiratory responses to exercise in mitral valve and chronic obstructive pulmonary diseases. *Chest* 1983;83:446-453.
470. Francis GS, Goldsmith SR, Ziesche S, Nakajima H, Cohn JN. Relative attenuation of sympathetic drive during exercise in patients with congestive heart failure. *J Am Coll Cardiol* 1985;5:832-839.
471. Nishime EO, Cole CR, Blackstone EH, Pashkow FJ, Lauer MS. Heart rate recovery and treadmill exercise score as predictors of mortality in patients referred for exercise ECG. *JAMA* 2000;284:1392-1398.
472. Banning AP, Lewis NP, Northridge DB, Elborn JS, Hendersen AH. Perfusion/ventilation mismatch during exercise in chronic heart failure: an investigation of circulatory determinants. *Br Heart J* 1995;74:27-33.
473. Johnson BD, Beck KC, Olson LJ, O'Malley KA, Allison TG, Squires RW, Gau GT. Ventilatory constraints during exercise in patients with chronic heart failure. *Chest* 2000;117:321-332.
474. Buller NP, Poole-Wilson PA. Mechanism of the increased ventilatory response to exercise in patients with chronic heart failure. *Br Heart J* 1990;63:281-283.
475. Theodore J, Robin ED, Morris AJ, Burke CM, Jamieson SW, Van Kessel A, Stinson EB, Shumway NE. Augmented ventilatory response to exercise in pulmonary hypertension. *Chest* 1986;89:39-44.
476. Gallagher CG, Younes M. Breathing pattern during and after maximal exercise in patients with chronic obstructive lung disease, interstitial lung disease, and cardiac disease, and in normal subjects. *Am Rev Respir Dis* 1986;133:581-586.
477. Chauhan A, Sridhar G, Clemens R, Krishnan B, Marciniuk DD, Gallagher CG. Role of respiratory function in exercise limitation in chronic heart failure. *Chest* 2000;118:53-60.
478. Sudduth CD, Strange C, Cook WR, Miller KS, Baumann M, Collop NA, Silver RM. Failure of the circulatory system limits exercise performance in patients with systemic sclerosis. *Am J Med* 1993;95:413-418.
479. D'Alonzo GE, Gianotti LA, Pohil RL, Reagle RR, DuRee SL, Fuentes F, Dantzker DR. Comparison of progressive exercise performance of normal subjects and patients with primary pulmonary hypertension. *Chest* 1987;92:57-62.
480. Saltin B, Blomqvist G, Mitchell JH, Johnson RL Jr, Wildenthal K, Chapman CB. Response to exercise after bed rest and after training. *Circulation* 1968;38(5 Suppl):VII1-VII78.
481. Saltin B. Physiological effects of physical conditioning. *Med Sci Sports* 1969;1:50-56.
482. Taivassalo T, De Stefano N, Chen J, Karpati G, Arnold DL, Argov Z. Short-term aerobic training response in chronic myopathies. *Muscle Nerve* 1999;22:1239-1243.
483. Siciliano G, Manca ML, Renna M, Prontera C, Mercuri A, Murri L. Effects of aerobic training on lactate and catecholaminergic exercise responses in mitochondrial myopathies. *Neuromuscul Disord* 2000;10:40-45.
484. Carter R, Nicotra B, Blevins W, Holiday D. Altered exercise gas exchange and cardiac function in patients with mild chronic obstructive pulmonary disease. *Chest* 1993;103:745-750.
485. Marciniuk DD, Gallagher CG. Clinical exercise testing in chronic airflow limitation. *Med Clin North Am* 1996;80:565-587.
486. Jones NL, Jones G, Edwards RH. Exercise tolerance in chronic airway obstruction. *Am Rev Respir Dis* 1971;103:477-491.
487. Levison H, Cherniack RM. Ventilatory cost of exercise in chronic obstructive pulmonary disease. *J Appl Physiol* 1968;25:21-27.
488. Yan S, Kaminski D, Sliwinski P. Reliability of inspiratory capacity for estimating end-expiratory lung volume changes during exercise in patients with chronic obstructive pulmonary disease. *Am J Respir Crit Care Med* 1997;156:55-59.
489. O'Donnell DE. Exercise limitation and clinical exercise testing in chronic obstructive pulmonary disease. In: Weisman IM, Zeballos RJ, editors. Progress in respiratory research. Vol. 32. Clinical exercise testing. Basel, Switzerland: Karger; 2002. p. 138-158.
490. O'Donnell DE, D'Arsigney C, Webb KA. Effects of hyperoxia on ventilatory limitation during exercise in advanced chronic obstructive pulmonary disease. *Am J Respir Crit Care Med* 2001;163:892-898.
491. LoRusso TJ, Belman MJ, Elashoff JD, Koerner SK. Prediction of maximal exercise capacity in obstructive and restrictive pulmonary disease. *Chest* 1993;104:1748-1754.
492. Montes de Oca M, Rassulo J, Celli BR. Respiratory muscle and cardiopulmonary function during exercise in very severe COPD. *Am J Respir Crit Care Med* 1996;154:1284-1289.
493. O'Donnell DE, D'Arsigney C, Fitzpatrick M, Webb KA. Exercise hypercapnia in advanced chronic obstructive pulmonary disease. *Am J Respir Crit Care Med* 2002;166:663-668.
494. Dempsey JA. Exercise carbon dioxide retention in chronic obstructive pulmonary disease: a case for ventilation/perfusion mismatch combined with hyperinflation. *Am J Respir Crit Care Med* 2002;166:634-635.

495. Raffestin B, Escourrou P, Legrand A, Duroux P, Lockhart A. Circulatory transport of oxygen in patients with chronic airflow obstruction exercising maximally. *Am Rev Respir Dis* 1982;125:426-431.
496. Spiro SG, Hahn HL, Edwards RH, Pride NB. An analysis of the physiological strain of submaximal exercise in patients with chronic obstructive bronchitis. *Thorax* 1975;30:415-425.
497. Wagner PD. Ventilation-perfusion matching during exercise. *Chest* 1992;101(5 Suppl):192S-198S.
498. Agusti AG, Barbera JA, Roca J, Wagner PD, Guitart R, Rodriguez-Roisin R. Hypoxic pulmonary vasoconstriction and gas exchange during exercise in chronic obstructive pulmonary disease. *Chest* 1990;97:268-275.
499. Barbera JA, Roca J, Ramirez J, Wagner PD, Ussetti P, Rodriguez-Roisin R. Gas exchange during exercise in mild chronic obstructive pulmonary disease: correlation with lung structure. *Am Rev Respir Dis* 1991;144:520-525.
500. Burdon JG, Killian KJ, Jones NL. Pattern of breathing during exercise in patients with interstitial lung disease. *Thorax* 1983;38:778-784.
501. Jones N. Determinants of breathing pattern in exercise. In: Whipp BJ, Wasserman K, editors. Exercise pulmonary physiology and pathophysiology. New York: Marcel Dekker; 1991. p. 99-119.
502. Gowda K, Zintel T, McParland C, Orchard R, Gallagher CG. Diagnostic value of maximal exercise tidal volume. *Chest* 1990;98:1351-1354.
503. Jones NL, Rebuck AS. Tidal volume during exercise in patients with diffuse fibrosing alveolitis. *Bull Eur Physiopathol Respir* 1979;15:321-328.
504. Agusti AG, Roca J, Gea J, Wagner PD, Xaubet A, Rodriguez-Roisin R. Mechanisms of gas-exchange impairment in idiopathic pulmonary fibrosis. *Am Rev Respir Dis* 1991;143:219-225.
505. Denison D, Al-Hillawi H, Turton C. Lung function in interstitial lung disease. *Semin Respir Med* 1984;6:40-54.
506. Nordenfelt I, Svensson G. The transfer factor (diffusing capacity) as a predictor of hypoxaemia during exercise in restrictive and chronic obstructive pulmonary disease. *Clin Physiol* 1987;7:423-430.
507. Bradvik I, Wollmer P, Blom-Bulow B, Albrechtsson U, Jonson B. Lung mechanics and gas exchange during exercise in pulmonary sarcoidosis. *Chest* 1991;99:572-578.
508. Harris-Eze AO, Sridhar G, Clemens RE, Zintel TA, Gallagher CG, Marciniuk DD. Role of hypoxemia and pulmonary mechanics in exercise limitation in interstitial lung disease. *Am J Respir Crit Care Med* 1996;154:994-1001.
509. Spiro SG, Dowdeswell IR, Clark TJ. An analysis of submaximal exercise responses in patients with sarcoidosis and fibrosing alveolitis. *Br J Dis Chest* 1981;75:169-180.
510. Dunn TL, Watters LC, Hendrix C, Cherniack RM, Schwarz MI, King TE Jr. Gas exchange at a given degree of volume restriction is different in sarcoidosis and idiopathic pulmonary fibrosis. *Am J Med* 1988;85:221-224.
511. Wells AU, Hansell DM, Rubens MB, Cailles JB, Black CM, du Bois RM. Functional impairment in lone cryptogenic fibrosing alveolitis and fibrosing alveolitis associated with systemic sclerosis: a comparison. *Am J Respir Crit Care Med* 1997;155:1657-1664.
512. Weitzenblum E, Ehrhart M, Rasaholinjanahary J, Hirth C. Pulmonary hemodynamics in idiopathic pulmonary fibrosis and other interstitial pulmonary diseases. *Respiration* 1983;44:118-127.
513. Sietsema KE, Kraft M, Ginzton L, Sharma OP. Abnormal oxygen uptake responses to exercise in patients with mild pulmonary sarcoidosis. *Chest* 1992;102:838-845.
514. Gibbons WJ, Levy RD, Nava S, Malcolm I, Marin JM, Tardif C, Magder S, Lisbona R, Cosio MG. Subclinical cardiac dysfunction in sarcoidosis. *Chest* 1991;100:44-50.
515. Baughman RP, Gerson M, Bosken CH. Right and left ventricular function at rest and with exercise in patients with sarcoidosis. *Chest* 1984;85:301-306.
516. Bush A, Busst CM. Cardiovascular function at rest and on exercise in patients with cryptogenic fibrosing alveolitis. *Thorax* 1988;43:276-283.
517. Sturani C, Papiris S, Galavotti V, Gunella G. Pulmonary vascular responsiveness at rest and during exercise in idiopathic pulmonary fibrosis: effects of oxygen and nifedipine. *Respiration* 1986;50:117-129.
518. Salvadori A, Fanari P, Fontana M, Buontempi L, Saezza A, Baudo S, Miserocchi G, Longhini E. Oxygen uptake and cardiac performance in obese and normal subjects during exercise. *Respiration* 1999;66:25-33.
519. Zarich SW, Kowalchuk GJ, McGuire MP, Benotti PN, Mascioli EA, Nesto RW. Left ventricular filling abnormalities in asymptomatic morbid obesity. *Am J Cardiol* 1991;68:377-381.
520. Babb TG, Buskirk ER, Hodgson JL. Exercise end-expiratory lung volumes in lean and moderately obese women. *Int J Obes* 1989;13:11-19.
521. Chiba M, Beck K, Scanlon P, Staats BA, Mottram CD. Cardiopulmonary exercise testing in pseudoasthma associated with obesity. *Am J Respir Crit Care Med* 1996;153:A513.
522. Sakamoto S, Ishikawa K, Senda S, Nakajima S, Matsuo H. The effect of obesity on ventilatory response and anaerobic threshold during exercise. *J Med Syst* 1993;17:227-231.
523. Ray CS, Sue DY, Bray G, Hansen JE, Wasserman K. Effects of obesity on respiratory function. *Am Rev Respir Dis* 1983;128:501-506.
524. Magarian GJ. Hyperventilation syndromes: infrequently recognized common expressions of anxiety and stress. *Medicine (Baltimore)* 1982;61:219-236.
525. Gardner WN. The pathophysiology of hyperventilation disorders. *Chest* 1996;109:516-534.
526. Gardner WN, Meah MS, Bass C. Controlled study of respiratory responses during prolonged measurement in patients with chronic hyperventilation. *Lancet* 1986;2:826-830.
527. Kinnula VL, Sovijarvi AR. Elevated ventilatory equivalents during exercise in patients with hyperventilation syndrome. *Respiration* 1993;60:273-278.
528. Lary D, Goldschlager N. Electrocardiographic changes during hyperventilation resembling myocardial ischemia in patients with normal coronary arteriograms. *Am Heart J* 1974;87:383-390.
529. Mahler DA, Moritz ED, Loke J. Exercise performance in marathon runners with airway obstruction. *Med Sci Sports Exerc* 1981;13:284-289.
530. Green HJ, Patla AE. Maximal aerobic power: neuromuscular and metabolic considerations. *Med Sci Sports Exerc* 1992;24:38-46.
531. Simel DL, Samsa GP, Matchar DB. Likelihood ratios with confidence: sample size estimation for diagnostic test studies. *J Clin Epidemiol* 1991;44:763-770.
532. Evidence-based Medicine Working Group. Evidence-based medicine: a new approach to the teaching of medicine. *JAMA* 1992;268:2420-2425.
533. Bruce RA, Kusumi F, Hosmer D. Maximal oxygen intake and nomographic assessment of functional aerobic impairment in cardiovascular disease. *Am Heart J* 1973;85:546-562.
534. Froelicher VF Jr, Allen M, Lancaster MC. Maximal treadmill testing of normal USAF airmen. *Aerosp Med* 1974;45:310-315.
535. Drinkwater BL, Horvath SM, Wells CL. Aerobic power of females, ages 10 to 68. *J Gerontol* 1975;30:385-394.
536. Vogel JA, Patton JF, Mello RP, Daniels WL. An analysis of aerobic capacity in a large United States population. *J Appl Physiol* 1986;60:494-500.
537. Storer TW, Davis JA, Caiozzo VJ. Accurate prediction of $\dot{V}O_{2max}$ in cycle ergometry. *Med Sci Sports Exerc* 1990;22:704-712.
538. Wasserman K, Van Kessel AL, Burton GG. Interaction of physiological mechanisms during exercise. *J Appl Physiol* 1967;22:71-85.
539. Hansen JE, Vogel JA, Stelter GP, Consolazio CF. Oxygen uptake in man during exhaustive work at sea level and high altitude. *J Appl Physiol* 1967;23:511-522.
540. Hartley LH, Grimby G, Kilbom A, Nilsson NJ, Astrand I, Bjure J, Ekblom B, Saltin B. Physical training in sedentary middle-aged and older men. 3. Cardiac output and gas exchange at submaximal and maximal exercise. *Scand J Clin Lab Invest* 1969;24:335-344.
541. Whipp BJ, Wasserman K. Alveolar-arterial gas tension differences during graded exercise. *J Appl Physiol* 1969;27:361-365.
542. Dempsey JA, Reddan WG, Birnbaum ML, Forster HV, Thoden JS, Grover RF, Rankin J. Effects of acute through life-long hypoxic exposure on exercise pulmonary gas exchange. *Respir Physiol* 1971;13:62-89.
543. Bradley CA, Harris EA, Seelye ER, Whitlock RM. Gas exchange during exercise in healthy people. I. The physiological dead-space volume. *Clin Sci Mol Med* 1976;51:323-333.
544. Malmberg P, Hedenstrom H, Fridriksson HV. Reference values for gas exchange during exercise in healthy nonsmoking and smoking men. *Bull Eur Physiopathol Respir* 1987;23:131-138.
545. Sue DY, Hansen JE. Normal values in adults during exercise testing. *Clin Chest Med* 1984;5:89-98.